

DIRIS A-30/A-41/A-60

2 Outputs 0/4 - 20 mA

Notice d'utilisation
Operating instructions - Bedienungsanleitung
Istruzioni per l'uso - Gebruiksaanwijzing
Instrucciones de servicio - Manual de instruções

FR EN DE IT NL ES PT

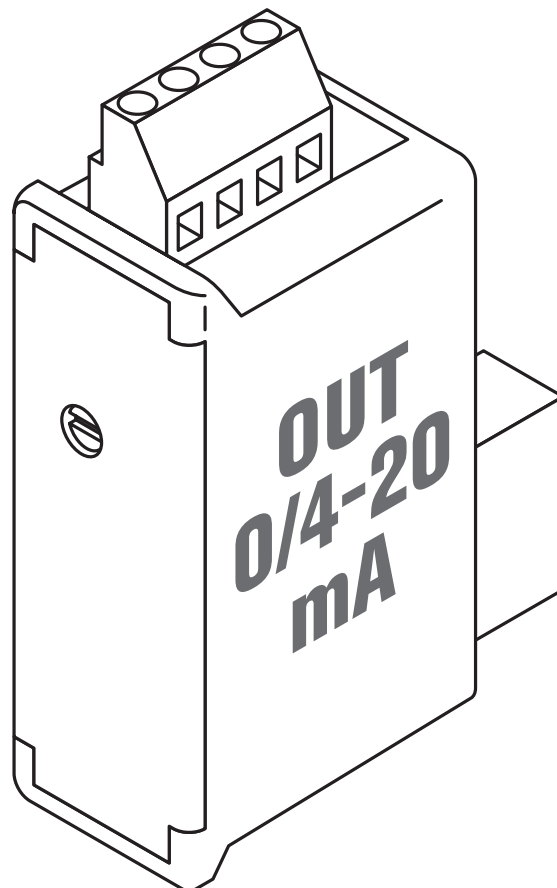

FR

Sommaire

OPÉRATIONS PRÉALABLES	4
PRÉSENTATION.....	5
INSTALLATION.....	6
PROGRAMMATION.....	8
CARACTÉRISTIQUES TECHNIQUES.....	19

EN

Contents

PRELIMINARY OPERATIONS	4
PRESENTATION.....	5
INSTALLATION.....	6
PROGRAMMING	8
TECHNICAL CHARACTERISTICS.....	19

DE

Inhaltsverzeichnis

VORAUSGEHENDE KONTROLLEN.....	4
PRODUKTDARSTELLUNG.....	5
INSTALLATION.....	6
KONFIGURATION	8
TECHNISCHE DATEN	19

IT

Sommaio

OPERAZIONI PRELIMINARI.....	4
PRESENTAZIONE	5
INSTALLAZIONE	6
PROGRAMMAZIONE	8
CARATTERISTICHE TECNICHE	19

NL

Inhoud

VOORAFGAANDE HANDELINGEN	4
PRESENTATIE	5
INSTALLERING	6
PROGRAMMERING	8
TECHNISCHE EIGENSCHAPPEN	19

ES

Índice

OPERACIONES PREVIAS	4
PRESENTACIÓN	5
INSTALACIÓN	6
PROGRAMACIÓN	8
CARACTERÍSTICAS TÉCNICAS	19

PT

Índice

OPERAÇÕES PRELIMINARES.....	4
APRESENTAÇÃO	5
INSTALAÇÃO	6
PROGRAMAÇÃO	8
CARACTERÍSTICAS TÉCNICAS	19

DIRIS A-30/A-41/A-60 - 2 Outputs 0/4 - 20 mA

OPÉRATIONS PRÉALABLES

PRELIMINARY OPERATIONS - VORAUSGEHENDE KONTROLLEN

OPERAZIONI PRELIMINARI - VOORAGAANDE HANDELINGEN

OPERACIONES PREVIAS - OPERAÇÕES PRELIMINARES

F

Au moment de la réception du colis contenant le module option, il est nécessaire de vérifier les points suivants :

- l'état de l'emballage,
- le produit n'a pas eu de dommage pendant le transport,
- la référence de l'appareil est conforme à votre commande,
- l'emballage comprend le produit,
- une notice d'utilisation.

NL

Als u het pakket met de optie-module ontvangt, dient u de volgende punten te controleren:

- de staat van de verpakking;
- of het product geen schade heeft geleden tijdens het transport;
- of de referentie van het toestel overeenkomt met de bestelling;
- de verpakking bevat een product;
- of de gebruiksaanwijzing aanwezig is.

GB

When the package containing the optional module is received, the following points must be checked:

- the packing is in good condition,
- the product has not been damaged during transit,
- the product reference number conforms to your order,
- the package contains the product,
- the operating instructions.

E

En el momento de recibir el paquete que contiene el módulo opcional, es necesario comprobar los siguientes puntos:

- estado del embalaje;
- que el producto no se haya dañado durante el transporte;
- que la referencia del Aparato esté conforme con su pedido;
- el embalaje incluye el producto;
- el manual de utilización.

D

Sobald das Versandpaket bei Ihnen eintrifft, sollten Sie Folgendes überprüfen:

- Zustand der Verpackung,
- Sind Transportschäden zu melden,
- Entspricht der Packungsinhalt Ihrer Bestellung,
- Die Verpackung enthält das Produkt,
- Eine Bedienungsanleitung ist beigelegt.

P

Na altura da recepção da encomenda que contém o módulo opção, devem ser verificados os seguintes pontos:

- o estado da embalagem;
- se o produto não foi danificado durante o transporte;
- se a referência do Aparelho está acordo com a sua encomenda;
- dentro da embalagem encontrase realmente o produto;
- se existe um manual de utilização.

I

Al momento della ricezione del pacchetto con il modulo opzione, è necessario verificare i seguenti punti:

- lo stato dell'imballo;
- la presenza di danneggiamenti o rotture dovuti al trasporto;
- se il numero di riferimento dell'apparecchio è conforme a quello della richiesta;
- l'imballaggio comprende il prodotto;
- la presenza del libretto di istruzione originale.

PRÉSENTATION

PRESENTATION - PRODUKTDARSTELLUNG - PRESENTAZIONE

PRESENTATIE - PRESENTACIÓN - APRESENTAÇÃO

F

Ce module option doit être connecté aux **DIRIS A-30/A-41/A-60** (réf. 48250402, 48250403, 48250404, 48250405, 48250406). Il met à disposition 2 sorties analogiques 0/4 – 20 U12, U23, U31, V1, V2, V3, ΣP , ΣQ , ΣS , ΣPF^{LC} , F, Isys, Usys, Vsys, Ppr, Qpr, Spr, T°C1, T°C2, T°C3 et T°C4 interne. On peut également utiliser la sortie alimentation en utilisant la fonction 30 V.

On peut avoir au maximum 2 modules, soit 4 sorties analogiques sur un même **DIRIS A-30/A-41/A-60**.

NL

Deze optiemodule moet worden aangesloten op de **DIRIS A-30/A-41/A-60** (ref. 48250402, 48250403, 48250404, 48250405, 48250406). Het biedt 2 analoge geheel configureerbare uitgangen 0 / 4 - 20 mA (drempel op 0 of 4 mA en drempel op 20 mA) op I1, I2, I3, In, U12, U23, U31, V1, V2, V3, ΣP , ΣQ , ΣS , ΣPF^{LC} , F, Isys, Usys, Vsys, Ppr, Qpr, Spr, T°C1, T°C2, T°C3 en T°C4 interne. Men kan ook de voedingsuitgang gebruiken met de 30 V functie.

Men kan maximaal 2 modules hebben, of wel 4 analoge uitgangen op een zelfde **DIRIS A-30/A-41/A-60**.

GB

This optional module must be connected to the **DIRIS A-30/A-41/A-60** (ref. 48250402, 48250403, 48250404, 48250405, 48250406). It provides 2 entirely configurable 0/4-20 mA analog outputs (threshold at 0 or 4 mA and threshold at 20 mA) on I1, I2, I3, In, U12, U23, U31, V1, V2, V3, ΣP , ΣQ , ΣS , ΣPF^{LC} , F, Isys, Usys, Vsys, Ppr, Qpr, Spr, T°C1, T°C2, T°C3 and T°C4 internal. The power supply output can also be used using the 30 V function.

Up to a maximum of 2 modules, that is 4 analog outputs installed on one **DIRIS A-30/A-41/A-60**.

E

Este módulo opcional se debe conectar a los modelos **DIRIS A-30/A-41/A-60** (ref. 48250402, 48250403, 48250404, 48250405, 48250406). Pone a disposición 2 salidas analógicas 0 / 4 - 20 mA totalmente configurables (umbral a 0 o 4 mA y umbral a 20 mA) en I1, I2, I3, In, U12, U23, U31, V1, V2, V3, ΣP , ΣQ , ΣS , ΣPF^{LC} , F, Isys, Usys, Vsys, Ppr, Qpr, Spr, T°C1, T°C2, T°C3 y T°C4 interna. También se puede utilizar la salida de alimentación con la función 30 V. Se puede disponer de 2 módulos como máximo, ya sea 4 salidas analógicas en un mismo **DIRIS A-30/A-41/A-60**.

D

Dieses Optionsmodul muss an **DIRIS A-30/A-41/A-60** (ref. 48250402, 48250403, 48250404, 48250405, 48250406) angeschlossen sein. Es bietet 2 vollständig konfigurierbare Analogausgänge (0 / 4 - 20 mA, mit Schwelle bei 0 oder 4 mA und Schwelle bei 20 mA) auf I1, I2, I3, In, U12, U23, U31, V1, V2, V3, ΣP , ΣQ , ΣS , ΣPF^{LC} , F, Isys, Usys, Vsys, Ppr, Qpr, Spr, T°C1, T°C2, T°C3 und T°C4 interne. Der Versorgungsausgang kann auch unter Verwendung der 30-V-Funktion genutzt werden. Möglich sind maximal 2 Module und somit 4 Analogausgänge an ein und demselben **DIRIS A-30/A-41/A-60**.

P

Este módulo opção deve ser ligado aos **DIRIS A-30/A-41/A-60** (ref. 48250402, 48250403, 48250404, 48250405, 48250406). Coloca à sua disposição 2 saídas analógicas 0 / 4 - 20 mA inteiramente configuráveis (limite a 0 ou 4 mA e limite a 20 mA) em I1, I2, I3, In, U12, U23, U31, V1, V2, V3, ΣP , ΣQ , ΣS , ΣPF^{LC} , F, Isys, Usys, Vsys, Ppr, Qpr, Spr, T°C1, T°C2, T°C3 e T°C4 interna. Podemos igualmente utilizar a saída alimentação utilizando a função 30 V. É possível termos no máximo 2 módulos, ou seja 4 saídas analógicas num mesmo **DIRIS A-30/A-41/A-60**.

I

Questo modulo opzione deve essere collegato ai **DIRIS A-30/A-41/A-60** (ref. 48250402, 48250403, 48250404, 48250405, 48250406). Mette a disposizione 2 uscite analogiche 0 / 4 - 20 mA interamente configurabili (soglia a 0 o 4 mA e soglia a 20 mA) su I1, I2, I3, In, U12, U23, U31, V1, V2, V3, ΣP , ΣQ , ΣS , ΣPF^{LC} , F, Isys, Usys, Vsys, Ppr, Qpr, Spr, T°C1, T°C2, T°C3 e T°C4 interna. Si può anche usare l'uscita dell'alimentazione utilizzando la funzione 30 V.

Si possono avere al massimo 2 moduli, ossia 4 uscite analogiche su uno stesso **DIRIS A-30/A-41/A-60**.

INSTALLATION

INSTALLATION - INSTALLATION - INSTALLAZIONE
INSTALLERING - INSTALACIÓN - INSTALAÇÃO

RACCORDEMENT

- EN** Connection
- DE** Anschluß
- IT** Collegamento
- NL** Aansluiting
- ES** Parte trasera
- PT** Ligação

Le DIRIS A-30/A-41/A-60 doit être hors tension.
This DIRIS A-30/A-41/A-60 must be switched off.
Der DIRIS A-30/A-41/A-60 darf nicht unter Spannung stehen.
Il DIRIS A-30/A-41/A-60 deve essere fuori tensione.
De DIRIS A-30/A-41/A-60 moet zonder spanning staan.
El DIRIS A-30/A-41/A-60 deberá estar desconectado.
O DIRIS A-30/A-41/A-60 deve ficar desligado.

1

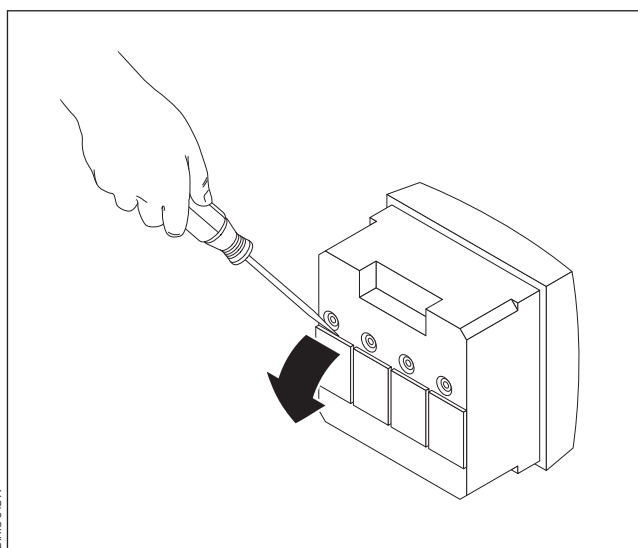

2

Fixer le module - Fix the module - Befestigen Sie das Modu - Fissare il modulo - Bevestig de module - Fije el módulo - Fixe o módulo

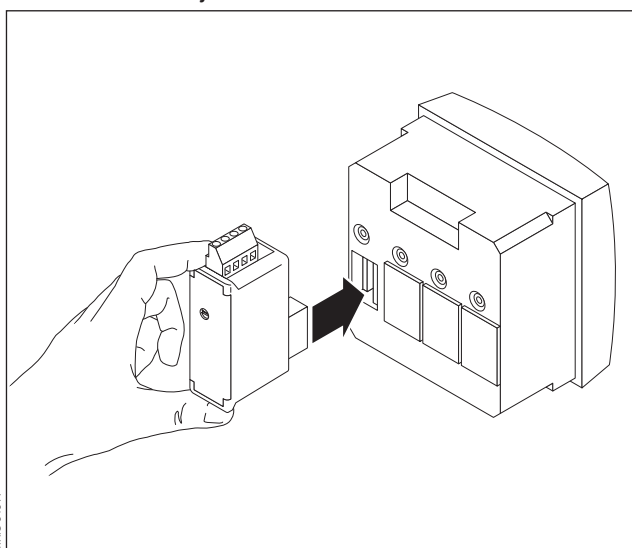

3

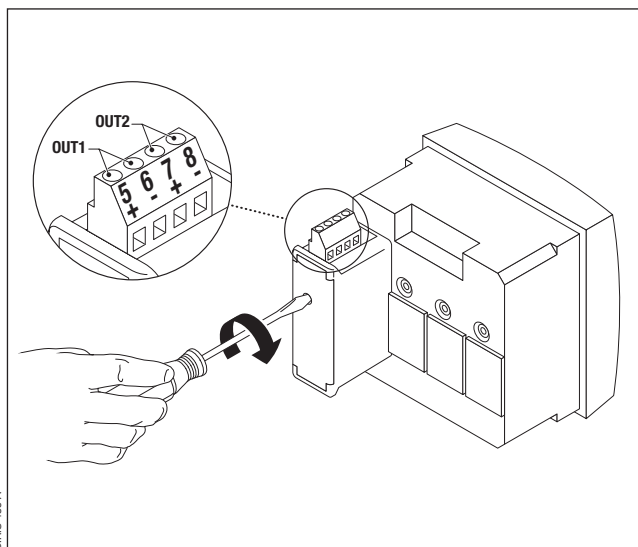

RACCORDEMENT

- EN** Connection
- DE** Anschluß
- IT** Collegamento
- NL** Aansluiting
- ES** Parte trasera
- PT** Ligação

Le DIRIS A-30/A-41/A-60 doit être hors tension.
This DIRIS A-30/A-41/A-60 must be switched off.
Der DIRIS A-30/A-41/A-60 darf nicht unter Spannung stehen.
Il DIRIS A-30/A-41/A-60 deve essere fuori tensione.
De DIRIS A-30/A-41/A-60 moet zonder spanning staan.
El DIRIS A-30/A-41/A-60 deberá estar desconectado.
O DIRIS A-30/A-41/A-60 deve ficar desligado.

4

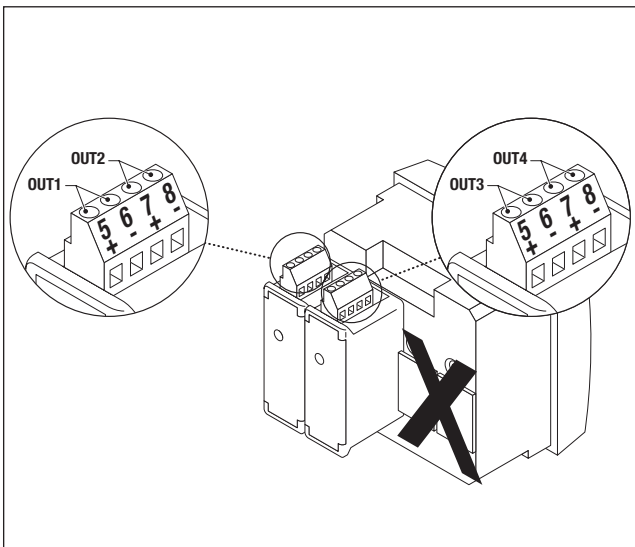

Lors de l'utilisation de quatre sorties, l'installation des deux modules doit se faire sur les deux emplacements de gauche comme indiqué.

When using the four outputs, the two modules must be installed in the two left-hand positions as shown.

Bei der Verwendung von vier Ausgängen muss die Installation der zwei Module wie angegeben an den zwei linken Plätzen erfolgen.

Al momento dell'utilizzazione delle quattro uscite, l'installazione dei due moduli deve farsi sui due spazi di sinistra come indicato.

Bij het gebruik van vier uitgangen, moet de installatie van de twee modules gebeuren op de twee linker plaatsen, zoals aangegeven.

Al utilizar las cuatro salidas, la instalación de los dos módulos se hará en los dos emplazamientos de la izquierda como se indica.

Durante a utilização das quatro saídas, a instalação dos dois módulos devem fazer-se nas duas localizações da esquerda como indicado.

5

**Raccorder le bornier en respectant les indications.
Remettre sous tension**

*Follow indications when connecting the terminal.
Switch on voltage supply.*

Für den Anschluß der Klemmleiste beachten Sie die entsprechenden Hinweise. Wieder einschalten.

*Raccordare i morsetti rispettando le indicazioni.
Alimentare il **DIRIS A-30/A-41/A-60**.*

*De klemmenstrook aansluiten zoals aangegeven.
Terug spanning geven.*

*Conexionar respetando las indicaciones.
Poner en tensión*

Ligar o terminal de bornes respeitando as indicações. Colocar sob tensão novamente.

PROGRAMMATION

PROGRAMMING - KONFIGURATION - PROGRAMMAZIONE

PROGRAMMERING - PROGRAMACIÓN - PROGRAMACÃO

*Previous menu - Vorhergehendes Menü - Menu precedente
Menu voorgaand - Menú anterior - Menu precedente*

Menu précédent

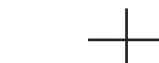
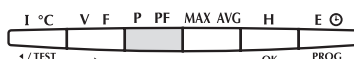

— p.9



— p.11



— p.13



— p.15



— p.16



— p.16



— p.16



Menu suivant

*Following menu - Nachfolgender Menü - Menu seguire -
Menu volgend - Menú siguiente - Menu seguir*

TYPE DE LA SORTIE ANALOGIQUE N° 1 - Exemple : TYPE = 0 / 20 mA

- EN** N°1 analog output type
Example: TYPE = 0 / 20 mA
- DE** Art des Analogausgangs Nr. 1
Beispiel: TYPE = 0 / 20 mA
- IT** Tipo di uscita analogica n° 1
Esempio: TYPE = 0 / 20 mA
- NL** Type van de analoge uitgang n° 1
Voorbeeld: TYPE = 0 / 20 mA
- ES** Tipo de la salida analógica n° 1
Ejemplo: TYPE = 0 / 20 mA
- PT** Tipo da saída analógica n° 1
Exemplo: TYPE = 0 / 20 mA

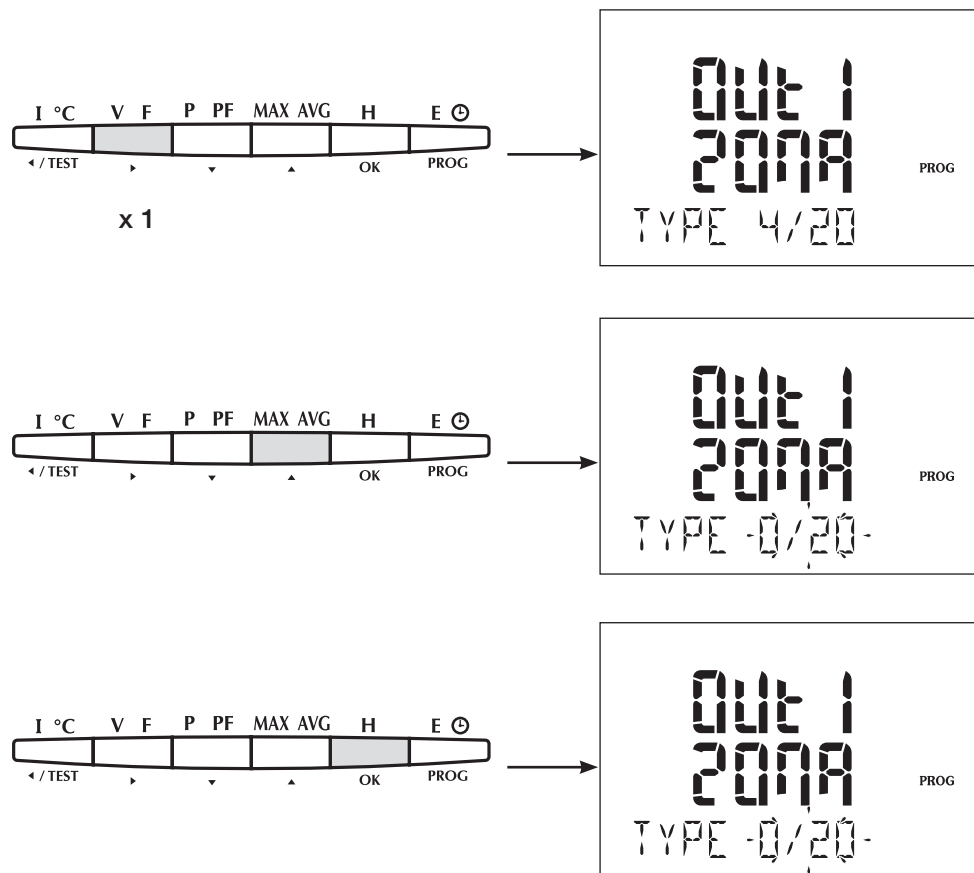

PROGRAMMATION

PROGRAMMING - KONFIGURATION - PROGRAMMAZIONE

PROGRAMMERING - PROGRAMACIÓN - PROGRAMAÇÃO

L'AFFECTATION DE LA SORTIE ANALOGIQUE N° 1 - Exemple : PAR = I2

EN N° 1 analog output allocation
Example: PAR = I2

DE Verwendung des Analogausgangs Nr. 1
Beispiel: PAR = I2

IT Assegnazione dell'uscita analogica n° 1
Esempio: PAR = I2

NL Toewijzing van de analoge uitgang n° 1
Voorbeeld: PAR = I2

ES Atribución de la salida analógica n° 1
Ejemplo: PAR = I2

PT Afectação da saída analógica n° 1
Exemplo: PAR = I2

L'AFFECTATION DE LA SORTIE ANALOGIQUE N° 1

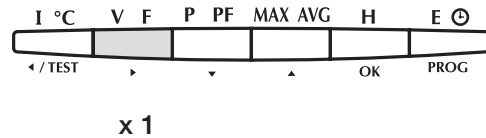

- x 1 (I2)
- x 2 (I3)
- x 3 (In)
- x 4 (U12)
- x 5 (U23)
- x 6 (U31)
- x 7 (V1)
- x 8 (V2)
- x 9 (V3)
- x 10 (ΣP)
- x 11 (ΣQ)
- x 12 (ΣS)
- x 13 (ΣPFL)
- x 14 (ΣPFC)
- x 15 (F)
- x 16 (ISYS)
- x 17 (USYS)
- x 18 (VSYs)
- x 19 (PPR)
- x 20 (QRP)
- x 21 (SPR)
- x 22 (T°C1)
- x 23 (T°C2)
- x 24 (T°C3)
- x 25 (T°C4 interne)



En cas d'affectation d'une alarme sur une entrée température PT100, si la sonde est absente, l'alarme se déclenche automatiquement.

If an alarm is allocated to a temperature input PT100 and the sensor is missing, the alarm is triggered automatically.

Im Fall einer Zuweisung eines Alarms zu einem Temperatureingangs PT100 wird der Alarm bei nicht vorhandener Sonde automatisch ausgelöst.

In caso di assegnazione di un allarme su un ingresso temperatura PT100, in assenza della sonda, l'allarme scatta automaticamente.

Als een alarm is toegewezen aan een temperatuuringang PT100, dan gaat het alarm automatisch af als de sensor ontbreekt.

En caso de asignación de una alarma a una entrada de temperatura PT100, en ausencia de sonda, la alarma se activará de forma automática.

Se não existir sonda e for afectado um alarme a uma entrada de temperatura PT100, o alarme é accionado automaticamente.

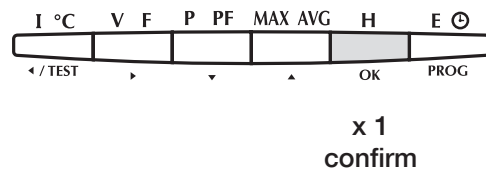

PROGRAMMATION

PROGRAMMING - KONFIGURATION - PROGRAMMAZIONE

PROGRAMMERING - PROGRAMACIÓN - PROGRAMAÇÃO

PROGRAMMATION DE LA VALEUR À 0 OU 4 mA DE LA SORTIE ANALOGIQUE N° 1

Exemple : LV = 1000 kA

Nota :

- Pour le facteur de puissance $PF = 0 = 0$ en programmation ; $PF = 0,5 = 500$ en programmation ; $PF = 1 = 1\ 000$ en programmation.
- Pour la fréquence, $F = 40\text{ Hz} = 4000$ en programmation, $F = 50\text{ Hz} = 5000$ en programmation.
- Pour ΣP , ΣQ et ΣS si le seuil bas (LV) est identique à la valeur du seuil haut (HV) la valeur sera négative (exemple : -1000 kW).

EN Programming of the n°1 analog output at 0 to 4 mA

Example: LV = 1000 kA

NB :

- For the power factor $PF = 0 = 0$ in programming ; $PF = 0,5 = 500$ in programming ; $PF = 1 = 1\ 000$ in programming.
- For the frequency $F = 40\text{ Hz} = 4000$ in programming, $F = 50\text{ Hz} = 5000$ in programming.
- For ΣP , ΣQ and ΣS if the low threshold (LV) is identical to the high threshold value (HV), the value will be negative (example : -1000 kW).

DE Programmierung des Wertes des Analogausgangs Nr. 1 bei 0 oder 4 mA

Beispiel: LV = 1000 kA

Anmerkung :

- Für den Leistungsfaktor $LF = 0 = 0$ in der Konfiguration ; $PF = 0,5 = 500$ in der Konfiguration ; $PF = 1 = 1\ 000$ in der Konfiguration.
- Für die Frequenz , $F = 40\text{ Hz} = 4000$ in der Konfiguration, $F = 50\text{ Hz} = 5000$ in der Konfiguration.
- Für ΣP , ΣQ und ΣS wenn die untere Schwelle (LV) mit der oberen Schwelle (HV) identisch ist, ist der Wert negativ (zum Beispiel : - 1000 kW).

IT Programmazione del valore a 0 oppure 4 mA dell'uscita analogica N° 1

Esempio: LV = 1000 kA

Nota :

- Per il fattore di potenza $PF = 0 = 0$ in programmazione ; $PF = 0,5 = 500$ in programmazione ; $PF = 1 = 1\ 000$ in programmazione.
- Per la frequenza , $F = 40\text{ Hz} = 4000$ in programmazione, $F = 50\text{ Hz} = 5000$ in programmazione
- Per ΣP , ΣQ e ΣS se la soglia bassa (LV) è identica al valore della soglia alta (HV), il valore sarà negativo (esempio : - 1000 kW).

NL Programmering van de waarde op 0 of 4 mA van de analoge uitgang N° 1

Voorbeeld: LV = 1000 kA

NB :

- Vermogensfactor $PF = 0 = 0$ bij het programmeren ; $PF = 0,5 = 500$ bij het programmeren ; $PF = 1 = 1\ 000$ bij het programmeren.
- Frequentie, $F = 40\text{ Hz} = 4000$ bij het programmeren, $F = 50\text{ Hz} = 5000$ Hz bij het programmeren.
- Voor ΣP , ΣQ en ΣS als de lage drempel (LV) identiek is aan de waarde van hoge drempel (HV), is de waarde negatief (voorbeeld : - 1000 kW).

ES Programación del valor a 0 o 4 mA de la salida analógica N° 1

Ejemplo: LV = 1000 kA

Nota :

- Para el factor de potencia $PF = 0 = 0$ en programación ; $PF = 0,5 = 500$ en programación ; $PF = 1 = 1\ 000$ en programación.
- Para la frecuencia, $F = 40\text{ Hz} = 4000$ en programación, $F = 50\text{ Hz} = 5000$ en programación.
- Para ΣP , ΣQ y ΣS si el valor límite mínimo (LV) es idéntico al valor límite máximo (HV), el valor será negativo (ejemplo: -1000 kW).

PT Programação do valor a 0 ou 4 mA da saída analógica N° 1

Exemplo: Lt = 1000 kA

Nota :

- Para o factor de potência $PF = 0 = 0$ em programação ; $PF = 0,5 = 500$ em programação ; $PF = 1 = 1\ 000$ em programação.
- Para a frequência, $F = 40\text{ Hz} = 4000$ em programação, $F = 50\text{ Hz} = 5000$ em programação.
- Para ΣP , ΣQ e ΣS se o limiar inferior (LV) for idéntico ao valor do limiar superior (HV), o valor será negativo (exemplo: - 1000 kW).

PROGRAMMATION DE LA VALEUR À 0 OU 4 mA DE LA SORTIE ANALOGIQUE N° 1

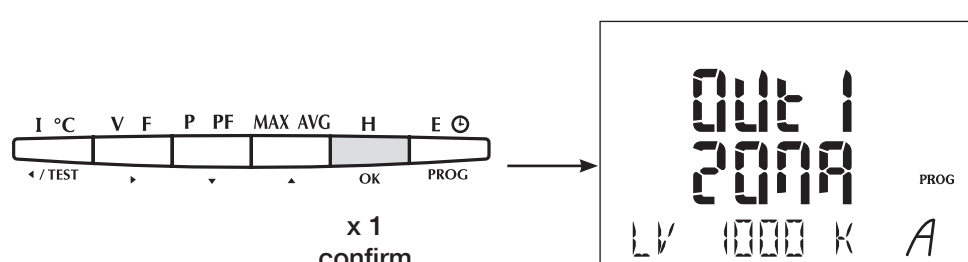
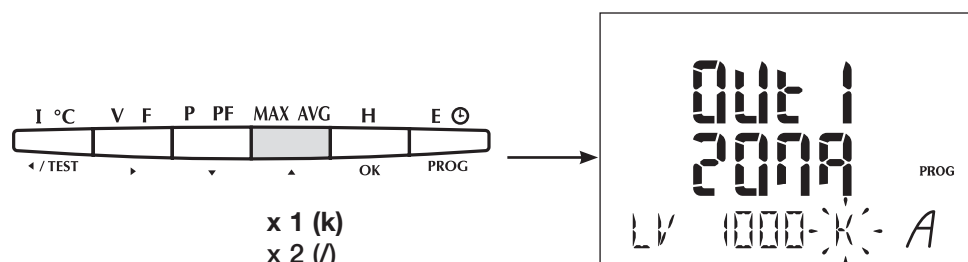
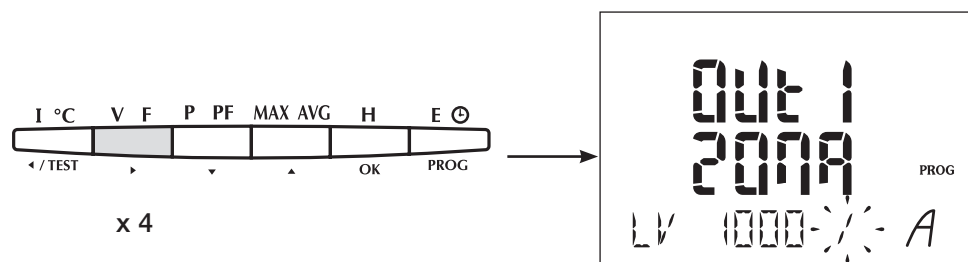
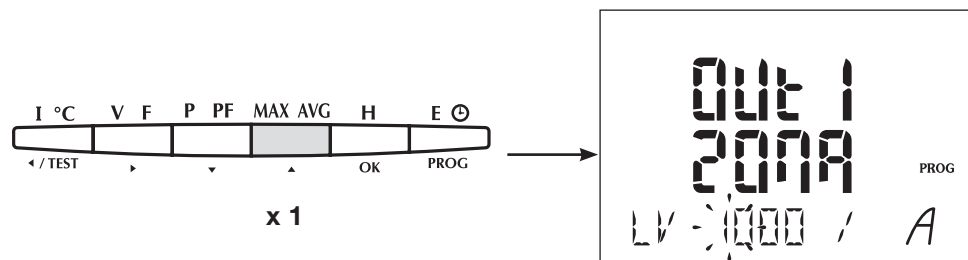
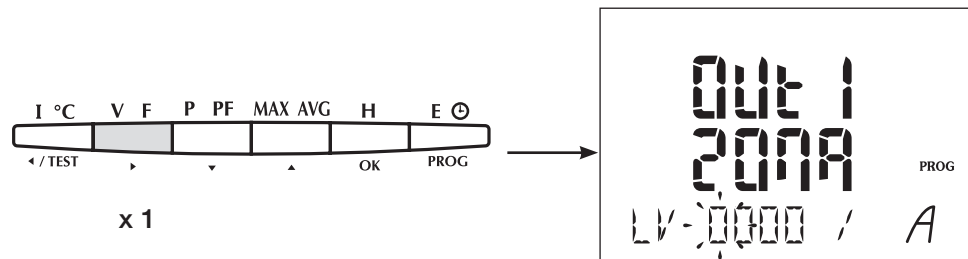

PROGRAMMATION

PROGRAMMING - KONFIGURATION - PROGRAMMAZIONE

PROGRAMMERING - PROGRAMACIÓN - PROGRAMAÇÃO

PROGRAMMATION DE LA VALEUR À 20 mA DE LA SORTIE ANALOGIQUE N° 1

Exemple : HV = 2000 kA

Nota :

- Pour le facteur de puissance $PF = 0 = 0$ en programmation ; $PF = 0,5 = 500$ en programmation ; $PF = 1 = 1\ 000$ en programmation.
- Pour la fréquence, $F = 40\ \text{Hz} = 4000$ en programmation, $F = 50\ \text{Hz} = 5000$ en programmation.

EN Programming of the n°1 analog output value at 4 mA

Example: HV = 2000 kA

NB :

- For the power factor $PF = 0 = 0$ in programming ; $PF = 0.5 = 500$ in programming ; $PF = 1 = 1\ 000$ in programming.
- For the frequency $F = 40\ \text{Hz} = 4000$ in programming, $F = 50\ \text{Hz} = 5000$ in programming.

DE Programmierung des Wertes des Analogausgangs Nr. 1 bei 20 mA

Beispiel: HV = 2000 kA

Anmerkung :

- Für den Leistungsfaktor $LF = 0 = 0 = 0$ in der Konfiguration ; $PF = 0,5 = 500$ in der Konfiguration ; $PF = 1 = 1\ 000$ in der Konfiguration.
- Für die Frequenz , $F = 40\ \text{Hz} = 4000$ in der Konfiguration, $F = 50\ \text{Hz} = 5000$ in der Konfiguration.

IT Programmazione del valore a 20 mA dell' uscita analogica N° 1

Esempio: HV = 2000 kA

Nota :

- Per il fattore di potenza $PF = 0 = 0$ in programmazione ; $PF = 0,5 = 500$ in programmazione ; $PF = 1 = 1\ 000$ in programmazione.
- Per la frequenza , $F = 40\ \text{Hz} = 4000$ in programmazione, $F = 50\ \text{Hz} = 5000$ in programmazione

NL Programmering van de waarde op 20 mA van de analoge uitgang N° 1

Voorbeeld: HV = 2000 kA

NB :

- Vermogensfactor $PF = 0 = 0$ bij het programmeren ; $PF = 0,5 = 500$ bij het programmeren ; $PF = 1 = 1\ 000$ bij het programmeren.
- Frequentie, $F = 40\ \text{Hz} = 4000$ bij het programmeren, $F = 50\ \text{Hz} = 5000\ \text{Hz}$ bij het programmeren.

ES Programación del valor a 20 mA de la salida analógica N° 1

Ejemplo: HV = 2000 kA

Nota :

- Para el factor de potencia $PF = 0 = 0$ en programación ; $PF = 0,5 = 500$ en programación ; $PF = 1 = 1\ 000$ en programación.
- Para la frecuencia, $F = 40\ \text{Hz} = 4000$ en programación, $F = 50\ \text{Hz} = 5000$ en programación.

PT Programação do valor a 20 mA da saída analógica N° 1

Exemplo: HV = 2000 kA

Nota :

- Para o factor de potência $PF = 0 = 0$ em programação ; $PF = 0,5 = 500$ em programação ; $PF = 1 = 1\ 000$ em programação.
- Para a frequência, $F = 40\ \text{Hz} = 4000$ em programação, $F = 50\ \text{Hz} = 5000$ em programação.

PROGRAMMATION DE LA VALEUR À 20 mA DE LA SORTIE ANALOGIQUE N° 1

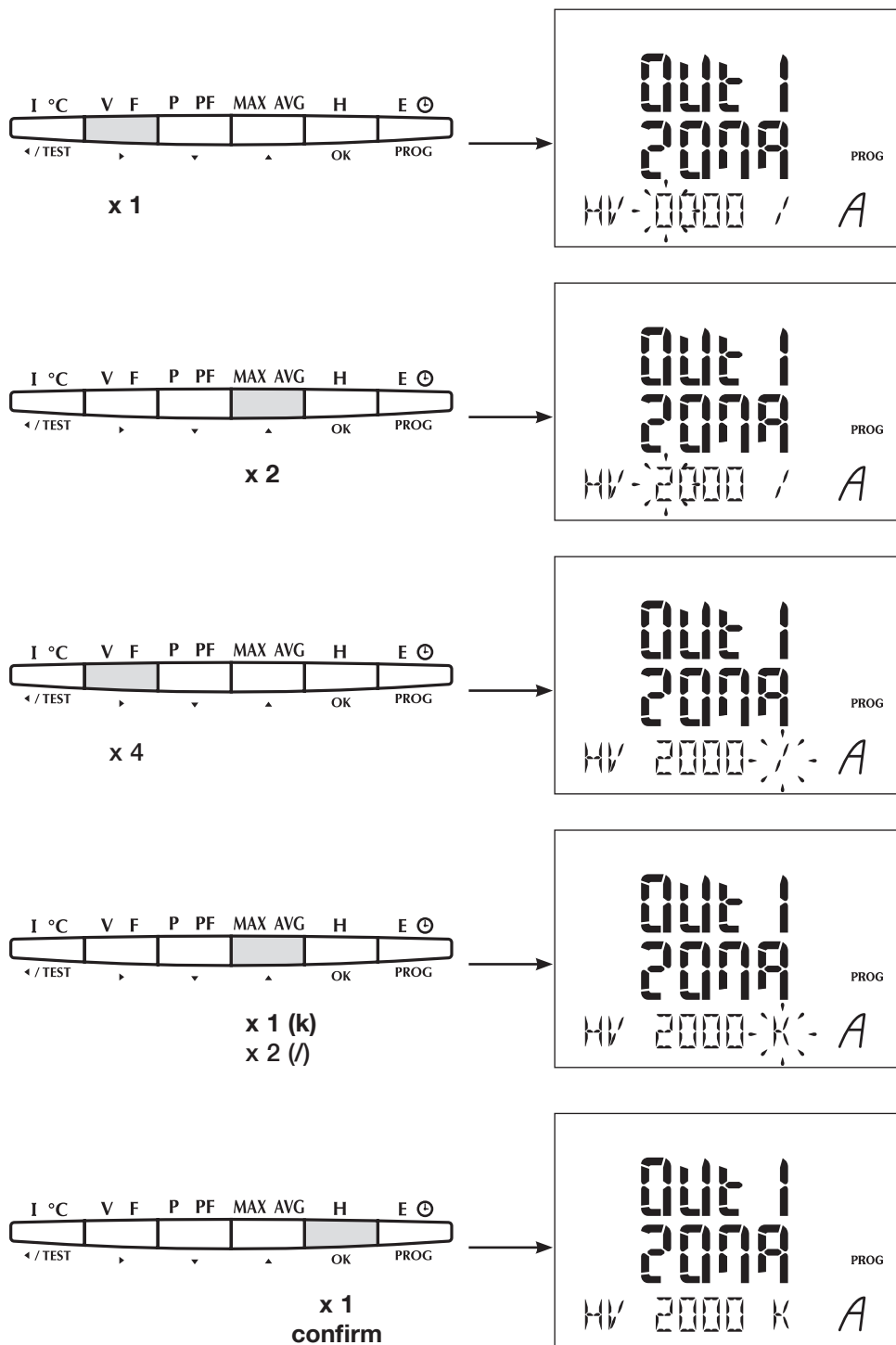

PROGRAMMATION

PROGRAMMING - KONFIGURATION - PROGRAMMAZIONE

PROGRAMMERING - PROGRAMACIÓN - PROGRAMAÇÃO

PROGRAMMATION DE LA SORTIE ANALOGIQUE N° 2, 3 ET 4

Procédez comme pour la sortie analogique numéro 1. Appuyer sur ▼ pour retourner à la programmation du réseau (Net) ou accéder à la programmation de la sortie analogique numéro 2 ou pendant 3 secondes sur **PROG** pour quitter la programmation.

EN Programming of n° 2, 3 and 4 analog output
Proceed as for number 1 analog output. Press ▼ to return to network programming (Net) or to pass to number 2 analog output programming or press for 3 seconds on **PROG** to quit programming.

DE Programmierung des Analogausgangs Nr. 2, 3 und 4
Verfahren Sie wie beim Analogausgang Nummer 1. Drücken Sie auf ▼, um zur Programmierung des Netzes (Net) zurückzukehren oder zur Programmierung des Analogausgangs Nummer 2 zu gelangen oder drücken Sie für drei Sekunden auf **PROG**, wenn Sie die Programmierung beenden möchten.

IT Programmazione dell' uscita analogica N° 2, 3 e 4
Procedere come per l'uscita analogica numero 1. Premere su ▼ per ritornare alla programmazione della rete (Net) o accedere alla programmazione dell' uscita analogica numero 2 o per 3 secondi su **PROG** per abbandonare la programmazione.

NL Programmering van de analoge uitgang N° 2, 3 en 4
Ga te werk als voor de analoge uitgang nummer 1. Druk dan op ▼ om terug te keren naar de programmering van het netwerk (Net) of toegang te krijgen tot de programmering van de analoge uitgang nummer 2 of gedurende 3 seconden op **PROG** om de programmering te verlaten.

ES Programación de la salida analógica N° 2, 3 y 4
Proceda de la misma manera que para la salida analógica número 1. Pulse ▼ para volver a la programación de la red (Net) o acceder a la programación de la salida analógica número 2 o pulse **PROG** durante 3 segundos para salir de la programación.

PT Programação da saída analógica N° 2, 3 e 4
Proceda como para a saída analógica número 1. Pressione em ▼ para voltar à programação da rede (Net) ou aceder à programação da saída analógica número 2 ou durante 3 segundos em **PROG** para sair da programação.

CARACTÉRISTIQUES TECHNIQUES

TECHNICAL CHARACTERISTICS - TECHNISCHE DATEN

CARATTERISTICHE TECNICHE - TECHNISCHE EIGENSCHAPPEN

CARACTERÍSTICAS TÉCNICAS - CARACTERÍSTICAS TÉCNICAS

FR

Sorties analogiques

Résistance de charge	0 à 600 Ohms
Temps réponse	1 s.
Isolation galvanique	2,5 kV
Précision (pleine échelle)	0,5 %

UL - CSA Approval

Normes	UL 61010-1 CSA-C22.2 No. 61010-1
Certificat	N° de dossier UL : E257746

EN

Analog outputs

Load resistance	0 to 600 Ohms
Response time	1 sec
Galvanic insulation	2.5 kV
Accuracy (full scale)	0.5 %

UL - CSA Approval

Standard	UL 61010-1 CSA-C22.2 No. 61010-1
Certificate	UL file No: E257746

DE

Analogausgänge

Ladewiderstand	0 bis 600 Ohm
Ansprechzeit	1 s.
Galvanische Trennung	2,5 kV
Genauigkeit (Vollausschlag)	0,5 %

UL - CSA Approval

Standard	UL 61010-1 CSA-C22.2 No. 61010-1
Certificate	UL file No: E257746

IT

Uscite analogiche

Resistenza di carico	0 a 600 Ohms
Tempi di risposta	1 s.
Isolamento galvanico (tensione di isolamento AC)	2,5 kV
Precisione (piena scala)	0,5 %

UL - CSA Approval

Standard	UL 61010-1 CSA-C22.2 No. 61010-1
Certificate	UL file No: E257746

CARACTÉRISTIQUES TECHNIQUES

TECHNICAL CHARACTERISTICS - TECHNISCHE DATEN

CARATTERISTICHE TECNICHE - TECHNISCHE EIGENSCHAPPEN

CARACTERÍSTICAS TÉCNICAS - CARACTERÍSTICAS TÉCNICAS

NL

Analoge uitgangen

Belastingweerstand	0 tot 600 Ohm
Responstijd	1 sec.
Galvanische isolatie	2,5 kV
Precisie (volle schaal)	0,5 %
UL - CSA Approval	
Standard	UL 61010-1
	CSA-C22.2 No. 61010-1
Certificate	UL file No: E257746

ES

Salidas analógicas

Resistencia de carga	0 a 600 Ohms
Tiempo de respuesta	1 s.
Aislamiento galvánico	2,5 kV
Precisión (escala completa)	0,5 %
UL - CSA Approval	
Norma	UL 61010-1
	CSA-C22.2 No. 61010-1
Certificado	No de expediente UL: E257746

PT

Saídas analógicas

Resistência de carga	0 a 600 Ohms
Tempo resposta	1 s.
Isolamento galvánico	2,5 kV
Precisão (escala cheia)	0,5 %
UL - CSA Approval	
Standard	UL 61010-1
	CSA-C22.2 No. 61010-1
Certificate	UL file No: E257746

LEXIQUE DES ABRÉVIATIONS

GLOSSARY OF ABBREVIATIONS - GLOSSAR DER ABKÜRZUNGEN

ELENCO DELLE ABBREVIAZIONI - LIJST VAN AFKORTINGEN

LÉXICO DE LAS ABBREVIACIONES - LÉXICO DAS ABBREVIATURAS

FR

/	Unité affichée sur l'afficheur (ex : / A = Ampères)
0/20	Commande de l'état du relais via la RS 485
4/20	Signal 4-20 mA
30 VDC	Alimentation 30 VDC pour alimenter les entrées optocoupleurs du module 2IN/2OUT
ΣP	Puissance active totale
ΣQ	Puissance réactive totale
ΣS	Puissance apparente totale
ΣPFL	Facteur de puissance inductif
ΣPFC	Facteur de puissance capacitif
F	Fréquence
I1, I2, I3	Courant I1, I2, I3
In	Courant de neutre
I SYS, U SYS, V SYS	Courant, tension composée, tension simple systèmes
K	Kilo (ex : kA = kilo ampères)
M	Méga (ex : MA = méga ampères)
Out 1 20 mA ... Out 4 20 mA	Sorties analogiques N°1 à 4
Out 1 20 mA LV ... Out 4 20 mA LV	Valeur à 0 ou 4 mA
Out 1 20 mA HV ... Out 4 20 mA HV	Valeur à 20 mA
PRP	Puissance active totale prédictive
QPR	Puissance réactive totale prédictive
SPR	Puissance apparente totale prédictive
T° C1	Température sonde externe 1
T° C2	Température sonde externe 2
T° C3	Température sonde externe 3
T° C4	Température sonde interne 4
TYPE	Affectation du type de signal 0-20 mA, 4-20 mA
U12, U23, U31	Tensions composées U12, U23, U31
V1, V2, V3	Tensions simples V1, V2, V3

EN

/	Value displayed (e.g. : A = Amps)
0/20	Relay status control via RS 485
4/20	Signal 4-20 mA
30 VDC	30 VDC feed to supply the optocoupler inputs of the 2IN/2OUT module
ΣP	Total active power
ΣQ	Total reactive power
ΣS	Total effective power
ΣPFL	Power factor (lagging)
ΣPFC	Power factor (leading)
F	Frequency
I1, I2, I3	Current I1, I2, I3
In	Neutral current
I SYS, U SYS, V SYS	Current, phase to phase voltage, phase to neutral voltage system
K	Kilo (e.g. : kA = kilo amps)
M	Mega (e.g. : MA = mega amps)
Out 1 20 mA ... Out 4 20 mA	Analogue outputs nos. 1 to 4
Out 1 20 mA LV ... Out 4 20 mA LV	Value at 0 or 4 mA
Out 1 20 mA HV ... Out 4 20 mA HV	Value at 4-20 mA
PRP	Predicted total active power
QPR	Predicted total reactive power
SPR	Predicted total apparent power
T° C1	External sensor temperature 1
T° C2	External sensor temperature 2
T° C3	External sensor temperature 3
T° C4	Internal sensor temperature 4
TYPE	Allocation of signal type 0-20 mA, 4-20 mA
U12, U23, U31	Phase-to-phase voltage U12, U23, U31
V1, V2, V3	Phase-to-neutral voltage V1, V2, V3

LEXIQUE DES ABRÉVIATIONS

GLOSSARY OF ABBREVIATIONS - GLOSSAR DER ABKÜRZUNGEN

ELENCO DELLE ABBREVIAZIONI - LIJST VAN AFKORTINGEN

LÉXICO DE LAS ABBREVIACIONES - LÉXICO DAS ABBREVIATURAS

DE

/	Angezeigte Einheit auf dem Display (z.B /A= Ampere)
0/20	Steuerung des Relaiszustandes über RS485
4/20	Signal 4-20 mA
30 VDC	Versorgung 30 VDC zur Versorgung der Optokopplereingänge des Moduls 2IN/2OUT
ΣP	Gesamte Wirkleistung
ΣQ	Gesamte Blindleistung
ΣS	Summe Scheinleistung
ΣPFL	Induktiver Leistungsfaktor
ΣPFC	Kapazitiver Leistungsfaktor
F	Frequenz
I1, I2, I3	Strom I1, I2, I3
In	Neutralleiterstrom
I SYS, U SYS, V SYS	Srom, Verkettete Spannungen, Spannungssystem
K	Kilo (z.B: kA = Kilo Ampere)
M	Mega (z.B : MA = Mega Ampere)
Out 1 20 mA ... Out 4 20 mA	Analoge Ausgänge 1 bis 4
Out 1 20 mA LV ...Out 4 20 mA LV	Wert bis 0 oder 4 mA
Out 1 20 mA HV ...Out 4 20 mA HV	Wert bis 4-20 mA
PRP	Prädiktive Gesamt-Wirkleistung
QPR	Prädiktive Gesamt-Blindleistung
SPR	Prädiktive Gesamt-Scheinleistung
T° C1	Temperatur externe Sonde 1
T° C2	Temperatur externe Sonde 2
T° C3	Temperatur externe Sonde 3
T° C4	Temperatur interne Sonde 4
TYPE	Zuweisung des Signaltyps 0-20 mA, 4-20 mA
U12, U23, U31	Verkettete Spannungen U12, U23, U31
V1, V2, V3	Spannung V1,V2,V3

IT

/	Unità di misura (es. / A = Ampère)
0/20	Comando dello stato dei relé tramite RS485
4/20	Segnale 4-20 mA
30 VCC	Alimentazione 30 VCC per alimentare le entrate ottocombinatrici del modulo 2IN/2OUT
ΣP	Potenza attiva totale
ΣQ	Potenza retroattiva totale
ΣS	Potenza apparente di sistema
ΣPFL	Fattore di potenza induttivo
ΣPFC	Fattore di potenza capacitivo
F	Frequenza
I1, I2, I3	Correnti I1, I2, I3
In	Corrente di neutro
I SYS, U SYS, V SYS	Corrente, tensione concatenate, tensione di fase sistema
K	kilo (es. / kA = kilo Ampère)
M	Mega (es. / MA = Mega Ampère)
Out 1 20 mA ... Out 4 20 mA	Uscite analogiche da 1 a 4
Out 1 20 mA LV ...Out 4 20 mA LV	Valore a 0 o 4 mA
Out 1 20 mA HV ...Out 4 20 mA HV	Valore a 20 mA
PRP	Potenza attiva totale predittiva
QPR	Potenza reattiva totale predittiva
SPR	Potenza apparente totale predittiva
T° C1	Temperatura sonda esterna 1
T° C2	Temperatura sonda esterna 1
T° C3	Temperatura sonda esterna 1
T° C4	Temperatura sonda interna 4
TYPE	Assegnazione del tipo di segnale 0-20 mA, 4-20 mA
U12, U23, U31	Tensioni concatenate U12, U23, U31
V1, V2, V3	Tensioni di fase V1, V2, V3

NL

/	Weergegeven eenheid op display (bv. / A = Ampère)
0/20	Bediening van het relais via RS 485
4/20	Signal 4-20 mA
30 VDC	Voeding 30 VDC voor het voeden van de optokoppelaar-ingangen van de module 2IN/2OUT
ΣP	Totaal actief vermogen
ΣQ	Totaal reactief vermogen
ΣS	Totaal schijnbaar vermogen
ΣPFL	Inductieve vermogensfactor
ΣPFC	Capacitatieve vermogensfactor
F	Frequentie
I1, I2, I3	Stroom I1, I2, I3
In	Stroom neuter
I SYS, U SYS, V SYS	Stroom, samengestelde spanningen, enkelvoudige spanningen systeem
K	Kilo (bv. kA = kilo-ampères)
M	Mega (bv. MA = mega-ampères)
Out 1 20 mA ... Out 4 20 mA	Analoge uitgangen n° 1 tot 4
Out 1 20 mA LV ...Out 4 20 mA LV	Waarde van 0 of 4 mA
Out 1 20 mA HV ...Out 4 20 mA HV	Waarde van 20 mA
PRP	Voorspelbaar totaal actief vermogen
QPR	Voorspelbaar totaal reactief vermogen
SPR	Voorspelbaar totaal schijnbaar vermogen
T° C1	Temperatuur externe sensor 1
T° C2	Temperatuur externe sensor 2
T° C3	Temperatuur externe sensor 3
T° C4	Temperatuur interne sensor 4
TYPE	Toewijzing van het signaaltype van 0-20 mA, 4-20 mA
U12, U23, U31	Samengestelde spanningen U12, U23, U31
V1, V2, V3	Enkelvoudige spanningen V1, V2, V3

ES

/	Unidad visualizada en el display (ej.: / A = Amperios)
0/20	Mando del estado del relé a través del Bus RS-485
4/20	Signal 4-20 mA
30 VDC	Alimentación de 30 V DC para abastecer las entradas del optoacoplador del módulo 2IN/2OUT
ΣP	Potencia activa total
ΣQ	Potencia reactiva total
ΣS	Potencia aparente total
ΣPFL	Factor de potencia inductivo
ΣPFC	Factor de potencia capacitivo
F	Frecuencia
I1, I2, I3	Intensidad I1, I2, I3
In	Intensidad del neutro
I SYS, U SYS, V SYS	Intensidad, tensiones compuestas, tensiones simple sistema
K	Kilo (ej.: kA = kiloamperios)
M	Mega (ej.: MA = megaamperios)
Out 1 A-Cd... Out 6 A-Cd	Salidas analógicas n.º 1 a 4
Out 1 20 mA LV ...Out 4 20 mA LV	Valor a 0 o 4 mA
Out 1 20 mA HV ...Out 4 20 mA HV	Valor a 20 mA
PRP	Potencia activa total predictiva
QPR	Potencia reactiva total predictiva
SPR	Potencia aparente total predictiva
T° C1	Temperatura de la sonda externa 1
T° C2	Temperatura de la sonda externa 2
T° C3	Temperatura de la sonda externa 3
T° C4	Temperatura de la sonda interna 4
TYPE	Asignación del tipo de señal 0-20 mA, 4-20 mA
U12, U23, U31	Tensiones compuestas U12, U23, U31
V1, V2, V3	Tensiones simples V1, V2, V3

LEXIQUE DES ABRÉVIATIONS

GLOSSARY OF ABBREVIATIONS - GLOSSAR DER ABKÜRZUNGEN

ELENCO DELLE ABBREVIAZIONI - LIJST VAN AFKORTINGEN

LÉXICO DE LAS ABRREVIACIONES - LÉXICO DAS ABRREVIATURAS

PT

/	Unidade visualizada no mostrador (ex. / A = Amperes)
0/20	Comando do estado do relé via RS 485
4/20	Signal 4-20 mA
30 VDC	Alimentação 30 VDC, para alimentar as entradas optoacoplador do módulo 2IN/2OUT
ΣP	Potência activa total
ΣQ	Potência reactiva total
ΣS	Potência aparente total
ΣPFL	Factor de potência indutivo
ΣPFC	Factor de potência capacitivo
F	Frequência
I1, I2, I3	Corrente I1, I2, I3
In	Corrente de neutro
I SYS, U SYS, V SYS	Corrente, tensão composta, tensões simple sistema
K	Kilo (ex. kA = quiloamperes)
M	Mega (ex. MA = megamperes)
Out 1 20 mA LV ...Out 4 20 mA LV	Valor de 0 ou 4 mA
Out 1 20 mA HV ...Out 4 20 mA HV	Valor de 20 mA
Out 1 A-Cd... Out 6 A-Cd	Saídas analógicas n° 1 a 4
PRP	Potência activa total preditiva
QPR	Potência reactiva total preditiva
SPR	Potência aparente total preditiva
T° C1	Temperatura da sonda externa 1
T° C2	Temperatura da sonda externa 2
T° C3	Temperatura da sonda externa 3
T° C4	Temperatura da sonda interna 4
TYPE	Afectação do tipo de sinal 0-20 mA, 4-20 mA
U12, U23, U31	Tensões compostas U12, U23, U31
V1, V2, V3	Tensões simples V1, V2, V3



HEAD OFFICE

SOCOMEQ GROUP

SAS SOCOMEQ capital 10633100 €
R.C.S. Strasbourg B 548 500 149
B.P. 60010 - 1, rue de Westhouse
F-67235 Benfeld Cedex
Tel. +33 3 88 57 41 41 - Fax +33 3 88 57 78 78
info.scp.isd@socomec.com

www.socomec.com



YOUR DISTRIBUTOR / PARTNER



 **socomec**
Innovative Power Solutions