

# ATyS d M

Remotely Operated  
Transfer Switching Equipment

## Installation and Commissioning

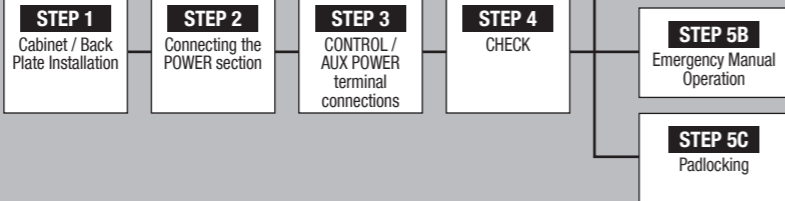

### Preliminary operations

Check the following upon delivery and after removal of the packaging:

- Packaging and contents are in good condition.
- The product reference corresponds to the order.
- Contents should include:  
Qty 1 x ATyS M  
Qty 1 x Emergency handle extension rod  
Qty 1 x Set of terminals  
Quick Start instruction sheet

### Warning

⚠ Risk of electrocution, burns or injury to persons and / or damage to equipment.

This Quick Start is intended for personnel trained in the installation and commissioning of this product. For further details refer to the product instruction manual available on the SOCOMEC website.

- This product must always be installed and commissioned by qualified and approved personnel.
- Maintenance and servicing operations should be performed by trained and authorised personnel.
- Do not handle any control or power cables connected to the product when voltage may be, or may become present on the product, directly through the mains or indirectly through external circuits.
- Always use an appropriate voltage detection device to confirm the absence of voltage.
- Ensure that no metal objects are allowed to fall in the cabinet (risk of electrical arcing).

Failure to observe good engineering practises as well as to follow these safety instructions may expose the user and others to serious injury or death.

- ⚠ Risk of damaging the device
- In case the product is dropped or damaged in any way it is recommended to replace the complete product.

### Accessories

- Bridging bars 125A or 160A.
- Control voltage transformer (400Vac -> 230Vac).
- Voltage sensing and power supply tap.
- Terminal shrouds.
- Additional aux contact block.
- Polycarbonate enclosure.
- Polycarbonate extension box.
- Dual Power Supply (DPS).
- Power Connection Terminals.
- ATS Control relay ATyS C30 + D10 or D20.
- ATS control relay ATyS C20.
- ATS control relay ATyS C40.



www.socomec.com  
www.socomec.com/en/atys-d-m  
To download, brochures, catalogues and technical manuals.

Printing informations: 1 color Black. White paper 90g/m<sup>2</sup>.  
Printing size: 420x297. Final size 210x297. This page visible first.  
A separate sheet for each language.

CORPORATE HQ CONTACT:  
SOCOMECSAS, 1-4 RUE DE WESTHOUSE, 67235 BENFELD, FRANCE



Non contractual document.  
Subject to change without notice.

## STEP 1 Installation

Caution: Ensure that the product is installed on a flat rigid surface.

### Recommended orientation

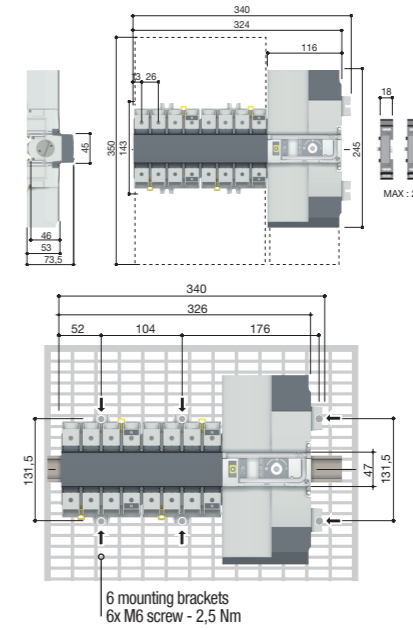
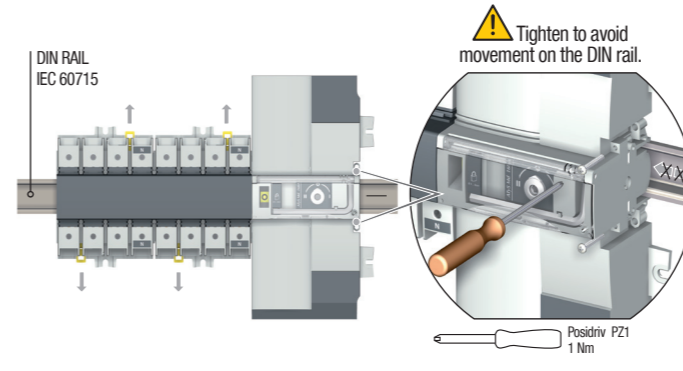
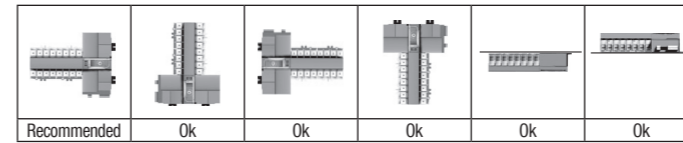

### Padlocking configuration

⚠ The ATyS M is delivered with padlocking configured to the 0 position.

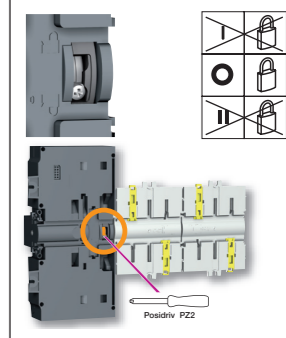

⚠ To allow padlocking in all positions (I - 0 - II), configure the ATyS M as follows before installation. (Screw is located at the back of the product).

## STEP 2 Power Terminal Connections

⚠ It is essential to tighten all used terminals, with cables and/or bridging bars, before use.



Load side bridging bar.  
125A: 1309 4006  
160A: 1309 4016

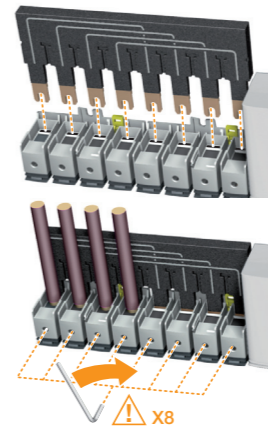
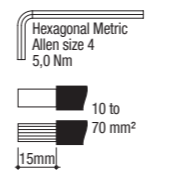

Voltage taps provide 2x ≤ 1.5mm<sup>2</sup> connections. They can be fitted in any terminals on the source supply side. Do not use on the load side when equipped with a bridging bar.

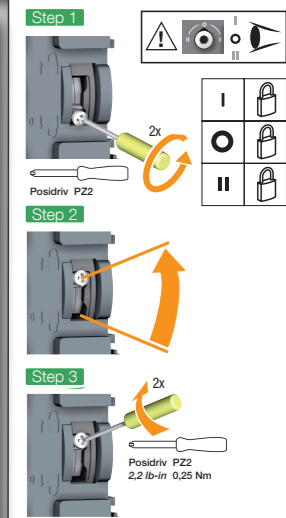
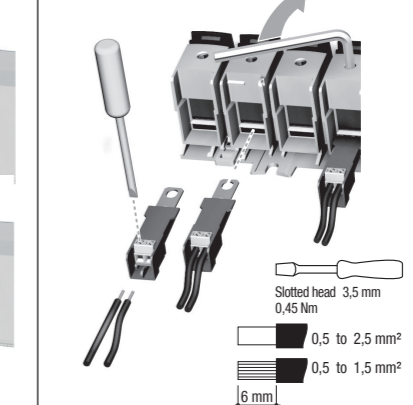

## STEP 5B Manual operation

- Open the front cover as shown to put into manual mode.
- Use the handle situated in the front panel under the cover to operate the transfer switch.
- Check the changeover switch position on the indicator before operating.

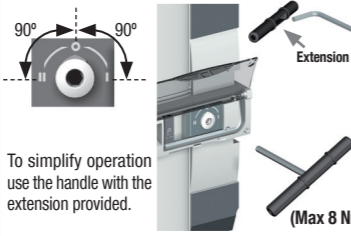

## STEP 5C Padlocking mode

- In order to padlock put the product in manual mode.
- Pull the locking mechanism and insert a padlock as shown.
- As standard padlocking in the 0 position. Configurable to I-0-II (see step 1).

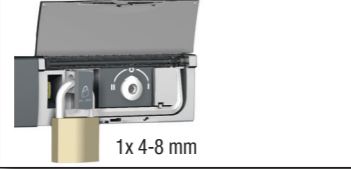

## STEP 4 Check

Whilst in manual mode, check the wiring and if ok power up the product.

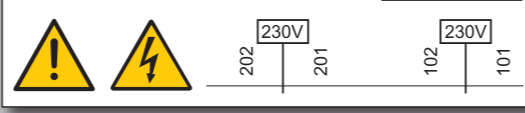

## STEP 5A Automatic operation

Close the front cover as shown to put the product into automatic mode. The product is now ready to receive order inputs based on the following logic.

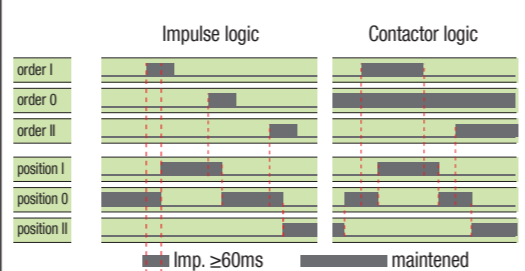

Note: Excludes position switching delays.

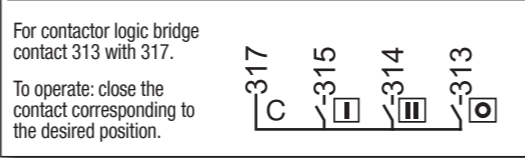

## STEP 3 CONTROL / AUX POWER Terminals and wiring

Ensure that the product is in Manual Mode (front cover open).

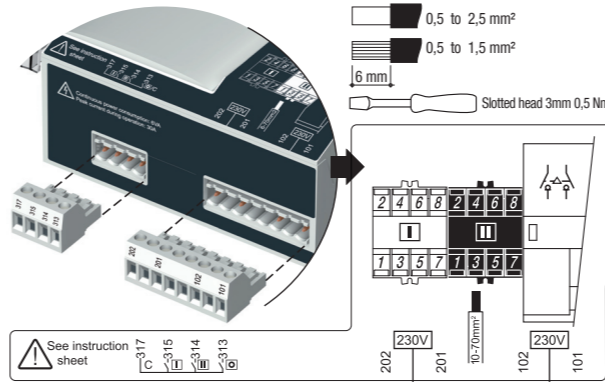

**Auxiliary contacts:** One module factory fitted (1309 0001).  
Fitting of the 2nd AC: 1309 0001 or 1309 0011  
To fit an AC, the switch must first be put in position 0. An auxiliary contact module comprises: one NO/NC changeover contact for each position (I-0-II). To install use the long screws supplied with the module.

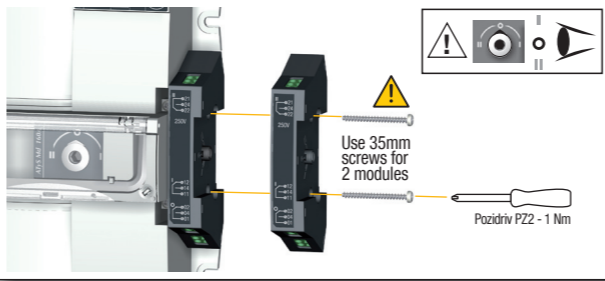

Type	Terminal no.	Description	Characteristics	Recommended connection cross-section
Inputs	101/102	Source 1 power supply	220Vac -20% (176Vac) to 240Vac +20% (288Vac) 45 to 65Hz	0,5 to 2,5 mm <sup>2</sup> (rigid)
	201/202	Source 2 power supply		
	313	Position 0 order if closed with 317. Also allows control logic selection: contactor (always closed) / impulse (close to switch)		
	314	Position II order if closed with 317		
	315	Position I order if closed with 317		
Auxiliary contacts unit.	11/12/14	Position I	Dry potential free contact 250Vac 5A AC1 24Vdc 2A	0,5 to 1,5mm <sup>2</sup> (stranded)
	21/22/24	Position II		
	01/02/04	Position 0		

⚠ Control of position I and II have priority on control of position 0.

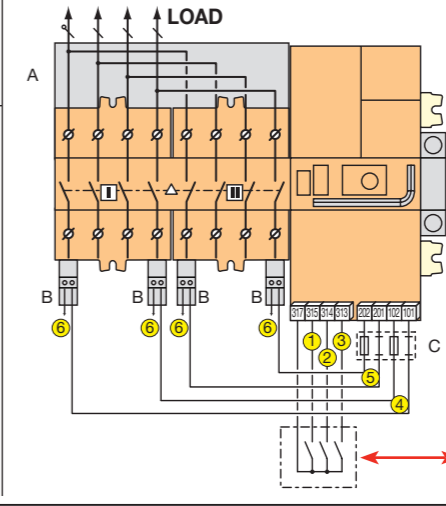

- 1: Position I order
- 2: Position II order
- 3: Position 0 order
- 4: Power supply I (230 Vac)
- 5: Power supply II (230 Vac)
- 6: Voltage tap
- 7: Auxiliary contact block - 1 NO/NC contact per position I, 0, II (1x factory fitted)

A: Bridging bar (accessory)  
B: Single-phase voltage sensing tap (accessory)  
C: F1/F2 = fuse 10 A gG

\* Remote orders from ATS controller such as ATyS C20/ C30/C40 or PLC, BMS, etc.