

# COUNTIS E21/E22

Three-phase energy meter  
Direct - 80 A Pulse

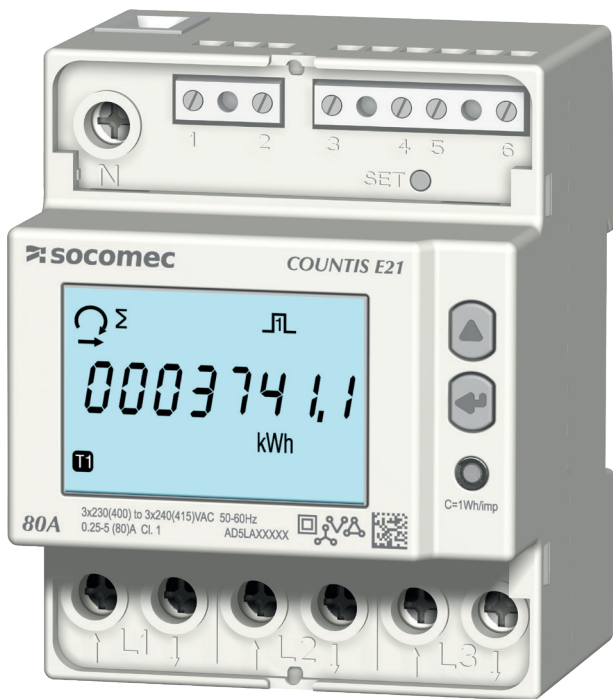

COUNTIS E21

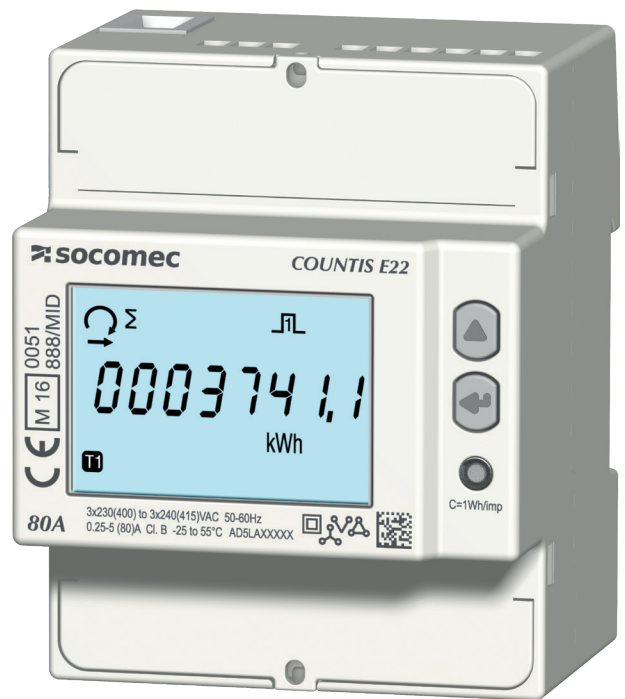

COUNTIS E22 - MID



1. DOCUMENTATION .....	3
2. HAZARDS AND WARNINGS .....	4
2.1. RISK OF ELECTROCUTION, BURNS OR EXPLOSION .....	4
2.2. RISK OF DAMAGING THE UNIT .....	4
2.3. RESPONSIBILITY .....	4
3. PRELIMINARY OPERATIONS .....	5
4. INTRODUCTION .....	6
4.1. INTRODUCING THE COUNTIS E21/E22 .....	6
4.2. FUNCTIONS .....	6
4.3. FRONT PANEL .....	6
4.4. LCD DISPLAY .....	7
4.5. DIMENSIONS .....	7
4.6. ELECTRICAL VALUES MEASURED .....	8
4.6.1. MEASUREMENTS .....	8
4.6.2. ENERGY BALANCE; DEFINITION .....	8
5. INSTALLATION .....	9
5.1. RECOMMENDATIONS AND SAFETY .....	9
5.2. DIN RAIL MOUNTED .....	9
6. CONNECTION .....	10
6.1. CONNECTING THE COUNTIS E21/E22 .....	10
6.2. CONNECTION TO THE ELECTRICAL NETWORK AND TO THE LOADS .....	11
7. MID COMPLIANCE .....	12
8. CONFIGURATION .....	13
8.1. ONSCREEN CONFIGURATION .....	13
8.1.1. DETAILED VIEW OF MENU "SETUP 1" .....	14
8.1.2. VIEW ALL OF THE MENU "SETUP 2" .....	14
8.1.3. DETAILED VIEW OF MENU "SETUP 2" .....	15
9. USE .....	16
9.1. DETAILED VIEW OF THE MENU FOR TARIFF 1, "TAR.1" .....	17
9.2. DETAILED VIEW OF THE MENU FOR TARIFF 2, "TAR.2" .....	18
9.3. DETAILED VIEW OF THE TOTAL MENU, "TOT" .....	19
9.4. DETAILED VIEW OF THE MENU SHOWING PARTIAL READINGS AND THE ENERGY BALANCE "PAR.B" .....	20
9.4.1. STARTING UP THE PARTIAL ENERGY METER .....	21
9.4.2. STOPPING THE PARTIAL ENERGY METER .....	21
9.4.3. RESETTING THE PARTIAL ENERGY METER TO ZERO .....	21
9.5. DETAILED VIEW OF THE MENU FOR REALTIME READINGS, "RT" .....	22
9.6. DETAILED VIEW OF THE MENU "INFO" .....	23
10. DIAGNOSTICS MESSAGES .....	24
10.1. MISSING PHASES .....	24
10.2. REVERSED PHASES .....	24
10.3. MALFUNCTION .....	24
11. ASSISTANCE .....	24
12. CHARACTERISTICS .....	25
13. GLOSSARY OF ABBREVIATIONS .....	27

# 1. DOCUMENTATION

All documentation on the COUNTIS E21/E22 is available on the website at the following address:

[www.socomec.com/en/countis-e2x](http://www.socomec.com/en/countis-e2x)



## 2. HAZARDS AND WARNINGS

The term "device" used in the paragraphs below refers to the COUNTIS E21/E22.

The assembly, use, servicing and maintenance of this equipment must only be carried out by trained, qualified professionals. SOCOMEC shall not be held responsible for failure to comply with the instructions in this manual.

### 2.1. Risk of electrocution, burns or explosion

- This device must only be installed and serviced by qualified personnel who have in-depth knowledge of installing, commissioning and operating the device and who have had appropriate training. He or she should have read and understood the various safety measures and warnings stated in the instructions.
- Before carrying out any work on the unit, switch off the voltage inputs.
- Always use an appropriate voltage detection device to confirm the absence of voltage.
- Replace all devices, doors and covers before turning on power to this equipment.
- Always power the device with the correct rated voltage.
- Install the unit following the recommended installation instructions and in a suitable electrical cabinet.

**Failure to take these precautions could cause death or serious injuries.**

### 2.2. Risk of damaging the unit

To ensure that the unit operates correctly, make sure that:

- The unit is correctly installed.
- There is a maximum voltage at the voltage input terminals of 288 VAC phase-neutral
- The network frequency indicated on the device is observed: 50 or 60 Hz.
- There is a maximum current of 80 A at the current input terminals (I1, I2 and I3).

**Failure to respect these precautions could cause damage to the unit.**

### 2.3. Responsibility

- Assembly, connection and use must be carried out in accordance with the installation standards currently in force.
- The unit must be installed in accordance with the rules given in this manual.
- Failure to observe the rules for installing this unit may compromise the device's intrinsic protection.
- The unit must be positioned within an installation which complies with the standards currently in force.
- Any cable which needs to be replaced may only be replaced with a cable having the correct rating.

### 3. PRELIMINARY OPERATIONS

To ensure the safety of staff and the equipment, it is vital to read and absorb the contents of these instructions thoroughly before commissioning.

Check the following points as soon as you receive the package containing the unit:

- The packaging is in good condition
- The unit has not been damaged during transportation
- The device reference number conforms to your order
- The package includes:
  - 1 device
  - 1 sealing kit (for COUNTIS E22)
  - 1 Quick Start guide

## 4. INTRODUCTION

### 4.1. Introducing the COUNTIS E21/E22

The COUNTIS E21/E22 are modular active and reactive electrical energy meters that displays consumed energy. They are designed for three-phase networks and allows a direct connection of up to 80 A.

### 4.2. Functions

- Measures and displays total and partial energy
- Dual tariff management: T1 / T2
- Electrical parameter measurements: I, U, V, f
- Power, power factor
- MID

Description	Reference
COUNTIS E21	4850 3062
COUNTIS E22	4850 3049

### 4.3. Front panel

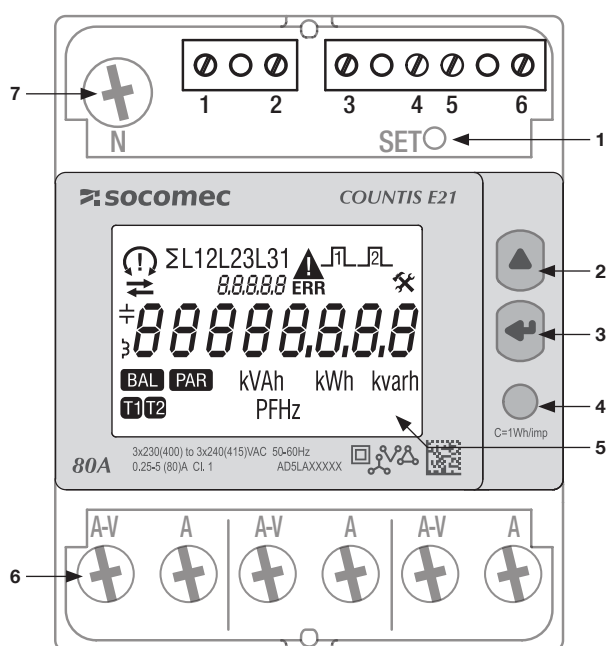

1. SET button
2. UP button
3. ENTER key
4. Metrological LED
5. LCD display
6. Three-phase network connection
7. Neutral connection

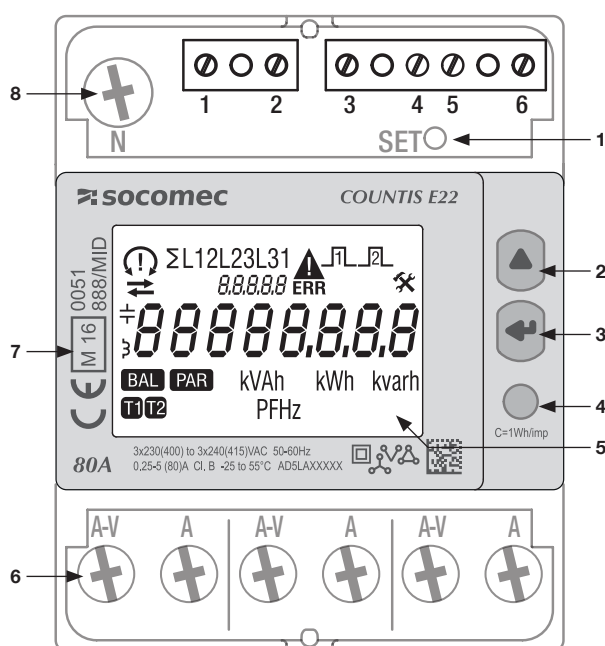

1. SET button
2. UP button
3. ENTER key
4. Metrological LED
5. LCD display
6. Three-phase network connection
7. Information relating to MID certification
8. Neutral connection

## 4.4. LCD display

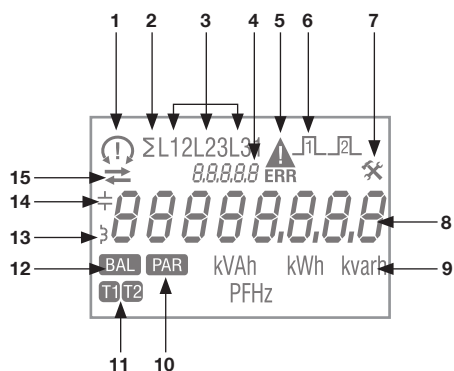

1. Phase sequences:
  - 132
  - 123
  - one or multiple phases are not detected
2. System value
3. Value by phase
4. Identification of current menu
5. Device malfunction. Replace the device
6. Active pulse output
7. Setup menu
8. Main zone
9. Measurement Unit
10. Partial meters. Flashing = partial meter has stopped
11. Tariff display
12. Energy balance
13. Inductive value
14. Capacitive value
15. Imported (→) or exported energy or power (←)

## 4.5. Dimensions

Dimensions: in/mm

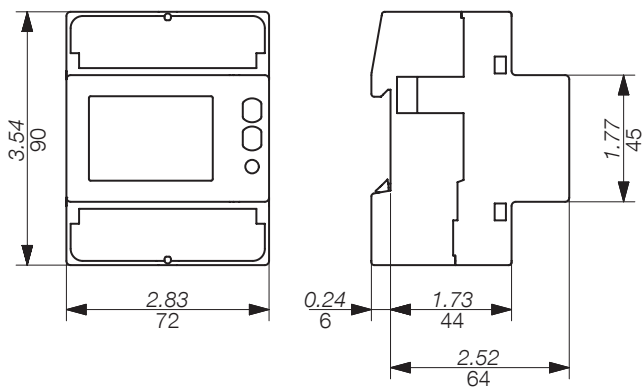

## 4.6. Electrical values measured

### 4.6.1. Measurements

Settings vary by model.

Realtime values	Symbol	Measurement Unit	LCD display
Neutral voltage	$\sum V$	V	●
Phase to phase voltage	$\sum U$		●
Current	$\sum I$	A	●
Power factor	$\sum PF$		●
Apparent power	$\sum S, S1, S2, S3$	kVA	●
Active power	$\sum P, P1, P2, P3$	kW	●
Reactive power	$\sum Q, Q1, Q2, Q3$	kVAr	●
Frequency	f	Hz	●
Phase sequence	CW / CCW		●
Direction of current	$\rightleftharpoons$		●
<b>Logged data</b>			
Total active and reactive energy	$Ea, Er$ ( $\sum$ & par phase)	kWh, kvarh	●
Total apparent energy	$Eap (\sum)$	kVAh	●
Total reactive, inductive and capacitive energy	$Er (\sum)$	kvarh	●
Total active, reactive and apparent energy for each tariff (T1/T2)	$Ea, Er (\sum)$	kWh, kvarh	●
Total reactive, inductive and capacitive energy for each tariff (T1/T2)	$Er (\sum)$	kvarh	●
Active, partial energy for each tariff (T1/T2)	$Ea (\sum)$	kWh	●
Active, reactive and apparent partial energy	$Ea, Er, Eap (\sum)$	kWh, kvarh, kVAh	●
Energy balance	$\sum$	kWh, kvarh	●
<b>Miscellaneous</b>			
Current tariff	T	1/2	●
Partial meters	BY	START/STOP	●
State of the pulse output	$\overline{\square}$	Active / Inact active	●

NOTE:  $\sum$  is the sum of the meter readings for each phase, divided by 3.

NOTE: If you have a 3-wire connection the following voltage readings are not available; phase-neutral, neutral current, phase power, power factor for each phase and power for each phase.

### 4.6.2. Energy balance; definition

	Formula
kWh	(+kWh T1) – (-kWh T1) + (+kWh T2) – (-kWh T2)
kvarh	(+kvarh T1) – (-kvarh T1) + (+kvarh T2) – (-kvarh T2)



# 5. INSTALLATION

The paragraphs below describe how to install the device.

## 5.1. Recommendations and safety

Refer to the safety instructions (section "2. Hazards and warnings", page 4)

- Keep away from electromagnetic interference generator systems,
- Avoid vibrations with accelerations greater than 1 g for frequencies lower than 60 Hz.

## 5.2. DIN rail mounted

The COUNTIS E21/E22 can be mounted on a 35-mm DIN rail (EN 60715TM35). It must be used inside electrical cabinets.

# 6. CONNECTION

## 6.1. Connecting the COUNTIS E21/E22

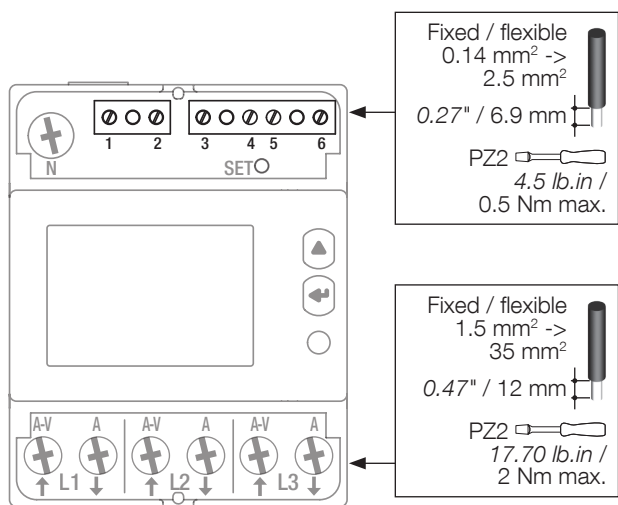

## 6.2. Connection to the electrical network and to the loads

The COUNTIS E21/E22 are intended for three-phase networks with or without neutral.

### 3 phases, 4 wires, 3 currents

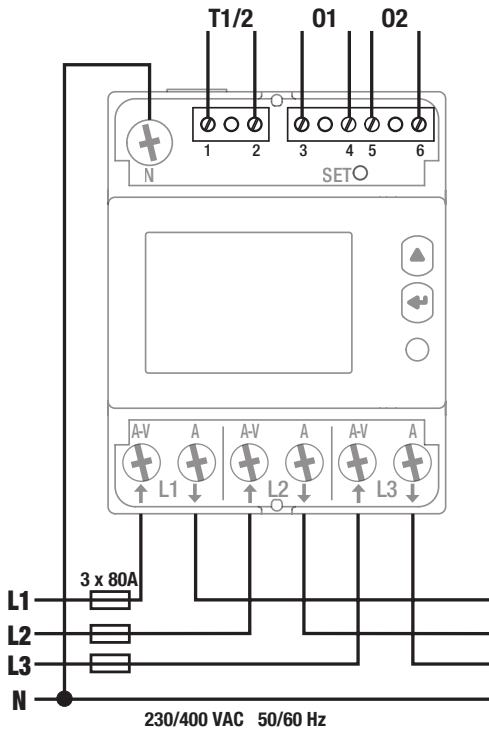

#### Price list

1-2: Switch tariffs:

0 VAC/DC -> Tariff 1

80-276 VAC/DC -> Tariff 2

#### Pulse output 1

3-4: Ea+

#### Pulse output 2

5-6: Er+

Optocoupler pulse output 250VAC/DC (100mA)

#### Mains

L1 A-V: Phase input

L1 A: Phase output

L2 A-V: Phase input

L2 A: Phase output

L3 A-V: Phase input

L3 A: Phase output

N: Neutral connection

### 3 phases, 3 wires, 3 currents

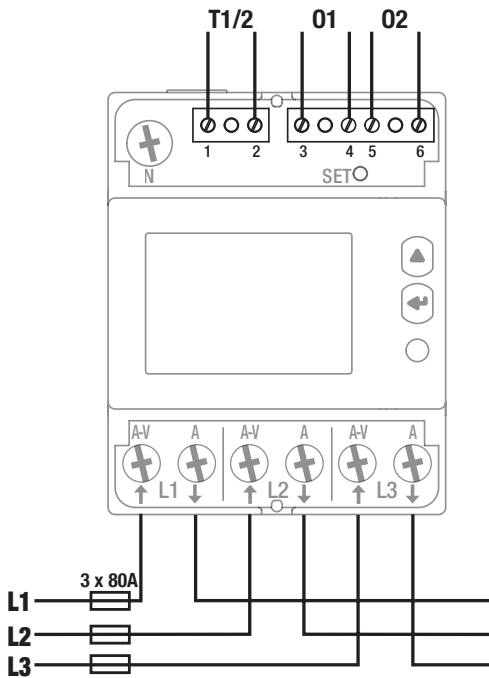

### 3 phases, 3 wires, 2 currents

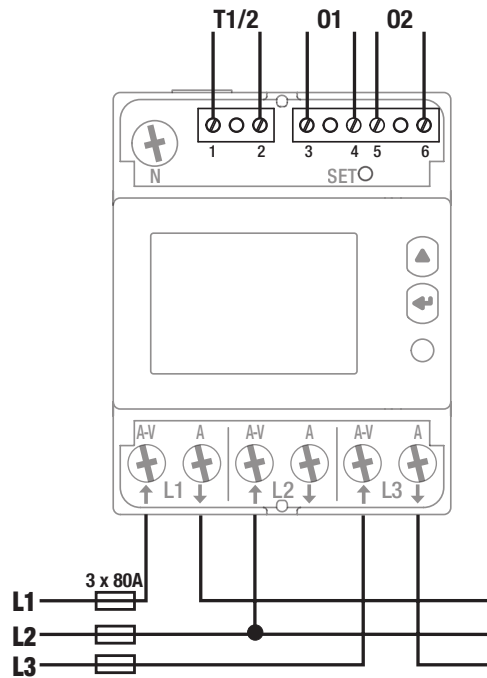

## 7. MID COMPLIANCE

The following points must be taken into consideration to ensure that the device is used in compliance with directive MID 2014/32/EU:

- **Type of network**

The COUNTIS E22 meter complies with the MID directive for connection to networks: 3P+N and 3P (see "6.2. Connection to the electrical network and to the loads", page 11)

- **Fitting terminal covers**

After connecting the device, ensure that the terminal covers are fitted properly and secured by the plastic seals provided with the device.

- **Locking the program button**

Make sure the SET program button is locked after fitting the terminal cover.

- **MID Declaration of Conformity**

The MID Declaration of Conformity is available on the website: [www.socomec.com/en/countis-e2x](http://www.socomec.com/en/countis-e2x)

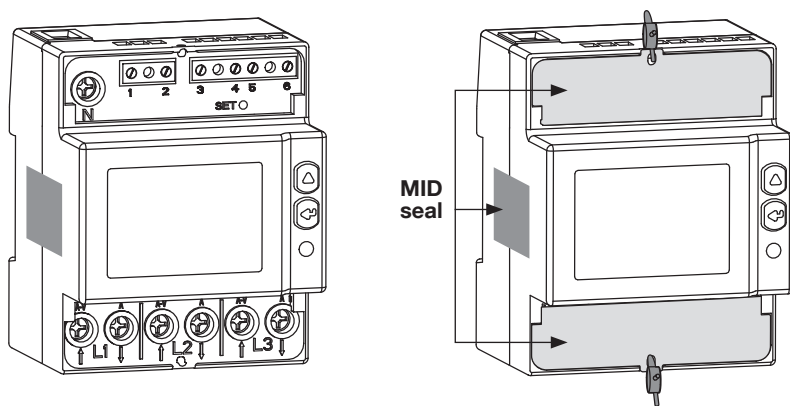











## 8. CONFIGURATION

The device can be configured directly from the COUNTIS E21/E22 screen in programming mode.

### 8.1. Onscreen configuration

From the screen, go to programming mode to reset partial energy to zero. How to browse through the programming mode is described in the following stages:

Function	Where	Buttons	Press
Switch menus	Every page with the exception of SETUP 1/2		Realtime
Switch pages within a menu	Every page within a menu		Realtime
Go to menu SETUP 2	Menu page SETUP		> 3 sec
Go to menu SETUP 1	Every page with the exception of SETUP 1	SET	> 3 sec
Exit menu SETUP 1/2	Menu SETUP 1/2		> 3 sec
Start/stop the displayed partial meter	Partial meter menu	 + 	Realtime
Reset the displayed partial meter to zero	Partial meter menu	 + 	> 3 sec
Display test	Every page with the exception of SETUP 1/2	 + 	> 10 sec

### 8.1.1. Detailed view of menu "SETUP 1"

In menu "SETUP 1" you can select the connection type.

Press SET for 3 seconds using a screwdriver to put the device into programming mode.

The default connection (Wir) is: 3.4.3 = 3 phases, 4 wires, 3 currents. Other possible connections: 3.3.3 = 3 phases, 3 wires, 3 currents or 3.3.2 = 3 phases, 3 wires, 2 currents

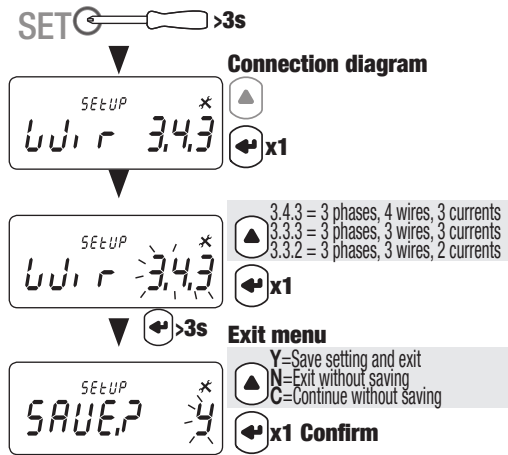

### 8.1.2. View all of the menu "SETUP 2"

In the SETUP 2 menu, press "◀" for 3 seconds to put the device into programming mode.

You can go to the different screens by pressing "▲":

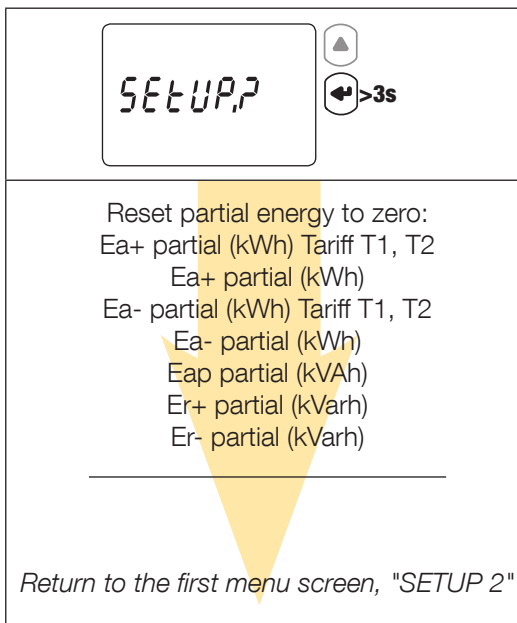

### 8.1.3. Detailed view of menu "SETUP 2"

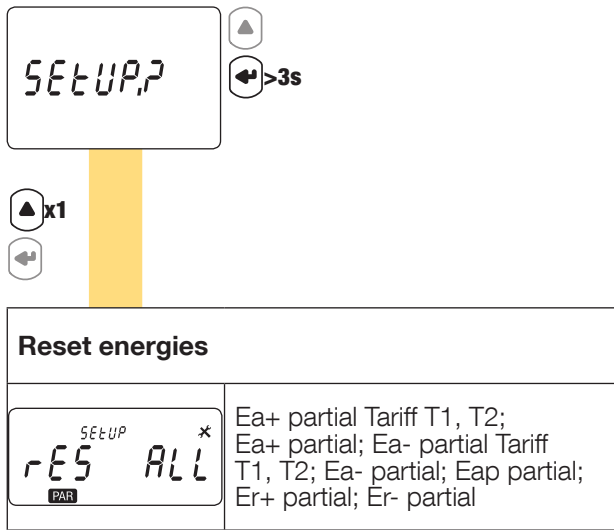

*Return to the first menu screen, "SETUP 2"*

# 9. USE

Switch menus by pressing "**◀**". Press "**▲**" to see the electrical readings or information within a menu.

The menus and related measurements are described in the table below:

<b>Tariff 1 (Tar.1)</b>	<b>Tariff 2 (Tar.2)</b>	<b>Total (tot)</b>	<b>Partial readings and energy balance (Par.b)</b>	<b>Realtime values (rt)</b>	<b>Information (inFo)</b>
Tariff 1 - Imported and exported active energy	Tariff 2 - Imported and exported active energy	Total imported and exported active energy	Partial imported active energy by tariff	Active, apparent and reactive power	Metrological firmware version
Tariff 1 - Imported and exported inductive reactive energy	Tariff 2 - Imported and exported inductive reactive energy	Total apparent energy	Partial imported active energy	Phase/phase and phase/neutral voltage	Non-metrological firmware version
Tariff 1 - Imported and exported capacitive reactive energy	Tariff 2 - Imported and exported capacitive reactive energy	Total imported and exported inductive reactive energy	Partial exported active energy by tariff	Three-phase current	Checksum of metrological firmware
Tariff 1 - Imported and exported reactive energy	Tariff 2 - Imported and exported reactive energy	Total imported and exported capacitive reactive energy	Partial exported active energy	Power factor	Checksum of non-metrological firmware
<i>Go back to first screen, menu "Tar.1"</i>	<i>Go back to first screen, menu "Tar.2"</i>	Total imported and exported reactive energy	Partial apparent energy	Frequency	Connection type
		<i>Go back to first screen, menu "tot"</i>	Partial imported and exported reactive energy	<i>Go back to first screen, menu "rt"</i>	<i>Go back to first screen, menu "info"</i>
			Active energy balance		
			Reactive energy balance		
			<i>Go back to first screen, menu "Par.b"</i>		



## 9.1. Detailed view of the menu for tariff 1, "Tar.1"

**Imported active energy, tariff 1**

$\sum_{t \in R_{r,1}}$ 000006.22 kWh	
--	--

**Exported active energy, tariff 1**

$\sum_{t \in R_{r,1}}$ 000006.22 kWh	
--	--

**Imported inductive reactive energy, tariff 1**

$\sum_{t \in R_{r,1}}$ 000006.22 kvarh	
--	--

**Exported inductive reactive energy, tariff 1**

$\sum_{t \in R_{r,1}}$ 000006.22 kvarh	
--	--

**Imported capacitive reactive energy, tariff 1**

$\sum_{t \in R_{r,1}}$ 000006.22 kvarh	
--	--

**Exported capacitive reactive energy, tariff 1**

$\sum_{t \in R_{r,1}}$ 000006.22 kvarh	
--	--

**Imported reactive energy, tariff 1**

$\sum_{t \in R_{r,1}}$ 000006.22 kvarh	
--	--

**Exported reactive energy, tariff 1**

$\sum_{t \in R_{r,1}}$ 000006.22 kvarh	
--	--

Go back to first screen, menu "Tar.1"

## 9.2. Detailed view of the menu for tariff 2, "Tar.2"

<b>Imported active energy, tariff 2</b>	
$\sum_{\text{Tar.2}}$ 000006.22 kWh	
<b>Exported active energy, tariff 2</b>	
$\sum_{\text{Tar.2}}$ 000006.22 kWh	
<b>Imported inductive reactive energy, tariff 2</b>	
$\sum_{\text{Tar.2}}$ 000006.22 kvarh	
<b>Exported inductive reactive energy, tariff 2</b>	
$\sum_{\text{Tar.2}}$ 000006.22 kvarh	
<b>Imported capacitive reactive energy, tariff 2</b>	
$\sum_{\text{Tar.2}}$ 000006.22 kvarh	
<b>Exported capacitive reactive energy, tariff 2</b>	
$\sum_{\text{Tar.2}}$ 000006.22 kvarh	
<b>Imported reactive energy, tariff 2</b>	
$\sum_{\text{Tar.2}}$ 000006.22 kvarh	

<b>Exported reactive energy, tariff 2</b>	
$\sum_{\text{Tar.2}}$ 000006.22 kvarh	

Go back to first screen, menu "Tar.2"

### 9.3. Detailed view of the total menu, "tot"

<b>Total imported active energy</b>	
 L1 $\overset{tot}{\leftarrow}$ 000008.32 kWh	L1, L2, L3, $\Sigma$

<b>Total exported active energy</b>	
 L1 $\overset{tot}{\leftarrow}$ 000008.32 kWh	L1, L2, L3, $\Sigma$

<b>Total apparent energy</b>	
 $\Sigma$ $\overset{tot}{\leftarrow}$ 000008.32 kVAh	$\Sigma$

<b>Total imported inductive reactive energy</b>	
 $\Sigma$ $\overset{tot}{\leftarrow}$ 000008.32 kvarh	$\Sigma$

<b>Total exported inductive reactive energy</b>	
 $\Sigma$ $\overset{tot}{\leftarrow}$ 000008.32 kvarh	$\Sigma$

<b>Total imported capacitive reactive energy</b>	
 $\Sigma$ $\overset{tot}{\leftarrow}$ 000008.32 kvarh	$\Sigma$

<b>Total exported capacitive reactive energy</b>	
 $\Sigma$ $\overset{tot}{\leftarrow}$ 000008.32 kvarh	$\Sigma$

<b>Total imported reactive energy</b>	
 L1 $\overset{tot}{\leftarrow}$ 000008.32 kvarh	L1, L2, L3, $\Sigma$

<b>Total exported reactive energy</b>	
 L1 $\overset{tot}{\leftarrow}$ 000008.32 kvarh	L1, L2, L3, $\Sigma$

Go back to first screen, menu "tot"

## 9.4. Detailed view of the menu showing partial readings and the energy balance "Par.b"

<b>Imported partial active energy for tariff T1</b>	
	Σ
<b>Imported partial active energy for tariff T2</b>	
	Σ
<b>Partial imported active energy</b>	
	Σ
<b>Exported partial active energy for tariff T1</b>	
	Σ
<b>Exported partial active energy for tariff T2</b>	
	Σ
<b>Partial exported active energy</b>	
	Σ
<b>Partial apparent energy</b>	
	Σ

<b>Partial imported reactive energy</b>	
	Σ
<b>Partial exported reactive energy</b>	
	Σ
<b>Active energy balance)</b>	
<b>Reactive energy balance</b>	

Go back to first screen, menu "Par.b"

### 9.4.1. Starting up the partial energy meter

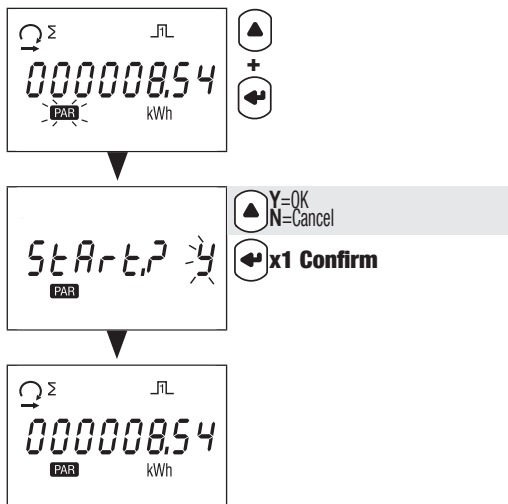

### 9.4.2. Stopping the partial energy meter

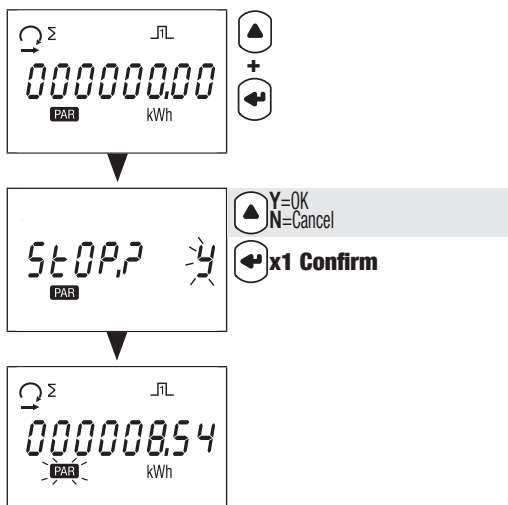

### 9.4.3. Resetting the partial energy meter to zero

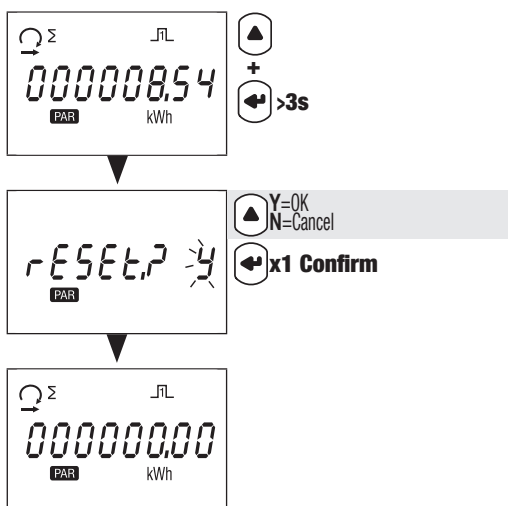

## 9.5. Detailed view of the menu for realtime readings, "rt"

Realtime active power	
$\odot$ L1 rt 1150 kW	L1, L2, L3, $\Sigma$

Realtime apparent power	
$\odot$ L1 rt 1150 kVA	L1, L2, L3, $\Sigma$

Realtime reactive power	
$\odot$ L1 rt 1150 kvar	L1, L2, L3, $\Sigma$

Realtime phase/phase voltage	
$\odot$ $\Sigma$ L12 23 31 rt 1513 V	$\Sigma$

Realtime phase/neutral voltage	
$\odot$ $\Sigma$ L1 2 3 rt 075,7 V	$\Sigma$

Realtime three-phase current	
$\odot$ $\Sigma$ rt 69,67 A	$\Sigma$

Realtime power factor	
$\odot$ $\Sigma$ rt 0,800 PF	$\Sigma$

Frequency	
$\odot$ $\Sigma$ rt 5000 Hz	

Go back to first screen, menu "rt"

## 9.6. Detailed view of the menu "info"

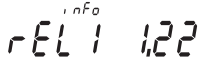
Metrological firmware version	
	

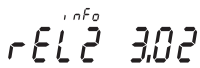
Non-metrological firmware version	
	

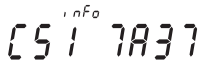
Checksum of metrological firmware	
	

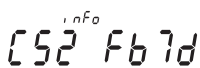
Checksum of non-metrological firmware	
	

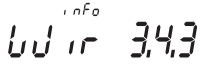
Connection type	
	3 phases, 4 wires, 3 currents 3 phases, 3 wires, 3 currents 3 phases, 3 wires, 2 currents

 Go back to first screen, menu "info"

# 10. DIAGNOSTICS MESSAGES

The following messages appear if there are connection or malfunction errors.



## 10.1. Missing phases



- If one or several phases are not detected, the exclamation point  flashes on the screen. Example: phase not detected

## 10.2. Reversed phases



- If a 123 phase sequence is detected, the  symbol appears.
- If a 132 phase sequence is detected, the  symbol appears.

## 10.3. Malfunction



- If you see this message, the meter has malfunctioned and must be replaced.

# 11. ASSISTANCE

Causes	Solutions
Device not working	Check the neutral and phase 1 cable connections.
Phases not shown onscreen	Check the connections
Phases reversed onscreen	Check the network configuration
Error message	Check the meter is working OK



## 12. CHARACTERISTICS

GENERAL FEATURES	
Compliant with	European EMC Directive No. 2014/30/EU dated 26/02/2014 LV Directive No. 2014/35/EU dated 26/02/2014 Measuring Instrument Directive MID No. 2014/32/EU dated 26/02/2014 EN50470-1/-3 IEC 62053-21/-23
Frequency	50 and 60 Hz ( $\pm 1$ Hz)
Power supply	Self-supplied
Rated dissipated power (Wmax.)	7.5VA (0.5W)
FEATURES	
Three-phase connectivity	3/4 wires 3x230/400V to 3x240/415V
Stores energy readings and settings	In FRAM memory
Identifies display of tariffs	T1 and T2
CURRENT MEASUREMENTS	
Type	Three-phase - direct 80 A
Input consumption	0.5VA max. per phase
Startup current (Ist)	20mA
Minimum current (Imin)	0.25A
Transition current (Itr)	0.5A
Reference current (Iref)	5A
Permanent overload (Imax)	80A
Intermittent overload	30 Imax for 1/2 cycle
OVERLOAD CAPACITY	
DC voltage Un	288 VAC
Realtime voltage Un (1 s)	300 VAC
DC current Imax	80 A
Realtime current Imax	30 Imax for 1/2 cycle
VOLTAGE MEASUREMENTS	
Range of measurement	230-240V $\pm 20\%$
Consumption	3.5VA max. per phase
Permanent overload	290V phase-neutral / 500V phase-phase
FREQUENCY MEASUREMENT	
Frequency measurement	45-65 Hz
ENERGY MEASUREMENT	
Active	Yes
Reactive	Yes
Total and partial reading	Yes
MID metering	Bidirectional with three-phase
Resolution	10 Wh, 10 varh
ENERGY ACCURACY	
Active energy Ea+	Class B (EN 50470-3) Class 1 (EN 62053-21)
Reactive energy Er+	Class 2 (EN 62053-23)

<b>TARIFF for Ea+</b>	
Tariff management	Yes (via input)
Number of tariffs managed	2
Tariff input	Yes
Input type	Opto-isolated
Voltage	0V --> Tariff 1 80-276 VAC-DC --> Tariff 2
<b>METROLOGICAL LED (Ea+, Ea-)</b>	
Pulse value	1000 pulses / kWh
Colour	Red
<b>PULSE OUTPUT</b>	
Type	Opto-isolated - 250 VAC/DC 100mA according to EN 62053-31
Pulse weight	100 Wh
O1	Ea+
O2	Er+
<b>DISPLAY</b>	
Type	8-digit LCD with backlight
Refresh time	1 s
Backlight activation time	10 s
Active energy: 1 display, 8-digit	000000.01 - 999999.99 kWh
Reactive energy: 1 display, 8-digit	000000.01 - 999999.99 kvarh
Apparent energy: 1 display, 8-digit	000000.01 - 999999.99 kVAh
Realtime active power: 1 display, 4-digit	00.00 - 99.99 kW
Realtime reactive power: 1 display, 4-digit	00.00 - 99.99 kvar
Realtime reactive power: 1 display, 4-digit	00.00 ... 99.99 kVA
Realtime voltage: 1 display, 4-digit	000.0 ... 999.9 V
Realtime current: 1 display, 4-digit	00.00 ... 99.99 A
Power factor: 1 display, 4-digit	0.001-1.000
Frequency: 1 display, 4-digit	45.00-65.00 Hz
<b>SAVING</b>	
Energy registers	In FRAM memory
<b>ENVIRONMENTAL CONDITIONS</b>	
Mechanical environment	M1
Electromagnetic environment	E2
Operating temperature range	-25°C to +55°C
Storage temperature	-25°C to 75°C
Humidity	≤ 80%
Installation	Internal (box/cabinet)
Vibrations	±0.075 mm
<b>HOUSING</b>	
Dimensions W x H x D (mm)	Modular - width of 4 modules (DIN 43880) 72 x 90 x 64
Mounting	On DIN rail (EN 60715)
Connection capacity, tightening torque	See chapter "6. Connection", page 10
Protection index	Front: IP51 - casing: IP20
Insulation class	Class II (EN 50470-1)
Weight	440 g

## 13. GLOSSARY OF ABBREVIATIONS

info	Menu information
rEL1	Metrological firmware version
rEL2	Non-metrological firmware version
CS1	Checksum of metrological firmware
CS2	Checksum of non-metrological firmware
tAr.1	Menu for Tariff 1
tAr.2	Menu for Tariff 2
tot	Total menu
PAr.b	Partial readings and energy balance menu
rt	Realtime values menu
SEtuP.2	Setup 2 menu
rES	Reset partial energy
ConF?	Confirm selection
Y	Save and exit
N	Exit without saving
C	Continue without saving

---

CORPORATE HQ CONTACT:  
SOCOMECSAS  
1-4 RUE DE WESTHOUSE  
67235 BENFELD, FRANCE

---

[www.socomec.com](http://www.socomec.com)

