



548032H

INOSYS LBS

PV / DC switches – 100 to 630 A

PV/DC开关 – 100至630 A

IEC: 86Pxxxxx / IEC & UL: 87Pxxxxx

Suitable for outdoor use

1	IEC	160 A / 250 A / 315 A				
	UL	100 A / 200 A / 250 A				
2	IEC	400 A / 630 A				
	UL	275 A / 325 A / 400 A 500 A / 600 A				

Switch and accessories
L'interrupteur et ses accessoires
El interruptor y sus accesorios
开关和附件

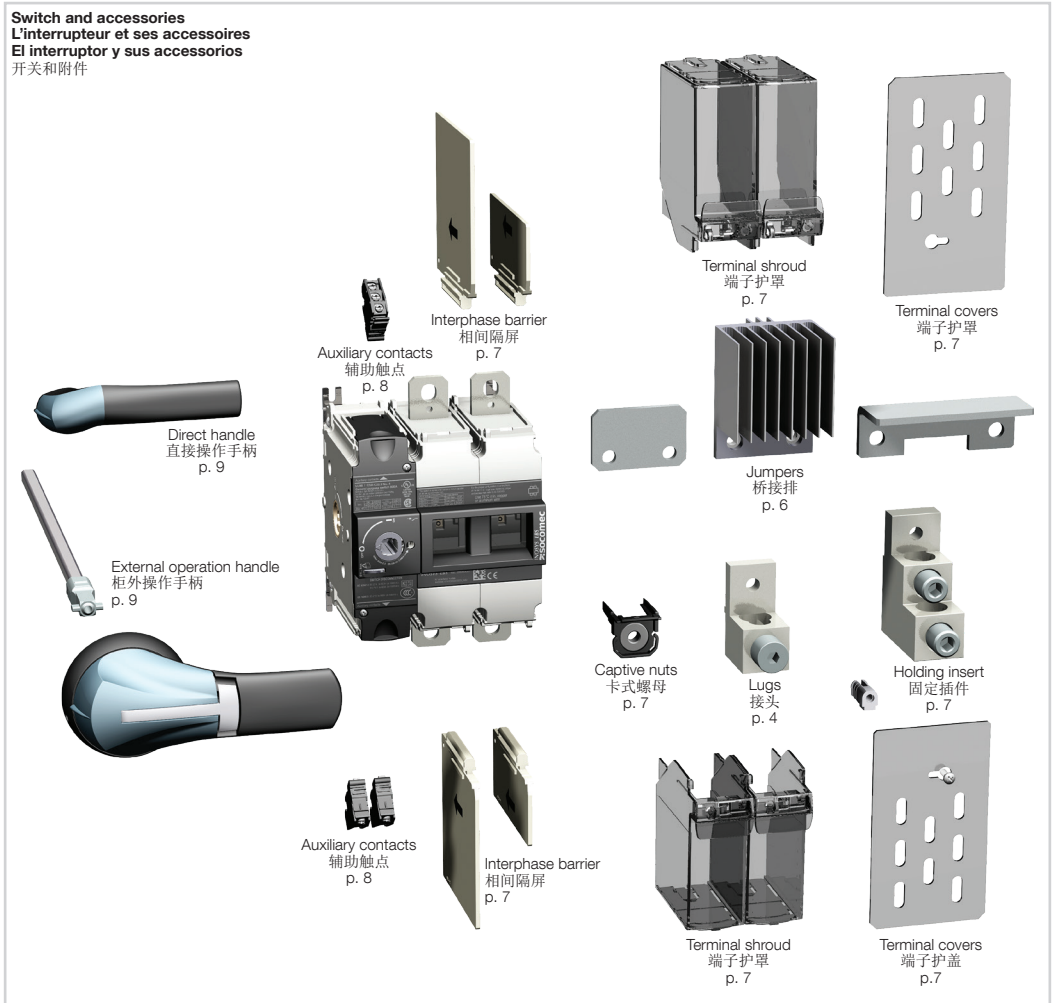

Keep the instruction sheet, it is necessary for the mounting of the accessories. Non contractual document.
Ne jetez pas cette notice : elle sera nécessaire pour le montage des accessoires. Document non contractuel.
No tirar este manual, porque es necesario para el montaje de los accesorios. Documento no contractual
保存说明书, 以备安装附件时使用。非正式文件。

Dual dimensions
Double dimensions
Dimensiones duales
双重单位制

in/mm
in/mm
in/mm
in/mm

① Interphase barrier
Ecrans entre phase
Pantalla de separación entre pletinas
相间隔屏

② Terminal screens
Ecran de protection de plages
Pantallas de protección
端子护屏

③ Terminal shroud
Caches bornes
Cubrebornes
端子护罩

		A				A1		J				J1	
		2P	3P	1+1P	2+2P	1+1P	2+2P	2P	3P	1+1P	2+2P	1+1P	2+2P
①	in	4.60	5.98	3.23	4.60	4.60	7.36	3.35	4.72	1.97	3.37	2.05	3.44
	mm	117	152	82	117	117	187	85.5	120.5	50.5	85.5	52.5	87.5
②	in	5.40	7.17	3.62	5.40	5.40	8.94	4.13	5.93	2.36	4.15	2.44	4.23
	mm	137	182	92	137	137	227	105.5	150.5	60.5	105.5	62.5	107.5

		B	B1	B2			B3	C		J2	J3	J4	J6	J7	J8	P1	P2
				IEC short	IEC long	UL		IEC	UL								
①	in	5.90	13.35	7.85	12.61	10.31	11.64	4.33	4.33	2.26	1.38	2.34	4.72	0.39	0.58	1.38	5.87
	mm	154	339	199	320	262	296	110	110	57.5	35	59.5	120	10	15	35	149
②	in	5.90	16.28	9.35	14.11	15.5	14.12	4.33	5.31	2.64	1.77	2.72	6.22	0.16	0.33	1.77	7.87
	mm	154	414	237	358	394	359	110	135	67.5	45	69.5	158	4	8	45	200

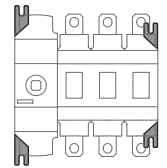
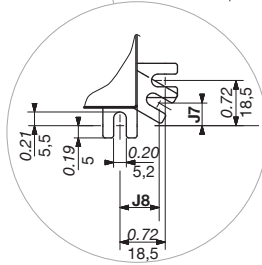
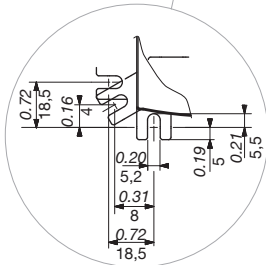
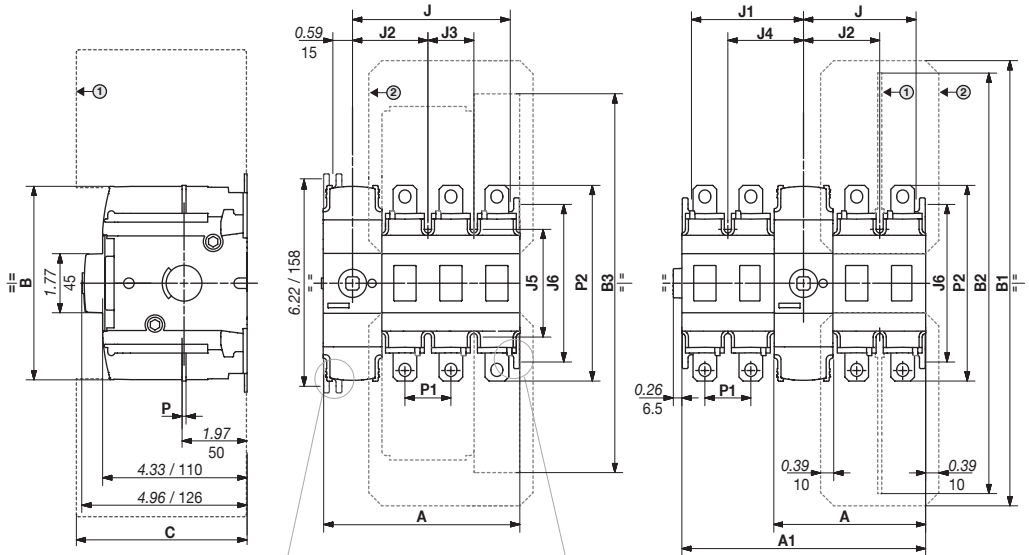

① F2 Terminals
端子

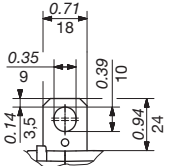

② F3 Terminals
端子

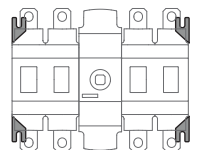
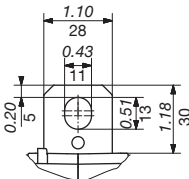

Minimum enclosure dimensions UL98B, IEC / Dimensions minimum des coffrets UL98B, IEC
Dimensiones mínimas de las cajas UL98B, IEC / 最小机壳尺寸UL98B, IEC

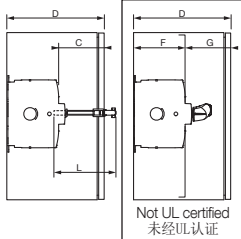
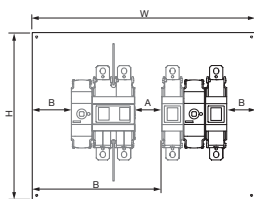

Minimum UL enclosure size / 最小机壳尺寸

		H 高 (in/mm)	W 宽 (in/mm)	D 深 (in/mm)
①	2P	24/609	16/406	6/152
	3P	24/609	16/406	6/152
	2P	36/914	24/609	8/203
②	3P	48/1219	36/914	12/305
	4P	36/914 (48/1219 for 500A)	24/609 (36/914 for 500A)	8/203 (12/304 for 500A)
	2P 600A	60/1524	36/914	20/508
	4P 600 A	60/1524	36/914	20/508

External enclosure dimension.
Dimension extérieure du coffret.
Dimensiones externas de la caja.
机壳外部尺寸

Clearance 间距	Each PV circuit up to 1500 VDC 2P				Each PV circuit up to 1000 VDC	
	①		②		①	
	in	mm	in	mm	in	mm
A min.	3.00	76,2	3.00	76,2	2.00	50,8
B min.	1.50	38,1	1.50	38,1	1.00	25,4
C min.	0.87	22	1.08	27,5	0.87	22
F min.	4.33	110	5.47	137,5	4.33	110
G min.	0	0	0,5	12,7	2,56	65

Mounting / Montage / Montaje / 安装



PZ 2
22.12 lb.in / 2,5 Nm

Mounting orientation / Sens de montage / Sentido de montaje / 安装方向

All mounting orientations are possible.
Derating may apply - please consult us.
可使用所有的安装方向。
可能需要降容 - 请联系我们。

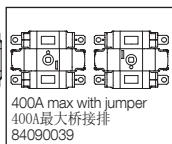
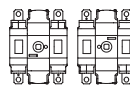

400A max with jumper
400A最大桥接排
84090039

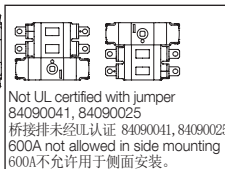
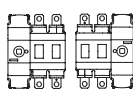

Not UL certified with jumper
84090041, 84090025
桥接排未经UL认证 84090041, 84090025
600A not allowed in side mounting
600A不允许用于侧面安装。

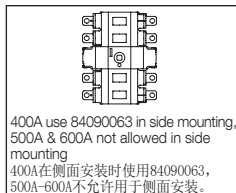

400A use 84090063 in side mounting,
500A & 600A not allowed in side mounting
400A在侧面安装时使用84090063,
500A-600A不允许用于侧面安装。

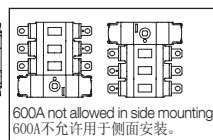
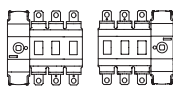

600A not allowed in side mounting
600A不允许用于侧面安装。

Connection with LUGS (UL application) & with cables or bars (IEC application)
Raccordement avec bornes à cage (application UL) et câble ou barre recommandé (application CEI)
Conexión con bornes (aplicación UL) y recomendada para cables y pletinas (aplicación IEC)
 LUGS连接 (UL应用) 以及电缆或铜排连接 (IEC应用)

Electrical clearances minimum distances (in/mm) 电气间距最小距离 (in/mm)		
	Phase/phase 相/相	Phase/ground-earth 相/接地
①	1 / 25,4	1.38 / 35
②	1 / 25,4	0.83 / 21

without accessories
不带附件

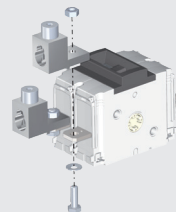

Connection with LUGS (UL application) & with cables or bars (IEC application)
Raccordement avec bornes à cage (application UL) et câble ou barre recommandé (application CEI)
Conexión con bornes (aplicación UL) y recomendada para cables y pletinas (aplicación IEC)
 LUGS连接 (UL应用) 以及电缆或铜排连接 (IEC应用)

Product Rating (A) 产品额定值 (A)	Designation Designación 名称	Ref. lugs (1) Ref. bornes à cage (1) Ref. bornes (1) 接头产品编号 (1)	Accessories (2) Accesorios (2) Accesorios (2) 附件	Quantity per reference Quantité par ref Cantidad por referencia 每个产品编号包含的数量	Openings per lug Nombre de points de connexion Numero de puntos de conexión 每个端子接头的开口	Size Section Sección (AWG) 尺寸		Pressure screw torque Couple de serrage vis de pression Par de apriete tornillo de presión 压力螺钉力矩			Bolt torque Couple de serrage boulon Par de apriete tornillo 螺栓力矩					
						min. 最小	max. 最大	lb.in	Nm	Size 尺寸	lb.in	Nm	Size 尺寸	in	mm	
① 100 - 250	 IH1 252-0-TP-STK-34-49-HEX	39542023 (2)	-	2	2	Cu:14, Al:12	10	35	4	4,5 5,1 5,6	3/16	160	18	13	1,29	32,5
		39543023 (2)	-	3												
		39544023 (2)	-	4												
② 275 - 325	 CMC LA-630R	39542040 (2)	-	2	1 2	4 1/0	600 KCMIL 250 KCMIL	550	62,1	1/2	310	35	15 17	1,79	45,7	
		39543040 (2)	-	3												
		39544040 (2)	-	4												
② 275 - 500	 CMC PV2-600	39542060 (2)	-	2	2	600 KCMIL	375	42,4	3/8	310	35	15 17	2,74	69,7		
		39543060 (2)	-	3												
		39544060 (2)	-	4												
600 (4)	 Lugs holder & BRUMALL BS350TP	39542015	39540039 (up to 3 lugs) (3)	2	2 3	6	350 KCMIL	375	42,4	3/8	310	35	15 17	2,87	72,8	
		39543015		3												



(1) Interphase barriers must be installed on the products ① or ②.
 Les écrans entre phase doivent être installés sur les produits ① ou ②.
 必须在产品上安装相间隔屏 ① 或 ②。

(2) Captive nut 84996xxx is mandatory / Ecrou captif 84996xxx est obligatoire / 卡式螺母84996xxx是强制性的

(3) Accessory is mandatory to mount the lugs on the product terminal / Accessoire obligatoire pour monter le lugs sur les bornes de produit.
 必须使用附件将凸耳安装在产品终端上。

(4) Interphase barriers must be installed also between mechanical and switching unit for 600A rating / Les écrans entrephase doivent être également installés entre la commande et le pôle de coupure pour le calibre 600A / 在機械和開關單元之間也必須安裝相间勢壘，以獲得600A的額定值。

**Recommended connection with cables or bars (IEC application) / Raccordement câble ou barre recommandé (application CEI)
Conexión recomendada para cables y pletinas (aplicación IEC) / 建议的电缆或铜排连接 (IEC应用)**

le	Nominal Cu cable section Section nominale câbles rigides Cu Sección máx. de cables de cobre rígidos 额定铜电缆横截面	Nominal Al cable section Section nominale câbles rigides Al Sección máx. de cables de Alu. rígidos 额定铝电缆横截面	Maximum busbar width Largo máx. barra 最大铜排宽度		Tightening torque Couple de serrage Par de apriete 拧紧力矩	Size		
			Non isolated bars 非隔离铜排	Isolated bars with interphase barrier 带相间隔屏的隔离铜排				
①	160 A (1)	70 mm ²	120 mm ²		≤ 20 mm	≤ 25 mm	159.31 lb.in 18 Nm	● 13
	250 A (1)	120 mm ²	185 mm ²					
	315 A (1)	185 mm ² (to use with reduced cable lug) 与缩短电缆接头一起使用)	on consultation / sur consultation / en la consulta / 在咨询					

- (1) Long interphase barriers 8499221X must be installed on the products ①.
(1) Les écrans entre phase longs 8499221X doivent être installés sur les produits ①.
(1) 必须在产品上安装相间隔屏 ①。

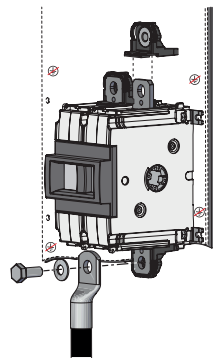
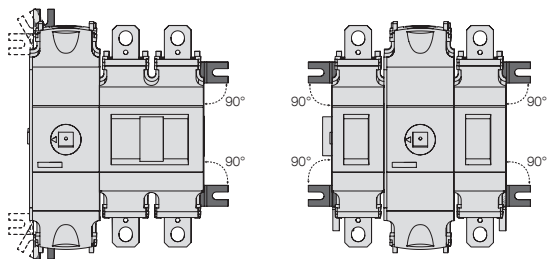

! For all F2 2P IEC 1500Vdc applications, product must be mounted according one of following configuration:
Case 1: on an insulated mounting plate
Case 2: products pads must be oriented at 90° and captive nuts (8499612X) must be used and connection shall be realized from front

对于所有F2 2P IEC 1500Vdc应用, 必须按照以下配置之一安装产品:
情况1: 在绝缘的安装板上
情况2: 产品焊盘必须定向为90°, 并且必须使用固定螺母(8499612X), 并且应从正面进行连接。



le	Nominal Cu cable section Section nominale câbles rigides Cu Sección máx. de cables de cobre rígidos 额定铜电缆横截面	Nominal Al cable section Section nominale câbles rigides Al Sección máx. de cables de Alu. rígidos 额定铝电缆横截面	Maximum busbar width Largo máx. barra 最大铜排宽度		Tightening torque Couple de serrage Par de apriete 拧紧力矩	Size		
			Non isolated bars 非隔离铜排	Isolated bars with interphase barrier 带相间隔屏的隔离铜排				
②	400 A (1)	240 mm ²	2 x 150 mm ²		≤ 25 mm	≤ 32 mm	309.77 lb.in 35 Nm	● 15 - 17
	630 A (1)	2 x 185 mm ²	2 x 300 mm ²					

- (1) Long interphase barriers 8499221X must be installed on the products ②.
(1) Les écrans entre phase longs 8499221X doivent être installés sur les produits ②.
(1) 必须在产品上安装相间隔屏 ②。

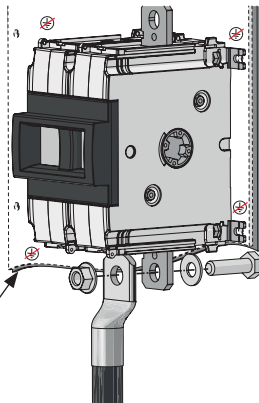

	H 高 (in/mm)	W 宽 (in/mm)
1+1P	14.17/360	6.97/177
2P	14.17/360	6.24/158.5
2+2P	14.17/360	10.51/267

! For 1500Vdc 630A PV2 applications in enclosure, with either floating or grounded metallic back plate, a H x W isolation plate must be mounted between the product and back plate. Products pads must also be oriented at 90°.

对于外壳中的1500Vdc 630A PV2应用, 带浮动或接地金属背板, 必须在产品和背板之间安装H x W隔离板。产品垫也必须定向在90°。



Mounting of jumpers - Montage des barres de pontage - Montaje de las pletinas de unión - 安装桥接排

Fig./图 A



84090016
L = 0.35in / 9mm
84090040
L = 1.38in / 35mm

one jumper only
for 100A UL
一个跳线, 仅适用
于100A UL

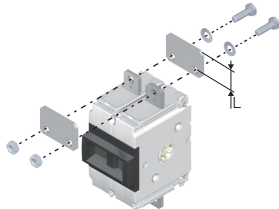

Fig./图 B



84090024
L = 1.61in / 41mm
84090039
L = 1.02in / 26mm

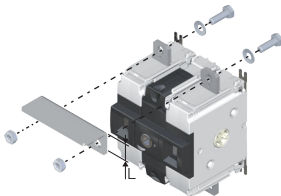
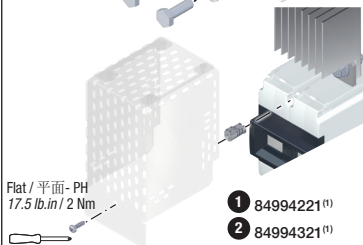

Fig./图 C



84090025
L = 1.26in / 32mm
84090031
L = 2.04in / 52mm
84090063
L = 3.38in / 86mm
84090041 (2P only)
L = 2.44in / 62mm



- 1 84994221⁽¹⁾
- 2 84994321⁽¹⁾

Grounded Network / 接地网络

		1 PV circuit Up to 1500 VDC 2P/3P 1个PV回路 可达1500 VDC 2P/3P		2 PV circuit Up to 1500 VDC 2P 2个PV回路 可达1500 VDC 2P		Tightening torque Couple de serrage Par de apriete 拧紧力矩	Size						
		Ref.	Fig.	Ref.	Fig.								
	1	UL	100A / 200A	84090016	A	-	-	159.31 lb.in 18 Nm		13			
			250A	84090016 ⁽¹⁾	A								
			84090025 ⁽²⁾ 84090031 ⁽²⁾	B									
	2	UL	275A	84090040	A	-	-	309.77 lb.in 35 Nm		15-17			
			325A										
			400A										
500A			84090041 84090063								C	-	-
600A			84090063										
	1	UL	100A / 200A	84090024	B	-	-	159.31 lb.in 18 Nm		13			
			250A										
	2	UL	275A	84090039	B	-	-	309.77 lb.in 35 Nm		15-17			
			325A										
			400A										
			500A										
	2	UL	400A	-	-	84090041 84090063	C	309.77 lb.in 35 Nm		15-17			
			500A / 600A	-	-	84090063							

⁽¹⁾For 2P. ⁽²⁾For 3P, vertical mounting orientation. ⁽³⁾For 3P, horizontal mounting orientation. ⁽¹⁾对于2P. ⁽²⁾对于3P, 垂直安装方向. ⁽³⁾对于3P, 水平安装方向.

Pole connection in series - Configuration raccordement - Conexión de los polos en serie

1 PV circuit - up to 1500 VDC / 2 PV circuit - up to 1500 VDC

串联极
1个PV回路 - 可达1500 VDC / 2个PV回路 - 可达1500 VDC

Grounded systems: in some installation standards, this configuration might not be allowed.

For ungrounded systems, see NEC 690.35 (NEC2008, NEC2011, NEC2014, NFPA70).

For multiple polarity switching (ungrounded systems or multiple circuit switching), interphase barrier must be installed before energizing.

接地系统: 在一些安装标准中, 可能不允许此配置。

对于未接地的系统, 请参阅NEC 690.35 (NEC2008, NEC2011, NEC2014, NFPA70)。

对于多极开关 (未接地系统或多回路开关), 必须在通电前安装相间隔离屏。

Grounded network
接地网络

Floating network
浮动网络

Grounded network⁽¹⁾
接地网络

Floating network
浮动网络

Grounded network
接地网络

Floating network
浮动网络

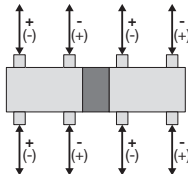
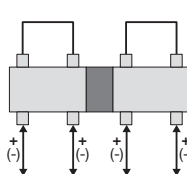
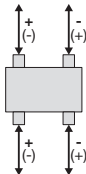
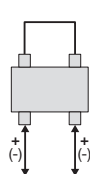
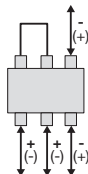
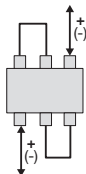

(1) 600A 1+1P UL not authorized / 600A 1 + 1P UL未授权

Voltage taps
Cosse prise tension
Kit de toma de tensión
 电压分接头

Ref./ 产品编号
1 84999012 (1)
2 84999013 (1)

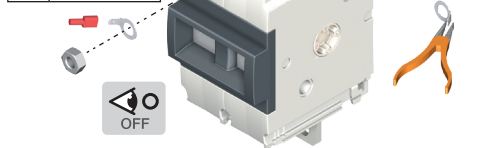

Mounting of captive nuts
Montage écrou captif
Montaje de las tuercas cautivas
 安装卡式螺母

Ref./ 产品编号
1 8499612x
2 8499613x

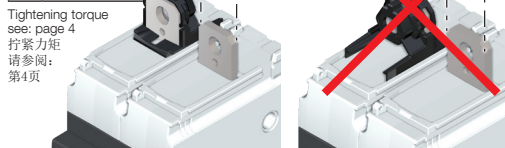

Tightening torque
 see: page 4
 拧紧力矩
 请参阅:
 第4页

Interphase barrier mounting
Montage des écrans entre phase
Montaje de pantalla de separación entre pletinas
 安装相间隔屏

For products not delivered with interphase barriers, the reference are:
 对于未提供相间隔屏的产品, 产品编号为:

Ref.
1 84992202
1 2 84992203
84992212
84992213

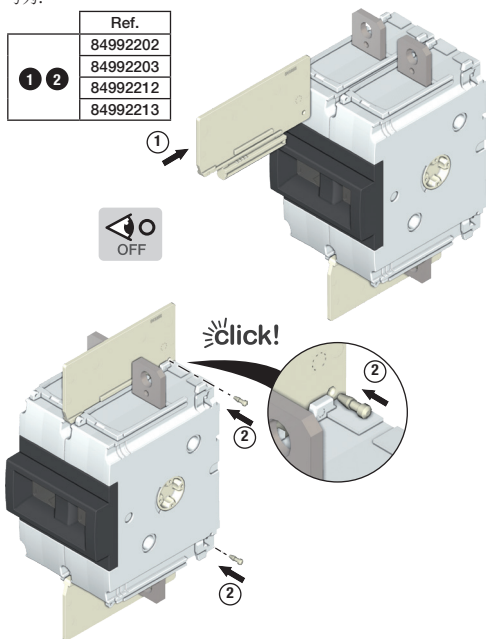

Terminal shroud mounting
Montage des caches bornes
Montaje cubrebornes
 安装端子护罩

Ref./ 产品编号
1 849942x3
849942x4
2 849943x3*
849943x4*

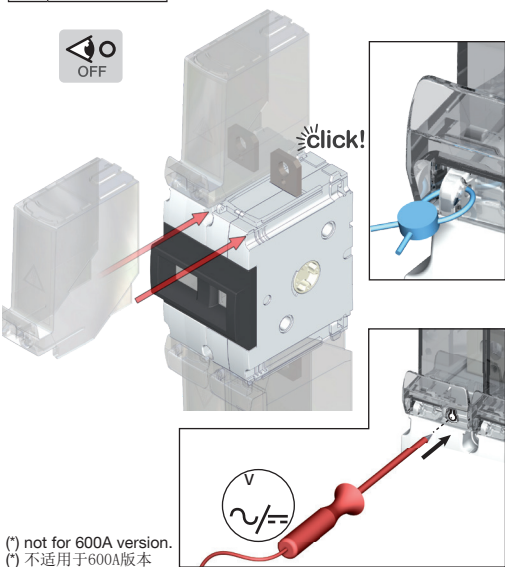

(*) not for 600A version.
 (*) 不适用于600A版本

Mounting of holding insert
Montage chevilles
Montaje de las clavijas
 安装固定插件

Ref./ 产品编号
1 8499622x
2

Note: when used, will block the interphase barrier or terminal shrouds
 注: 使用时, 将锁住相间隔屏或端子护罩。

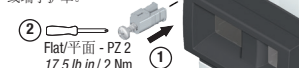

Mounting of terminal covers
Montage des capots
Montaje de las pantallas de protección
 安装端子护盖

Ref./ 产品编号
1 84993222
84993232
84993242
84993322 (1)
84993332 (1)
2 84993342 (1)
(2) 84993722
84993732
84993742

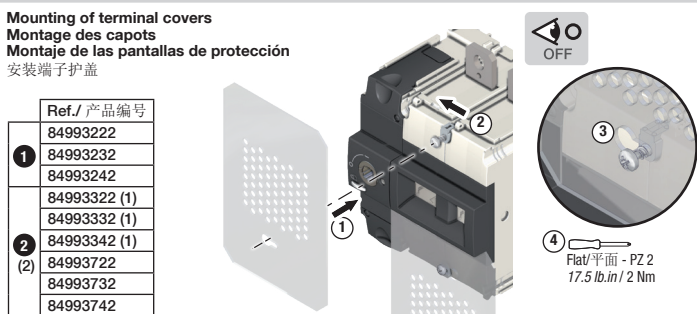

Mounting of auxiliary contacts
Montage des contacts auxiliaires
Montaje de los contactos auxiliares
 安装辅助触点

Cu	75 °C min / 最小75 °C
	AWG min 1x 20 / 2x 16 AWG max 1x 14 / 2x 14 min 1x 0,5 mm ² / 2x 1,5 mm ² max 1x 2,5 mm ² / 2x 2,5 mm ²
	0.31 in / 8mm
	Flat 5°/平面5° - PZ 2 - 7.08 lb.in / 0.8 Nm

Ref. 产品编号	Type 类型	Min. current (A) 最小电流 (A)	I _{th} (A)	Operating Current I _e (A) / 工作电流 I _e (A)				
				24 VDC DC-14	48 VDC DC-14	230 VDC AC-15	440 VDC AC-15	690 VDC AC-15
84990001	NO/NC standard	12.5 mA / 24 V	10	1	0.2	4	4	-
84990002	NO/NC low level	1 mA / 4 V	10	1	0.2	2	1	-
84990003	NC 600V	10 mA / 24 V	10	1	0.2	4	4	0.5

Line terminals of the two auxiliary contacts placed side by side must be of the same polarity. Surrounding temperature max: 75 °C (UL only)
 Les raccordements entre deux contacts auxiliaires côte à côte doivent être de la même polarité. Température de proximité max: 75 °C (UL seulement)
 Conexiones de entrada de los contactos auxiliares adyacentes deben ser de la misma polaridad. Temperatura cerca max: 75 °C (sólo UL)
 并排放置的两个辅助触点的线路端子必须是相同的极性。最大周围温度：75 °C (仅UL)。

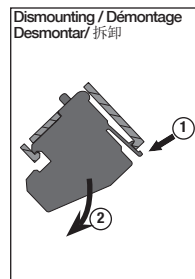
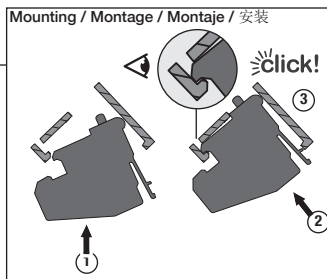
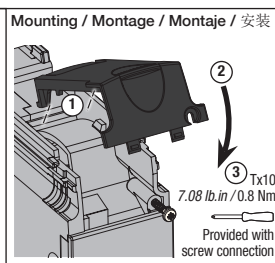
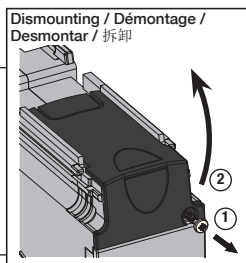
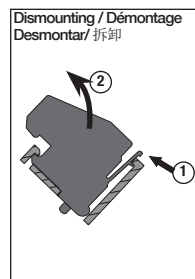
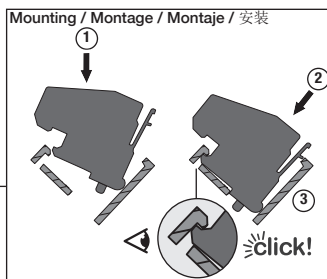
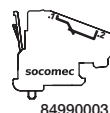
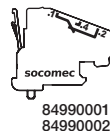
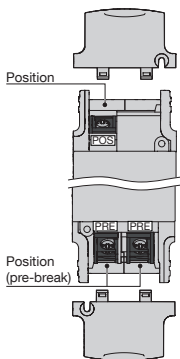

Direct handle mounting
Montage poignée direct
Montaje mando directo
 安装直接操作手柄

Ref./ 产品编号
① 849950x2 (1)
② 849950x3 (1)

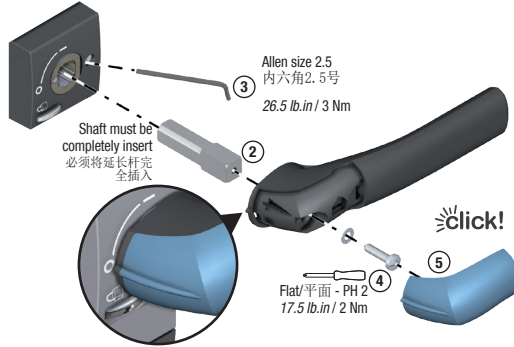
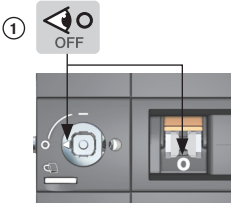

Cover dismantling
Démontage du capot
Desmontar la cubierta
 拆除护盖

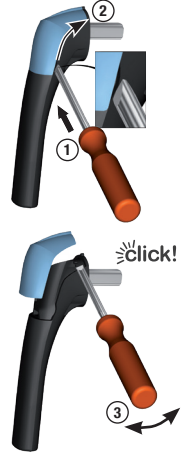

External front operation handle
Commande frontale
Mando frontal
 正面柜外操作手柄

Ref./ 产品编号
74212111 (1)
14A12111 (1)
742G2111 (2)
14AG2111
742F2111 (2)
14AF2111
① 742D2111 (2)
② 14AD2111
742E2111 (2)
14AE2111
742D2911 (2)
14AD2911 (2)
742E2911 (2)
14AE2911 (2)

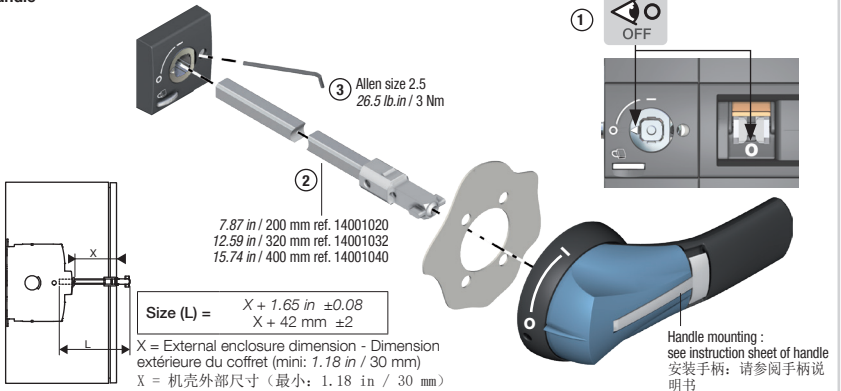

External Left Side operation
Commande latéral extérieure gauche
Mando lateral exterior izquierdo
 柜外左侧操作

Ref./ 产品编号
① 14YA2111
142J6111
14AA2111
14AJ2111
② 14YB2111
142K6111
14AB2111

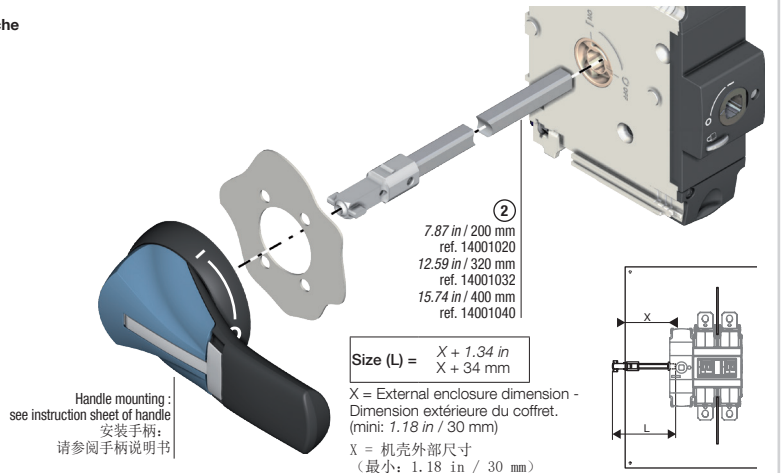
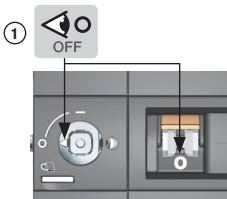

(1) Not UL certified / 未经UL认证
 (2) Not for double circuit / 不适用于双回路

Padlocking on handle or product
Cadenassage sur produit ou poignée
Enclavamiento sobre el producto o sobre el mando
将挂锁安装在手柄或产品上

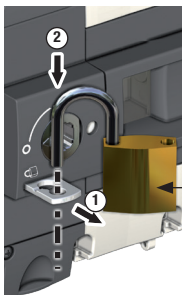

min: 1x \emptyset 0.12 in / \emptyset 3 mm
max: 2x \emptyset 0.24 in / \emptyset 6 mm
1x \emptyset 0.28 in / \emptyset 7 mm
& 1x \emptyset 0.24 in / \emptyset 6 mm

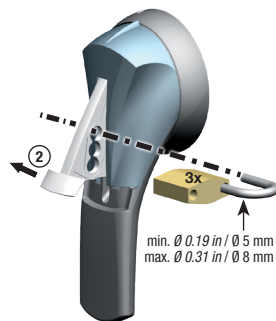

min. \emptyset 0.19 in / \emptyset 5 mm
max. \emptyset 0.31 in / \emptyset 8 mm

Verification of the product and its installation before power ON
Vérification du produit et de son installation avant mise en service
Verificación del producto y de su instalación antes de la puesta en marcha
 接通电源前，验证产品及其安装。

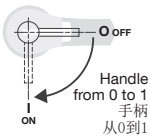
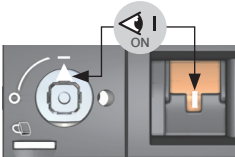
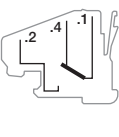
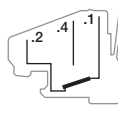
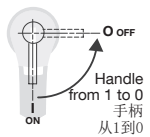
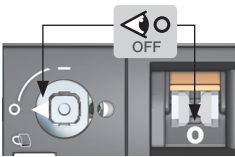
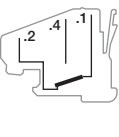
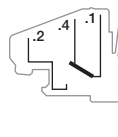
Action to be performed Action à effectuer Acción a realizar 需执行的操作	Final state of the product Etat final du produit Estado final del producto 产品的最终状态	State auxiliary contact / 辅助触点状态		Padlock feature on the product 产品上的挂锁功能
		PRE (Pre-break) PRE (预断开)	POS (contact ON position) POS (触点打开位置)	
 <p>Handle from 0 to 1 手柄从0到1</p>				NO 不能
 <p>Handle from 1 to 0 手柄从1到0</p>				Possible 可以

1) Periodic check

During installation operation or after a long period of shutdown, maintenance is recommended and consist in mechanical as described above (recommended frequency for maintenance: 1 times per year).

1) 定期检查

执行安装操作过程中或长时间关机后，建议进行维护并包括上述机械（建议维护频率：每年1次）。

1) Vérification périodique

En cours d'exploitation et selon les règles en vigueur ou après un arrêt prolongé ou un défaut, il est recommandé de faire les vérifications ci-dessus (recommandé 1 fois par an).

1) Verificación periódica

Cuando el producto está funcionando y según las reglas vigentes o después de un paro prolongado o de un defecto, se recomienda realizar las verificaciones mencionadas más arriba (1 vez cada año).

