

# NETYS PL

600-800 VA



Socomec Resources Center  
To download brochures, catalogues  
and technical manuals

## WARRANTY CERTIFICATE AND CONDITIONS

This SOCOMEC appliance is guaranteed against manufacturing and material defects for a period of 12 months from the date of purchase (local warranty conditions are applicable in addition to the general conditions). This warranty certificate should NOT be e-mailed, but kept by the customer along with proof of purchase, for use in the event of a claim being made for repairs or replacement under warranty.

The warranty period commences on the date the new product was purchased by the end user at an authorised show-room (reference details are shown on the receipt).

Return-to-base warranty is provided: components and labour for repairs supplied free of charge, any products to be replaced must be returned to SOCOMEC or authorised service centres, at the customer's own risk and expense.

The warranty is recognized within national territory. If the UPS is exported out of national territory, the warranty shall be limited to the cover of the parts used to repair the fault.

To claim service under the warranty please observe the following:

- The product must be returned in the original packing. Any damage caused during shipping in packaging other than the original will not be covered by the warranty;
- The product must be accompanied by proof of purchase such as an invoice or receipt indicating the date of purchase and product ID information (model, serial number). The sender must also attach the reference number issued to authorise the return of the product, together with a detailed description of the defect. If any of this information is missing the warranty will be invalid. The authorisation number is issued by service centres over the telephone on receiving information on the malfunction in question;
- If it is not possible to provide proof of purchase the serial number and date of manufacture will be used to calculate the probable expiry date of the warranty; this could result in a reduction of the original warranty period.

The warranty on the product does not cover damage caused by carelessness (improper use: wrong input power, explosions, excessive humidity, temperature, poor ventilation, etc.), tampering or any unauthorised repair work.

During the warranty period, SOCOMEC reserves the right to decide whether the product should be repaired, or whether to replace defective parts with new parts, or used parts that are equivalent to new parts in terms of functionality and performance.

In the case of batteries, warranty is valid only if the battery has been recharged regularly in accordance with the manufacturer's instructions. On purchasing the product it is advisable to check that the next recharge date indicated on the packaging has not expired.

### **Battery**

Batteries are treated as consumable parts and warranty only covers manufacturing defects.

Batteries must be stored in compliance with Supplier recommendations.

Warranty is valid only if the battery has been recharged regularly in accordance with the manufacturer's instructions. On purchasing the product it is advisable to check that the next recharge date indicated on the packaging has not expired.

### **Optionals**

A 12-month return-to-base warranty is provided on optionals.

### **Software products**

Software products are guaranteed for 90 days. The software is guaranteed to work as indicated in the manual accompanying the product. Hardware media or accessories (e.g. diskettes, cables, etc.) used with appliances are guaranteed free of material or manufacturing defects under normal conditions of use for a period of 12 months from the date of purchase.

SOCOMECS UPS will not be responsible for damages (including loss of income, interruption of business activity, loss of information or other financial losses, of any nature) arising from the use of the product.

These conditions are subject to Italian law. Disputes shall come under the jurisdiction of Court of Vicenza.

SOCOMECS UPS retains the full and exclusive ownership rights over this document. Only a personal right to utilize the document for the application indicated by SOCOMEC is granted to the recipient of such document. All reproduction, modification, dissemination of this document whether in part or whole and by any manner are expressly prohibited except upon Socomec's express prior written consent.

This document is not a specification. SOCOMEC reserves the right to make any changes to data without prior notice.

# CONTENTS

<b>1. SAFETY STANDARDS</b>	<b>4</b>
1.1 IMPORTANT INFORMATION.....	4
1.2 DESCRIPTION OF SYMBOLS.....	5
1.3 WARNING LABEL.....	5
<b>2. GENERAL DESCRIPTION</b>	<b>6</b>
2.1 INTRODUCTION.....	6
<b>3. REQUIREMENTS FOR INSTALLATION</b>	<b>7</b>
3.1 ELECTRICAL REQUIREMENTS.....	7
<b>4. UNPACKING AND INSTALLATION</b>	<b>7</b>
4.1 UNPACKING.....	7
4.2 REQUIREMENTS FOR INSTALLATION.....	7
<b>5. PRODUCT</b>	<b>8</b>
<b>6. CONNECTIONS</b>	<b>9</b>
<b>7. MODES OF OPERATION</b>	<b>10</b>
7.1 SWITCHING THE UPS ON.....	10
7.1.1 SWITCHING THE UPS ON WITH MAINS PRESENT.....	10
7.1.2 SWITCHING THE UPS ON WITHOUT MAINS.....	10
7.2 SWITCHING THE UPS OFF.....	10
7.3 NORMAL MODE.....	10
7.4 BATTERY MODE.....	10
7.5 OVERLOAD.....	10
<b>8. COMMUNICATION</b>	<b>11</b>
8.1 SOFTWARE OPTIONS.....	11
<b>9. SOLUTIONS TO MINOR PROBLEMS</b>	<b>12</b>
9.1 TROUBLESHOOTING FOR MINOR PROBLEMS.....	12
<b>10. BATTERY REPLACEMENT</b>	<b>12</b>
<b>11. TECHNICAL SPECIFICATIONS</b>	<b>13</b>

# 1. SAFETY STANDARDS

## 1.1 IMPORTANT INFORMATION

This manual should be kept in a safe place near the UPS, so it can be consulted by the operator at any time for information on the correct use of the unit. Read the manual carefully before connecting the unit to the ac. mains supply and downstream appliances. Before the UPS is put into commission the user should be completely familiar with its operation, the position of all the controls and the technical and functional characteristics of the unit, to ensure there will be no risk to people or the appliance itself.

This unit is designed for installation in a controlled environment (temperature-controlled, indoor area free of conductive contaminants). Avoid installing the UPS in locations where there is standing or running water or any other liquid in addition to commercial transport, nuclear facilities or any other systems where failure of the product may cause serious damage to people or property.

- Before being started-up, the unit must be connected to an earthed socket, in accordance with current safety regulations. The manufacturer declines all liability for any damage or accidents resulting from failure to observe this requirement.
- The socket should be installed near the equipment and easily accessible to remove the UPS power cable in the event of an emergency.
- Disconnect and disable the UPS completely in the event of emergency, by pressing the ON/OFF button to shut it down and disconnect the power cable from the socket.
- Do not disconnect the power cable during normal operation as this would disconnect the protective earth of the UPS and all connected loads.

	<b>CAUTION!</b> Risk of electric shock. Even after the unit is disconnected from the mains, components inside the UPS system will still be connected to the battery and live and dangerous.
---	--

- Use the UPS in accordance with the technical specifications indicated at the end of this manual.
- Avoid exposing the UPS to contact with water or any other liquids. Do not insert foreign objects into the cabinet.
- The UPS system operates with hazardous voltages. Repairs must only be carried out by qualified maintenance personnel.
- The UPS system features its own, internal current source (batteries). The UPS output sockets or output terminal block may be live even if the UPS system is not connected to the mains.

	<b>CAUTION!</b> <ul style="list-style-type: none"><li>• A battery can present a risk of electric shock and burns from high short-circuit current.</li><li>• Defective batteries can reach temperatures that exceed burn thresholds for touch surfaces.</li></ul>
---	--

	It is very dangerous to touch any part of the batteries as there is no isolation between the batteries and the mains power source.
---	--

- Never force, break or attempt to open the batteries. These batteries are sealed, maintenance-free components containing substances that are harmful to health and a source of environmental pollution. If liquid can be seen leaking from the battery, or a white powdery residue is noticeable, do not switch the UPS on.

	Danger of explosion if batteries are replaced with the wrong type.
---	--

- Used batteries must be disposed of at authorised waste disposal centres.

	<b>CAUTION</b> Users should be aware that any changes or modifications not expressly approved by Socomec could void invalidate authorisation to operate the equipment.
---	---

- If the appliance is to be scrapped contact a specialist waste disposal company which will dismantle and dispose of the various components in accordance with legislation in the country of purchase.

	<p><b>WARNING!</b> This is a category C2 UPS product. In a residential environment, this product may cause radio interference, in which case the user may be required to take additional measures.</p>
---	--

	<p><b>CAUTION IF DAMAGED. NON-SPILLABLE BATTERIES.</b> Crushed, damaged or ripped packages displaying their contents should be placed in an isolated area and inspected by a qualified person. If a package is unshippable the contents must be promptly gathered together, segregated, and the consignor or consignee contacted.</p>
---	---

	<p>All packaging material must be recycled in compliance with legislation in the country where the system is installed.</p>
---	---

 The crossed-out trash bin symbol is placed on this product to encourage users to recycle components and units whenever possible. Please be environmentally responsible and recycle this product through your recycling facility at the end of its lifetime.

 For any questions regarding the disposal of the product, contact local distributors or retailers.



## 1.2 DESCRIPTION OF SYMBOLS

Comply with all instructions and warnings on labels and plates inside and outside the equipment.

	<p><b>DANGER! HIGH VOLTAGE (BLACK/YELLOW)</b></p>
---	---

	<p><b>READ THE USER MANUAL BEFORE USING THE UNIT</b></p>
---	--

## 1.3 WARNING LABEL

902	 <p><b>CAUTION:</b></p>
<ul style="list-style-type: none"> <li>• For operation read user manual including safety warning first!</li> <li>• This unit may be opened by authorized technicians only!</li> <li>• Even when switched off there is a hazardous voltage on the battery side!</li> <li>• Lead acid battery in the inside of the enclosure!</li> <li>• Isolate uninterruptible power supply (UPS) before working on this circuit.</li> </ul>	
<p><b>WARNING: HIGH VOLTAGE INSIDE!</b></p> <p><b>WAIT 5 MINUTES BEFORE REMOVING THE COVER PROTECTIONS!</b></p>	

## 2. GENERAL DESCRIPTION

The main purpose of the UPS is to protect sensitive and critical equipment from electrical disturbances that could compromise operation. Power cuts, voltage drops, variations in voltage and frequency, lightning, electrostatic discharges and rapid over voltages are phenomena found in all office and industrial environments and which cause damage to the hardware and loss of data.

Netys PL is an Uninterruptible Power Supply designed to power computers and connected peripherals, with the exception of any other electrical device (such as household appliances, television sets, stereo systems and video recorders).

### 2.1 INTRODUCTION

The characteristic feature of these UPS systems is the constant monitoring of the power supply which, duly filtered and stabilised (on models with AVR) and if considered suitable, is used to supply consumers. In the case of a mains failure or if the mains is considered to be outside limits accepted by the load, the inverter (the heart of the UPS) is activated immediately. Drawing on the power stored in the batteries, the inverter generates a voltage that instantly takes over from the mains without any disruption to the equipment connected.

During operation under emergency conditions, the internal batteries discharge but are recharged again automatically when mains power returns.

Being hermetically sealed, the batteries do not require maintenance of any kind at any stage in their working life.

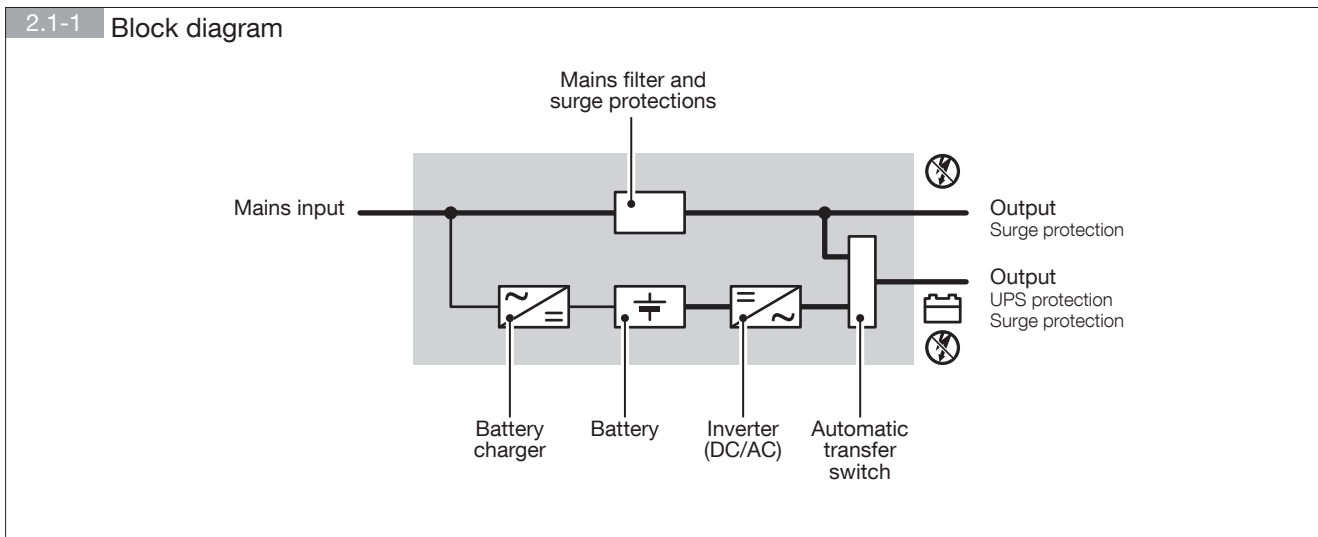

# 3. REQUIREMENTS FOR INSTALLATION

## 3.1 ELECTRICAL REQUIREMENTS

- Check the operating voltage and frequency settings are correct for the mains power supply at the installation site. Details on the technical specification page.
- When using the UPS for the first time, it is advisable to leave the battery on charge for a minimum of 8 hours.
- Only use manufacturer-supplied or recommended cables and accessories for connections to the USB serial interface.
- For better operation, please do not use the input/output power cord sets(IEC C13 to IEC C14) longer than 2m
- Do not connect appliances or devices which would overload the UPS system (e.g. laser printers) at the UPS output sockets.

# 4. UNPACKING AND INSTALLATION

## 4.1 UNPACKING

Remove the UPS and all accessories provided (cables, etc) from the packing case.

It is always advisable to keep the original packaging which has been specially designed for safe transport, in case the unit has to be moved again.

## 4.2 REQUIREMENTS FOR INSTALLATION



Make sure you have read and understood chapter 1 - Safety Standards before proceeding

- Netys PL has been designed for indoor use.
- Place the UPS on a flat, stable surface, in a ventilated environment away from heat sources and exposure to direct sunlight.
- Keep ambient temperature between 0 °C and 40 °C and humidity less than 90% (non-condensing); the best temperature to guarantee longest battery lifetime is 15-25 °C.
- Condensation may occur if the UPS system is moved directly from a cold to a warm environment. The UPS system must be completely dry before being installed. Please allow at least two hours for the UPS system to become acclimatised to the environment.
- Ensure that the environment where the UPS will be installed is not dusty.
- Do not place the UPS or any other heavy object on the cables.
- A space of at least 25 cm must be left at the back for adequate ventilation (see figure 3.2-1).

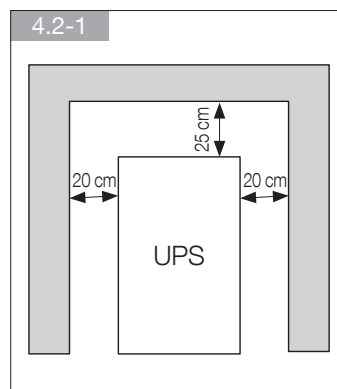

# 5. PRODUCT

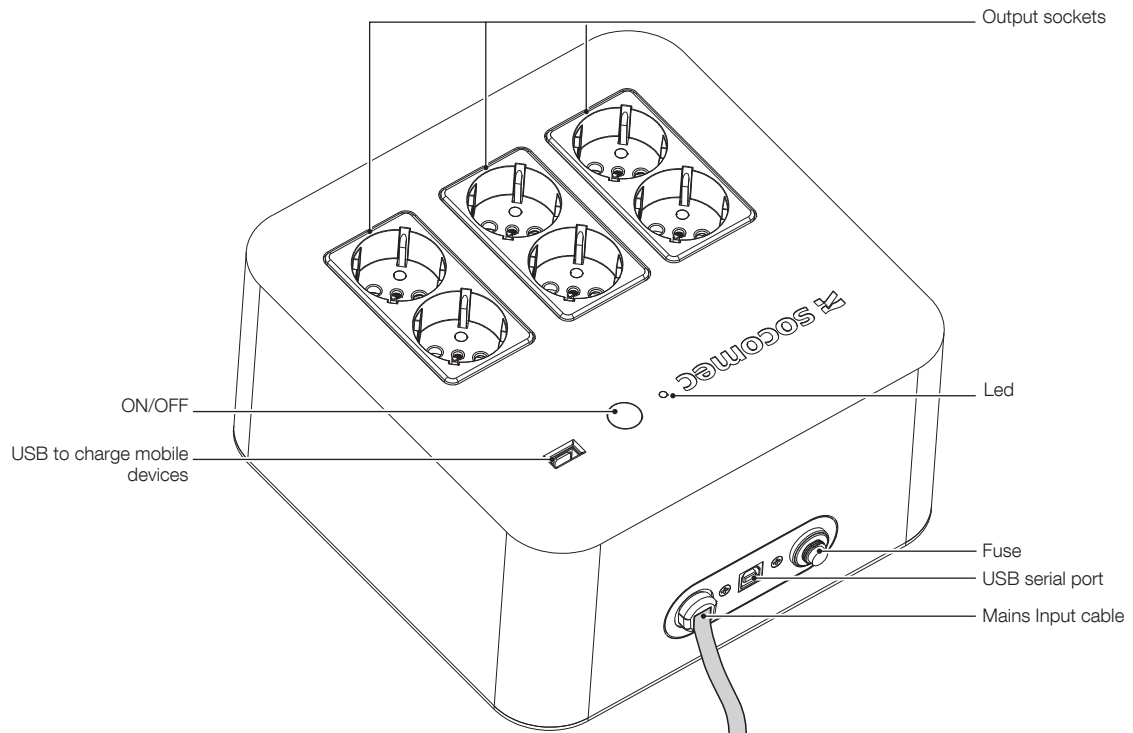



## 6. CONNECTIONS



Cables with an appropriate cross-section and which are compliant with safety standards in force should be used for connection to the mains and connection of the loads.

**OUT 230 V~**  
4 load connection socket for  
UPS and surge protection.

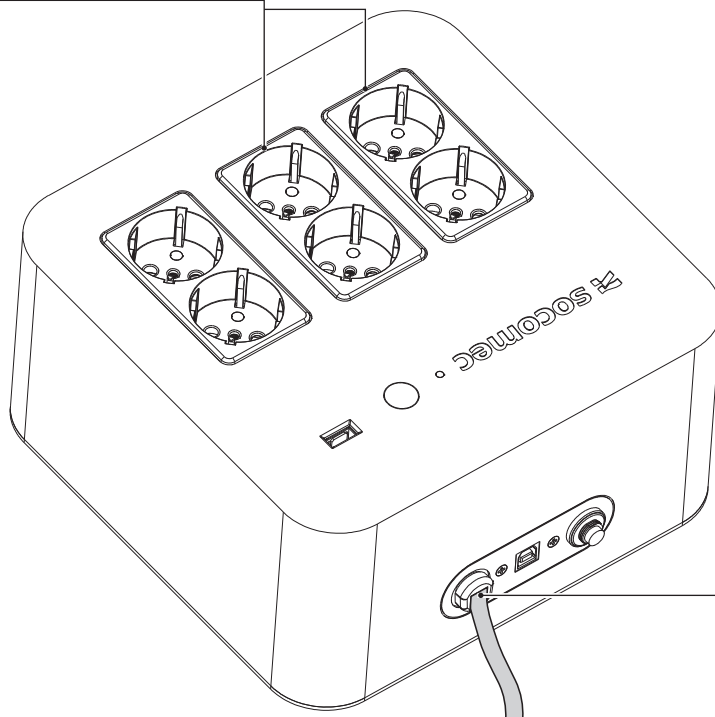

**IN 230 V~**  
Connect the UPS  
power cord to the  
mains power supply.

**OUT 230 V~**  
2 load connection sockets for  
surge protection.

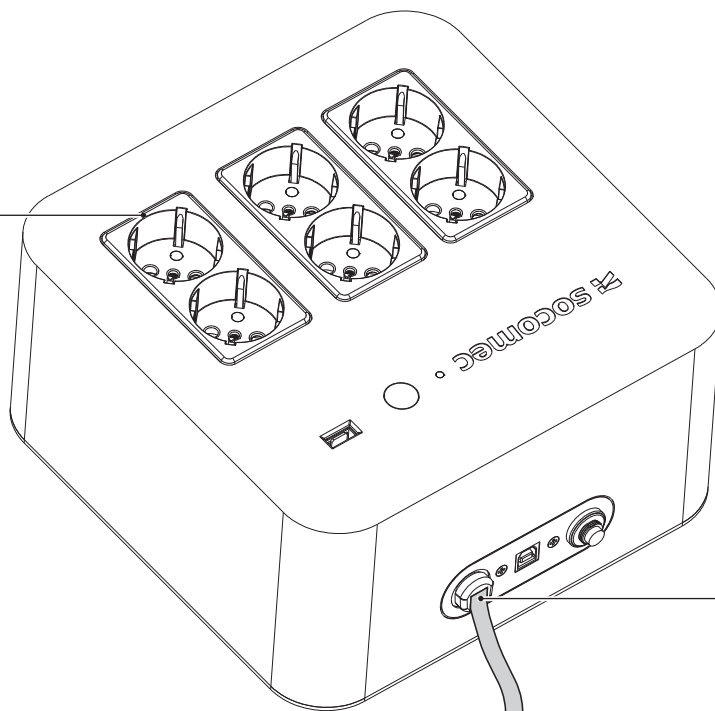

**IN 230 V~**  
Connect the UPS  
power cord to the  
mains power supply.

# 7. MODES OF OPERATION

## 7.1 SWITCHING THE UPS ON



**Note:**  
The UPS will only switch on if the battery has enough charge.

### 7.1.1 SWITCHING THE UPS ON WITH MAINS PRESENT

Switch the UPS on by pressing the ON/OFF button on the front panel.

The Normal Mode LED will light up; allow ten seconds for the self-configuration procedures to run..

The UPS is set at the same frequency (50 or 60 Hz) and the load is protected and powered.

### 7.1.2 SWITCHING THE UPS ON WITHOUT MAINS

Switch the UPS on by pressing the ON/OFF button on the front panel.

The Normal Mode LED will light up; allow ten seconds for the self-configuration procedures to run.

The UPS will run in battery mode at 50 Hz.

## 7.2 SWITCHING THE UPS OFF



**WARNING!**  
This UPS has been designed to control and maintain the battery charge; therefore it should only be switched off completely in exceptional circumstances.

To shut the UPS down completely, press and hold down the ON/OFF button down. The UPS switches off all LEDs and is then fully disabled. If the mains cable is not disconnected the battery charger remains active.

## 7.3 NORMAL MODE

When mains power is within the acceptable range, the Normal Mode LED indicator on the front panel stays on permanently. Loads are powered from the mains power supply directly; the charger works in all conditions.

## 7.4 BATTERY MODE

The UPS automatically switches to this operating mode when mains power fails (spikes or lengthy power cuts) or if the mains is at a value considered to be dangerous; users are powered using the energy stored in the batteries converted to an AC voltage through the inverter.

In this mode, a slow intermittent alarm sounds, and the Battery Mode LED indicator on the front panel flashes.

In the case of prolonged mains failure, the UPS powers loads until it shuts down when the batteries are fully depleted.

Just before shutdown, when the battery charge runs out fully, low battery charge is signalled via a rapid intermittent acoustic alarm.

The UPS automatically returns to normal operating mode when the mains power is restored.

## 7.5 OVERLOAD

The UPS can power loads up to the power rating stated on the machine's data plate at the rated mains voltage; once this limit is exceeded, the machine goes into overload conditions. Overloads are signalled by a rapid alarm.



**WARNING!**  
Significant overloads could cause permanent damage to the UPS!  
Avoid connecting laser printers that generate absorption peaks liable to cause overloads on the UPS.

## 8. COMMUNICATION

The UPS provides excellent protection against interruptions or imperfections in the mains power supply. In such cases the computer (load) is powered by the UPS using battery power until this runs out.

Various software applications and communication options are available to optimise operation of the UPS and to correctly manage shutdown when backup power ends. The status of the UPS can be monitored, keeping track of all mains failures and battery discharges so as to activate an automatic and orderly procedure to close the programs and shut down the system. When mains power returns the system will restart automatically.

All Netys PL models are equipped with a USB communication interface (not available on the standard model).

### 8.1 SOFTWARE OPTIONS

Software for monitoring and shutdown can be used on NETYS PL thanks to its USB connection. These solutions have been specially designed for the efficient management of power protection devices.

Local View ideal UPS monitoring and shutdown point-to-point solution for Windows®, Linux® and Mac OS X® operating systems.

Visit [www.socomec.com](http://www.socomec.com) to find the communication software suitable for your requirements.

## 9. SOLUTIONS TO MINOR PROBLEMS

Optimal operation of the unit is obtained by keeping it constantly powered (24 hours a day). This guarantees correct maintenance of the battery charge.

	<b>WARNING!</b> The UPS internally generates hazardous electrical voltages.
---	--

All maintenance must only be performed by authorised personnel.

If there is difficulty in getting the UPS to work, the reason may be among those listed below. For any other problems, you are advised to contact your dealer or service organisation directly.

For quick, effective action it is important to give precise details of the fault when you call, in addition to , the model number and manufacturer's serial number which can be found on the data plate on the bottom of the UPS.

### 9.1 TROUBLESHOOTING FOR MINOR PROBLEMS



Problem	Possible cause	Solution
The UPS works in battery mode even if mains power is available	Poor connection to the input mains	Check the cable connection going to the UPS and the mains outlet
	The mains voltage is out of range	No solution because mode of operation is correct
	Input protection triggered (blown fuse or automatic switch)	Replace the input fuse with another of the same type or reset the automatic switch
Backup time shorter than expected	Batteries not fully charged	Leave the batteries to charge for 8 hours consecutively
	Batteries not working properly	Have the batteries replaced by authorised personnel
The UPS stalls/goes into overload	Overload on the load line	Check that the load applied is not greater than the maximum permitted or reduce the load power requirement

	If the equipment is to be left unused for a long period, wait for the batteries to charge fully before switching off. While the UPS is not being used ensure the batteries are recharged for 24 hours at least once every 4 weeks.
---	--

## 10. BATTERY REPLACEMENT

For authorised personnel only!

- Servicing of batteries should be performed or supervised by personnel knowledgeable about batteries and required precautions.
- When replacing batteries, replace with the same type and number of batteries or battery packs.

	<b>CAUTION</b> Do not dispose of batteries in a fire. The batteries may explode.
	<b>CAUTION</b> Do not open or mutilate batteries. Released electrolyte is harmful to the skin and eyes. It may be toxic.
	<b>CAUTION</b> A battery can present a risk of electrical shock and high short circuit current. The following precautions should be observed when working on batteries.

- Remove watches, rings or other metal objects.
- Use tools with insulated handles.
- Wear rubber gloves and boots.
- Do not lay tools or metal parts on top of batteries.
- Disconnect the charging source prior to connecting or disconnecting battery terminals.
- Determine if battery is inadvertently grounded. If inadvertently grounded, remove source from ground. Contact with any part of a grounded battery can result in electrical shock. The likelihood of such shock can be reduced if such grounds are removed during installation and maintenance.

# 11. TECHNICAL SPECIFICATIONS

Models	NPL-0600-D NPL-0600-F	NPL-0800-D NPL-0800-F
Power (UPS protection)	600VA	800VA
	360W	480W
Technology	High Frequency Step Wave	
<b>Electrical specifications - Input mains</b>		
Input nominal voltage	230 Vac	
Input mains voltage	180 ± 270Vac	
Frequency (nominal)	50/60 Hz with automatic selection	
Input mains connection	Cable with plug	
<b>Electrical specifications - Output</b>		
Voltage (in Battery Mode)	230 Vac ±10%	
Frequency (in Battery Mode)	50/60 Hz ±1 Hz (default 50 Hz)	
Wave form	Step wave	
Protection	Overload, deep discharge and short circuit	
Load connection socket	n° 4 load connection socket for UPS and surge protection n° 2 load connection socket for surge protection	
USB Charger	5 Vdc, 0.5A	
Short-Circuit Current (as required by IEC 62040-1)	439 Apk / 9.6 Vrms	464 Apk / 10.6 Vrms
Applicable power grid power distribution system	TN	
<b>Battery</b>		
Typical backup time (PC + LCD monitor)	15 min	20 min
Battery type	Sealed lead acid	
Battery recharge	Under permanent charge even when the UPS is off (mains present)	
Recharge Time	6 – 8 h typical	
<b>Environment</b>		
Noise level at 1 metre	< 40 dBA	
Operating temperature	0-40 °C (15-25 °C for optimum battery life)	
Storage Temperature	-20 - +50 °C	
Environment	Humidity: 90% non-condensing	
Operating Altitude	2000 m (6562 ft) above sea level	
Storage Altitude	2000 m (6562 ft) above sea level	
Pollution	PD2	
Overvoltage category	II for normal mode	
Enclosure	IP20	
Reference Standards	IEC 62040-1; EN IEC 62040-1; IEC 62040-2; EN IEC 62040-2	
Product certification	CE	
<b>Mechanical characteristics</b>		
Dimensions (W x D x H) mm	220 x 220 x 123	
Net weight kg	3.6	4.1





# Socomec: our innovations supporting your energy performance

**1** independent manufacturer

**3,900** employees  
worldwide

**8** % of sales revenue  
dedicated to R&D

**400** experts  
dedicated to service provision

## Your power management expert



POWER  
SWITCHING



POWER  
MONITORING



POWER  
CONVERSION



ENERGY  
STORAGE



EXPERT  
SERVICES

## The specialist for critical applications

- Control, command of LV facilities
- Safety of persons and assets
- Measurement of electrical parameters
- Energy management
- Energy quality
- Energy availability
- Energy storage
- Prevention and repairs
- Measurement and analysis
- Optimisation
- Consultancy, commissioning and training

## A worldwide presence

**12** production sites

- France (x3)
- Italy (x2)
- Tunisia
- India
- China (x2)
- USA (x2)
- Canada

**30** subsidiaries and commercial locations

- Algeria • Australia • Austria • Belgium • China
- Canada • Dubai (United Arab Emirates) • France (x2)
- Germany • India • Indonesia • Italy • Ivory Coast
- Netherlands • Poland • Portugal • Romania • Serbia
- Singapore • Slovenia • South Africa • Spain • Sweden
- Switzerland • Thailand • Tunisia • Turkey • UK • USA

**80** countries

where our brand is distributed



552541A - EN 07.2023

### HEAD OFFICE

#### SOCOMECC GROUP

SAS SOCOMECC capital 10 582 640 €  
R.C.S. Strasbourg B 548 500 149  
B.P. 60010 - 1, rue de Westhouse  
F-67235 Benfeld Cedex  
Tel. +33 3 88 57 41 41 - Fax +33 3 88 57 78 78  
info.scp.isd@socomecc.com

### YOUR DISTRIBUTOR / PARTNER

[www.socomecc.com](http://www.socomecc.com)



**100** years  
OF SHARED ENERGY

**socomecc**  
Innovative Power Solutions