

Multifunction meter

DIRIS A-100 / A-200



www.socomec.com
To download, brochures,
catalogues and technical manuals.

CONTENTS

1. HAZARDS AND WARNINGS	6
1.1. Risk of electrocution, burns or explosion	6
1.2. Risk of damaging the device	6
1.3. Responsibility	7
2. PRELIMINARY OPERATIONS	7
3. INTRODUCTION	8
3.1. DIRIS A-100 / A-200 presentation	8
3.1.1. Range	8
3.1.2. Principle	9
3.1.3. Functions	10
3.1.4. Dimensions [in]/mm	12
3.1.5. Front panel	12
3.2. Presentation of associated current sensors	14
3.2.1. TE solid-core current sensors	15
3.2.1.1. Range	15
3.2.1.2. Dimensions	16
3.2.2. TR/ITR split-core current sensors	17
3.2.2.1. Range	17
3.2.2.2. Dimensions	17
3.2.3. 333mV current transformers	18
3.2.4. TF flexible current sensors	19
3.2.4.1. Range	19
3.2.4.2. Dimensions	19
3.2.5. Core-balanced Solid-core toroids (ΔIC)	20
3.2.5.1. Range	21
3.2.5.2. Dimensions	22
3.2.6. DIRIS Digiware T-10 adaptor	23
3.2.7. Accessories for ΔIC residual CTs	24
4. INSTALLATION	25
4.1. Recommendations and safety	25
4.2. Installing DIRIS A-100 / A-200	25
4.3. Installing TE solid-core sensors	26
4.3.1. Mounting accessories	26
4.3.2. DIN rail mounting	26
4.3.3. Plate mounting	28
4.3.4. Installing on a cable with clamping collar	30
4.3.5. Bar mounting	31
4.3.6. Sensors assembly	32
4.3.7. Sealing accessories for sensors	32
4.4. Installing TR split-core sensors	33
4.4.1. Cable mounting	33
4.5. Installing TF Flexible current sensors	34
4.5.1. Cable or bus bar-mounting	34

4.6. Installing Core-balanced toroids	35
4.6.1. Recommendations for the installation of core-balanced toroids around distribution cables . . .	35
4.6.2. Centering accessory	36
4.6.3. DIN rail mounting accessory compatible with Δ IC (\varnothing 15 – 120 mm)	37
4.6.4. Mounting with metal bracket.	38
4.7. installing 333mV current transformers	39
4.8. installing solid-core TCL-B 333mV current transformers	41
5. CONNECTION	42
5.1. DIRIS A-100 / A-200 connection.	42
5.2. Connection to the electrical network and to the loads.	44
5.2.1. Configurable loads based on the network type.	44
5.2.2. Description of the main network and load combinations.	45
5.2.3. Line voltage and load connections for RJ12 smart sensors models	46
5.2.4. Line voltage and load connections for 333mV current transformers models	47
6. COMMUNICATION	48
6.1. Modbus General information	48
6.2. RS485 rules	48
6.3. Modbus and BACnet communication tables	48
7. CONFIGURATION	49
7.1. Connection modes for remote configuration	49
7.2. Configuration via Easy Config System.	50
7.2.1. USB connection mode	50
7.2.2. Ethernet connection mode	51
7.3. Configuration from the display.	54
7.3.1. Navigation.	54
7.3.2. Description of the Wizard	55
7.3.3. Complete configuration.	55
7.4. Screen menu structure	57
8. USE	58
8.1. Browse	58
8.2. Shortcuts	58
8.3. Favourites	58
8.4. Screen display of measurements.	58

9. WEBSERVER EMBEDDED IN THE DIRIS A-200	59
9.1. User profiles	59
9.2. Admin profile	62
9.2.1. “Devices” menu	62
9.2.2. “Protocols” menu	64
9.3. Cyber security profile	68
9.3.1. Cyber security menu	68
9.3.2. “Security Policy” tab	69
9.3.3. “HTTPS” tab	70
9.3.4. CAs (FTPS/SMTPS) tab	70
9.3.5. “Firewall” tab	71
9.3.6. Upgrading the firmware of the A-200	71
9.4. WEBVIEW-S	73
10. CHARACTERISTICS	74
10.1. DIRIS A-100 / A-200 characteristics	74
10.1.1. Mechanical features	74
10.1.2. Electrical specifications	74
10.1.3. Measuring characteristics	74
10.1.4. Input/output characteristics	75
10.1.5. Communication specifications	76
10.1.6. Environmental specifications	76
10.1.7. Electromagnetic compatibility	77
10.1.8. Safety	78
10.1.9. Service life	78
10.2. TE, TR / iTR and TF sensor characteristics	79
11. PERFORMANCE CLASSES	81
11.1. Specification of the characteristics	81

ANNEX I. FTP CONFIGURATION	82
Annex I - 1. FTP file export protocol	82
Annex I - 1.1. FTP server activation:	82
Annex I - 2. FTP planning configuration	84
Annex I - 3. Understanding the exported .csv file in EMS mode.	85
ANNEX II. FIND AND ADD A SERVER'S CA (CERTIFICATE AUTHORITY) TO A DIRIS A-200	86
ANNEX III. TIME OF USE	90
Annex III - 1. General information	90
Annex III - 2. Setup the time of use.	90
Annex III - 2.1. STEP 1: Configure general settings and holidays	90
Annex III - 2.2. Step 2: Configure your seasons	93
Annex III - 2.3. Step 3: Configure your rates	95
Annex III - 2.4. Step 4 (Optional): Configure alternate days	96
Annex III - 2.5. Step 5: Finalizing your configuration	97
Annex III - 3. Viewing your time of use information	98
ANNEX IV. WAVEFORMS	100
Annex IV - 1. Waveforms real-time (scope mode):	100
Annex IV - 2. Waveforms capture upon event	102
Annex IV - 2.1. General information.	102
Annex IV - 2.2. Setup	103
Annex IV - 2.3. Visualization	105



1. HAZARDS AND WARNINGS

The term "device" used in the paragraphs below refers to the DIRIS A-100 / A-200.

The assembly, use, servicing and maintenance of this product must only be carried out by trained, qualified professionals.

SOCOMECC shall not be held responsible for failure to comply with the instructions in this manual.

1.1. Risk of electrocution, burns or explosion

	Caution: risk of electric shock	Ref. ISO 7000-0434B (2004-01)
	Caution: refer to the accompanying documentation each time this symbol is shown	Ref. ISO 7010-W001 (2011-05)



- Only duly authorised and qualified personnel may work or install/uninstall the device.
- The instructions are valid together with the specific instructions for the device.
- The device is designed only for its intended purpose as set out in the instructions.
- Only accessories authorised or recommended by SOCOMECC may be used in association with the device.
- Before proceeding with installation, maintenance, cleaning, disassembly, connection, or maintenance work, the device and system must be cut off from the mains to avoid electrocution and damaging the system and device.
- This device is not designed to be repaired by the user.
- For any questions related to the disposal of the device, please contact SOCOMECC.



Do NOT clamp or pull out NON-INSULATED conductors carrying DANGEROUS VOLTAGE which could cause an electric shock, burn or arc flash.
Ref. IEC 61010-2-032

Failure to comply with the instructions of the device and this safety information can cause bodily injury, electric shock, burns, death or damage to property.

1.2. Risk of damaging the device

	Caution: risk of electric shock	Ref. ISO 7000-0434B (2004-01)
	Caution: refer to the accompanying documentation each time this symbol is shown	Ref. ISO 7010-W001 (2011-05)

To ensure that the device operates correctly, make sure that:

- The device is correctly installed.
- There is a maximum voltage at the voltage measurement input terminals of 1039 V AC phase-phase or 600 V AC phase-neutral.
- There is a maximum voltage at the auxiliary power supply input terminals of 600 V AC.
- The network frequency indicated on the device is observed: 50 or 60 Hz.
- Always connect the TE, TR / iTR or TF current sensors using the recommended connection cables and observing the maximum prescribed currents.
- When the ambient temperature exceeds +50°C, the minimum temperature rating of the copper cable to be connected to terminal must be +85°C.

Failure to respect these precautions could cause damage to the device.

1.3. Responsibility

- Assembly, connection and use must be carried out in accordance with the installation standards currently in force.
- The device must be installed in accordance with the rules given in this manual.
- Failure to observe the rules for installing this unit may compromise the device's intrinsic protection.
- The device must be positioned within an installation which complies with the standards currently in force.
- Any cable which needs to be replaced may only be replaced with a cable having the correct rating.
- Despite constantly striving for quality in preparing this manual, errors or omissions are always a possibility and are not the responsibility of SOCOMEC.

2. PRELIMINARY OPERATIONS

To ensure the safety of staff and the equipment, it is vital to read and absorb the contents of these instructions thoroughly before commissioning.

Check the following points as soon as you receive the package containing the device:

- The packaging is in good condition
- The device has not been damaged during transit,
- The device part number conforms to your order
- The package includes:
 - 1 device equipped with removable terminals
 - 1 line resistor (ref. 4899 0019)
 - 1 Quick Start guide

3. INTRODUCTION

3.1. DIRIS A-100 / A-200 presentation

The DIRIS A-100 / A-200 is a compact multifunction meter with a 96*96 mm standard format. It is designed for measuring, monitoring and reporting electrical energy. The DIRIS A-100 / A-200 offers a range of functions for measuring voltage, current, power, energy and quality.

The 4 current inputs allow the product to jointly analyse single-phase and three-phase loads at the same time. More specifically it is possible to monitor up to 4 single-phase or balanced three-phase loads concurrently. On Diris A-200 it is also possible to monitor residual current with the help of a core-balanced toroid.

The DIRIS A-100 / A-200 has 3 digital inputs (pulse metering, status checking) and 1 output (Alarm or pulses). DIRIS A-100 has built in RS485 2-wires Modbus RTU communication. DIRIS A-200 also has Ethernet MODBUS TCP communication with embedded Webview webserver capability depending on the ordered reference.

If using the DIRIS A-100 and A-200 versions with RJ12 quick-connect sensors, the installation is easy and fast. Their automatic identification (type and rating) by the DIRIS A-100 / A-200 significantly reduces the risk of errors during installation. In addition, this approach, based on combining the sensor with the DIRIS A-100 / A-200, means the overall accuracy of the DIRIS A-100 / A-200 + Current sensor measurement chain can be guaranteed for all values measured.

By using core balanced toroids it is also possible to monitor residual currents*.

The product is configured from the display or via the free Easy Config System software which can be downloaded on Socomec website. The measurements can be accessed on the display of the device or via the embedded WEBVIEW web server*, enabling real-time monitoring of the electrical values and reporting of the energy data. The DIRIS A can be integrated as a standalone solution or in a multi-product configuration within an energy management system.

*in case of DIRIS A-200 with Ethernet model.

3.1.1. Range

	Models			
	DIRIS A-100	DIRIS A-100	DIRIS A-200	DIRIS A-200
RJ12 smart sensors	•		•	
333mV current transformers		•		•
RS485 Modbus RTU	•	•	•	•
Ethernet Modbus TCP			•	•
Webview software			•	•
Part No.	48250600	48250601	48250604	48250605

3.1.2. Principle

RJ12 smart current sensors

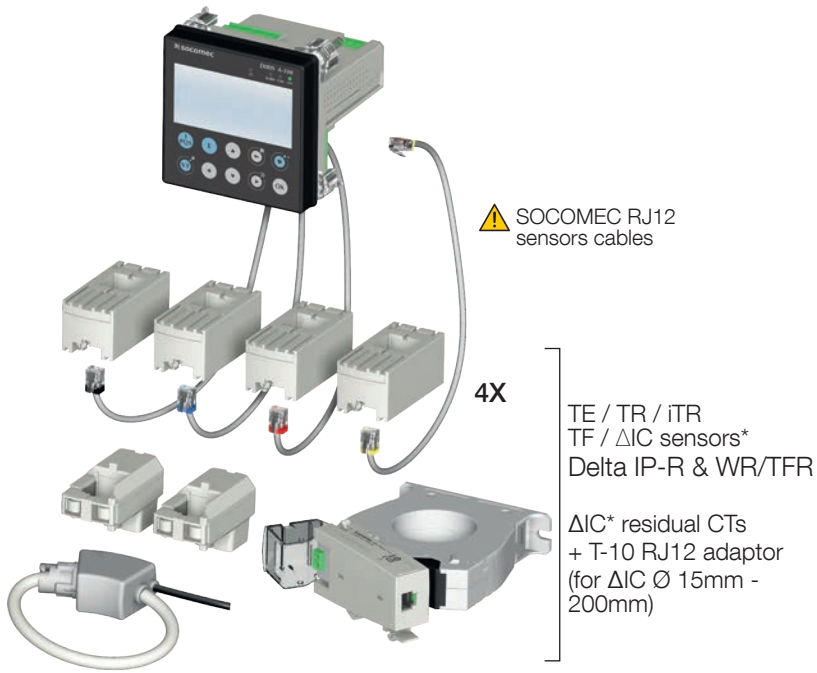

333mV current transformers models

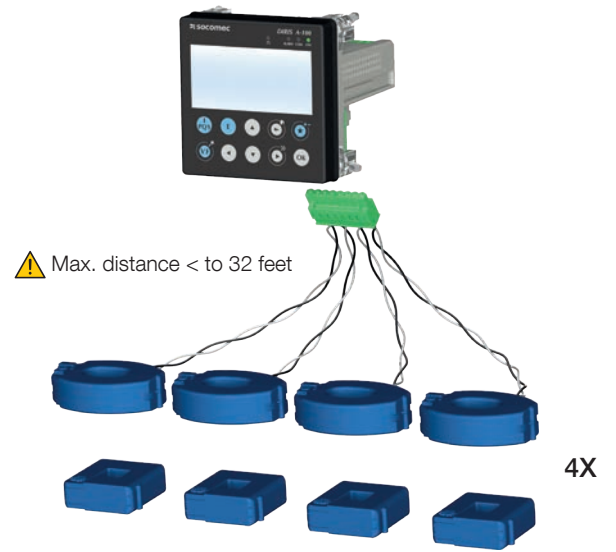

*ΔIC residual current monitoring sensors are only compatible with the DIRIS A-200 with RJ12 sensors, model 48250604, maximum one ΔIC sensor per load monitored.

3.1.3. Functions

The DIRIS A-100 / A-200 boasts numerous functions, including:

- General measurements
 - Electrical values, voltage, current, frequency
 - Power, power factor, cos phi and tan phi
 - 4 quadrant operation
 - Predictive power
 - Overall accuracy of the DIRIS A-100 / A-200 + RJ12 Sensors measurement chain guarantees up to class 0.5 (depending on the current sensor used) in power and active energy in accordance with IEC 61557-12
 - Fast metrology with RMS values computed from 20 to 200 ms
 - RCM residual current monitoring $I_{\Delta n}$ or IPE (protective earth)
 - Customizable splash screen
 - Rolling favorites screen
- Quality
 - Current, phase-to-neutral voltage and phase-to-phase voltage
 - THD, TDD and individual harmonics up to level 63 for voltage and current
 - Voltage and current crest factor
 - Voltage and current unbalance
 - K-factor
 - EN50160 events (Uswl, Udip, Uint) and current overloads
 - Waveform real-time scope mode
 - Waveform capture upon event (voltage sag, swell, interruption or current inrush) or upon powerfail
- Data log
 - Recording of averaged electrical values
 - Recording and timestamping of min/max electrical values
- Metering
 - Active, reactive, apparent energy total and partial
 - Load curves
 - Multi-tariff management through inputs, modbus, or time of use management (up to 4 seasons, 8 segments per day, with holidays, special days and week-end management)
- Alarm
 - Timestamped alarms with boolean combination
 - Advanced alarms
 - Flashing alarm display
- Connection to the network
 - 4 current inputs with automatic recognition of the current sensors via a quick connection cable (RJ12 type)
 - Simultaneous management of several single-phase, two-phase and three-phase loads- Control of the connection, detection of the current sensors and auto-configuration of the networks
 - Guaranteed overall accuracy of the DIRIS A-100 / A-200 + Sensors measurement chain in accordance with IEC 61557-12
- Inputs/outputs
 - 3 logic inputs
 - 1 logic output
- Communication
 - RS485 Modbus RTU and Ethernet (Modbus TCP, BACnet IP)
- Web Server
 - Embedded Web Server for the DIRIS A-200 ethernet (Réf. 4825 0604 and 4825 0605)

Reference	DIRIS A-100		DIRIS A-200	
	4825 0600	4825 0601	4825 0604	4825 0605
Number of current inputs	4	4	4	4
RS485 2-wires MODBUS RTU	•	•	•	•
Dual-Ethernet port with MODBUS TCP and BACnet IP			•	•
RJ12 smart sensors	•		•	
333mV current transformers		•		•
Metering				
Total and partial Ea+, Ea-, Er+, Er-, Eap		•	•	•
Multi-tariff (max. 4)		•	•	•
Time of use management		•	•	•
Multi-measurement				
VA, VB, VC, Vn, UAB, UBC, UCA, f		•	•	•
I1, I2, I3, IN		•	•	•
ΔN, IPE RCM			•	
P, Q, S, PF per phase, ΣP, ΣQ, ΣS, ΣPF		•	•	•
Predictive power P, Q, S		•	•	•
Phi, cos Phi, tan Phi		•	•	•
Virtual Monitor & auto-correct technology	• (with iTR)		• (with iTR)	
Fast metrology RMS values (from 20 to 200ms)			•	•
Quality				
Voltage unbalance Vnba, Vnb, Unba, Unb		•	•	•
Current unbalance Inba, Inb		•	•	•
THDI1, THDI2, THDI3, THDI _n , THD I _{sys} , TDD		•	•	•
Individual harmonics V, U, I (up to rank 63)		up to 25	•	•
Crest Factor, k-factor		•	•	•
Voltage swells, Voltage dips, Supply voltage interruptions according to EN50160			•	•
Overcurrents / inrush			•	•
Waveform scope mode			•	•
Waveform capture upon events			•	•
Waveform capture upon power fail			•	•
Alarms				
User-defined with thresholds		•	•	•
Digital input alarms		•	•	•
Boolean combination alarms		•	•	•
System alarms		•	•	•
Alarms on event		•	•	•
Alarm and event log		•	•	•
RCM and comparison alarm			•	
Load shedding alarms		•	•	•
Protection alarms		• (with iTR)	• (with iTR)	• (with iTR)
Flashing alarm display			•	•
Inputs / Output				
Amount of I/Os	3 inputs / 1 output		3 inputs / 1 output	
Data logging				
Average values / trends (100 days depth in period 10 min)			•	•
Load curves (1 year depth in period 15 min)			•	•
Energy consumption curves (4 years depth in period 60 min)			•	•
Waveform capture of events (100 set of waveforms, 7 per set)			•	•
System / Alarms / Quality events (Last 500 of each stored)			•	•
Other				
Rolling favorites screen		•	•	•
Custom screens (up to 4)		•	•	•
Customizable splash screen		•	•	•
Web Server				
Webview software	• (as an option in combination with DIRIS D-70/M-70 gateway)		• (embedded)	
Communication				
SNTP, SMTP(S), FTP(S), HTTP(S), MODBUS TCP, BACNET IP, DHCP			•	•
Compliance to cybersecurity standard IEC 62443			•	•
Modbus secure (SB327, Modbus TCP over TLS)			•	•
TLS/SSL certificates support			•	•

3.1.4. Dimensions [in]/mm

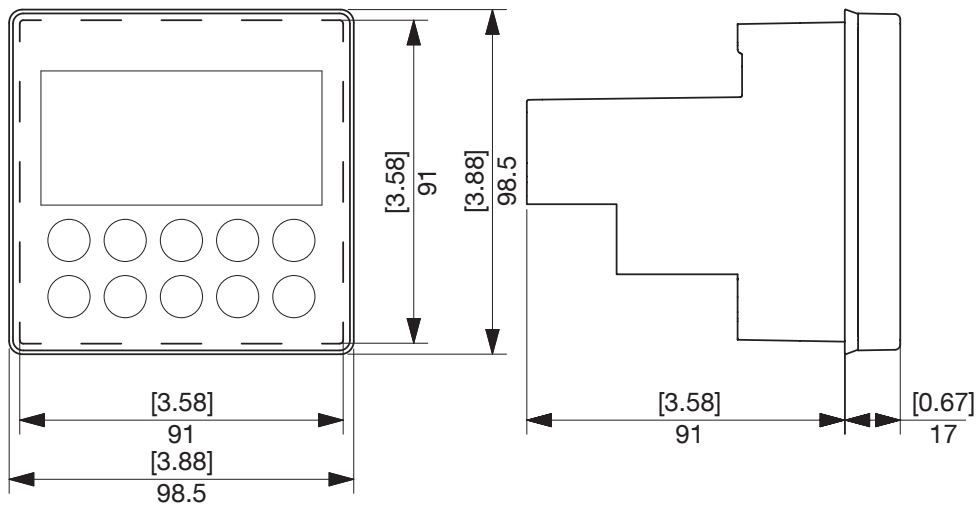



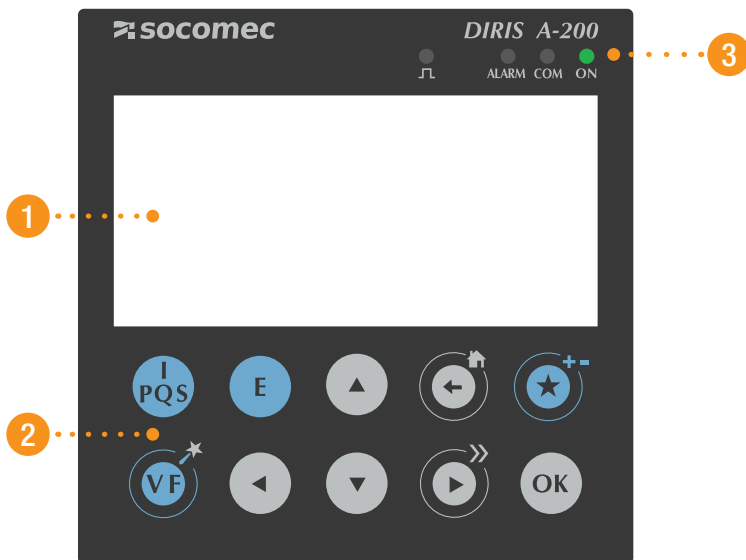

3.1.5. Front panel

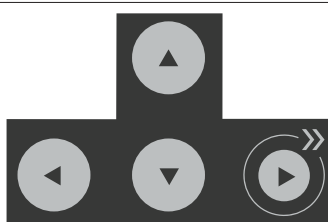

1. Screen 350x160
2. 10 capacitive touch keys
3. LEDs

The display consists of a screen and 10 keys:

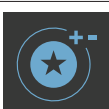
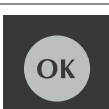
	Shortcut keys for load measurements: current, active power, reactive power, apparent power, power factor, cos phi
	Shortcut keys for electrical network measurements: phase-to-neutral voltage, phase-to-phase voltage, frequency Shortcut keys for the Wizard by holding down
	Shortcut keys for active, reactive, apparent energy meters (total and partial values)
	Arrow keys for navigation, by holding down right arrow allows to cycle to the next load
	Use this to go up a level in the display navigation menus and to return to the main menu by holding down
	Use this to save favourite screens by holding down and then to view them with a short press Use this to remove favourite screens by holding down
	Use this to confirm your navigation or entry selection

LED display:



	FIXED	BLINKING
ALARM MAINS (Red)	Ongoing alarm (measurement value, over / under range protection)	Ongoing system alarm (disconnected CT, V/I association, incorrect CT rating)
COM (Orange)	N/A	Device is communicating
ON (Green)	Product powered and operating normally	N/A
Pulse LED	Ongoing RCM alarm (if pulse set to RCM, in which case this LED doesn't display consumptions pulses anymore)	Energy consumed or produced pulses, pulse weight: 0.1 Wh (default, configurable)

3.2. Presentation of associated current sensors

Various types of current sensors are connected to the DIRIS A-100 / A-200: solid-core (TE), split-core (TR, iTR) or flexible (TF). in case of RJ12 sensors models, or 333mV current transformers on the other models. It is also possible to fit core balanced deltaIC toroids on DIRIS A-200 RJ12 version reference 4825 0604. The variety between these sensors means they can be adapted to any type of new, existing or high-current existing installation. The DIRIS A-100 / A-200 recognizes the sensor size and type. In addition, combining them means the overall accuracy of the DIRIS A-100 / A-200 + current sensor measurement chain can be guaranteed over a large measurement range.

RJ12 smart current sensors

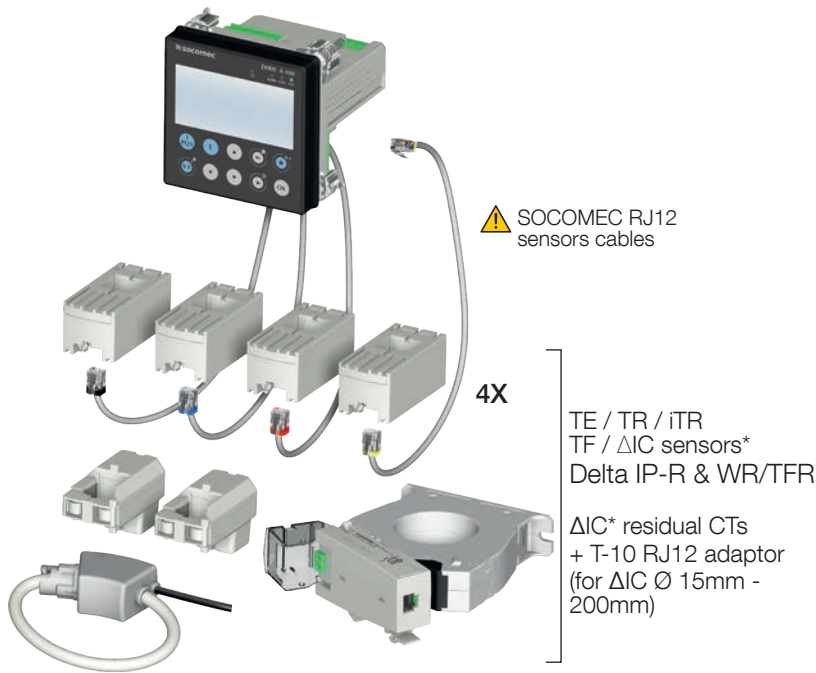

333mV current transformers models

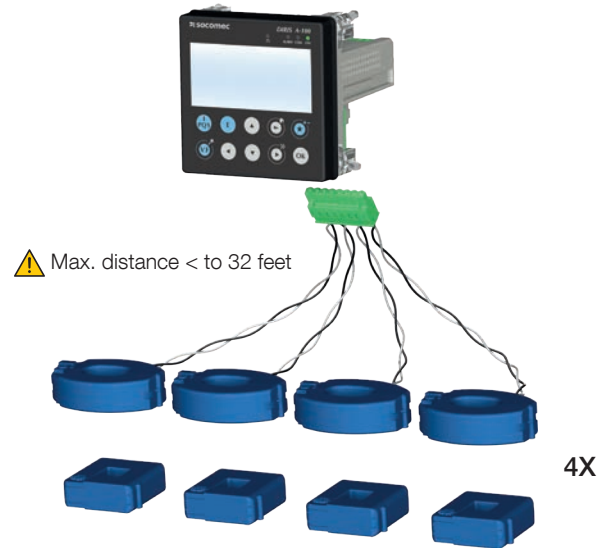

*ΔIC residual current monitoring sensors are only compatible with the DIRIS A-200 with RJ12 sensors, model 48250604; only one ΔIC sensor per DIRIS A-200.

⚠ For connecting the current sensors, use SOCOMECE cables only, RJ12 straight cables, twisted pair, unshielded, 600 V, -10°C / +70°C. It is recommended that all the current sensors are installed in the same direction.

Connection cables for current sensors:

RJ12 connection cables	Cable length (m)										
	0.1	0.2	0.3	0.5	1	2	3	5	7	10	50 m reel + 100 connectors*
Number of cables	Ref.	Ref.	Ref.	Ref.	Ref.	Ref.	Ref.	Ref.	Ref.	Ref.	Ref.
1	-	-	-	-	-	-	4829 0606	4829 0602		4829 0603	4829 0601
3	4829 0580	4829 0581	4829 0582	4829 0595	4829 0583	4829 0584	-	4829 0607	4829 0608	4829 0609	-
4				4829 0596	4829 0588	4829 0589	-	-	-	-	-
6	4829 0590	4829 0591	4829 0592	4829 0597	4829 0593	4829 0594	-	-	-	-	-







* When producing cables, do not exceed a maximum length of 10 metres.

3.2.1. TE solid-core current sensors

The TE solid-core current sensors are used to set up measurement points in a new or existing installation. They are easy to integrate as they are compact and match the pitch of the circuit breakers. A wide range of accessories are also available for direct fitting on all type of cabling (cable, flexible or rigid busbar) or on a DIN rail support or plate.

Thanks to the specific link, they are recognised by DIRIS Digiware and a high level of overall accuracy for the measurement chain is guaranteed.

3.2.1.1. Range

						
	TE-18	TE-18	TE-25	TE-35	TE-45	TE-55
Pitch	18 mm	18 mm	25 mm	35 mm	45 mm	55 mm
Nominal current range I_n	5 - 20 A	25 - 63 A	40 - 160 A	63 - 250 A	160 - 630 A	400 - 1000 A
Maximum I	24 A	75.6 A	192 A	300 A	756 A	1200 A
Part number	4829 0500	4829 0501	4829 0502	4829 0503	4829 0504	4829 0505

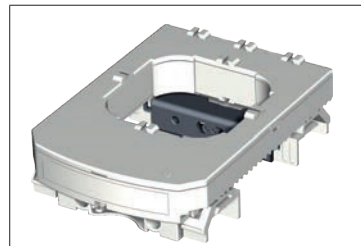

TE-90

Pitch	90 mm
Nominal current range I_n	600 - 2000 A
Maximum I	2400 A
Part number	4829 0506

3.2.1.2. Dimensions

Dimensions *in/mm*

	TE-18	TE-25	TE-35	TE-45	TE-55
Pitch	0.71 18 (staggered assembly)	0.98 25	1.37 35	1.77 45	2.16 55
LxHxD	1.10 x 0.79 x 1.77 28 x 20 x 45	0.98 x 1.28 x 2.56 25 x 32.5 x 65	1.37 x 1.28 x 2.79 35 x 32.5 x 71	1.77 x 1.28 x 3.38 45 x 32.5 x 86	2.16 x 1.28 x 3.93 55 x 32.5 x 100
Aperture (W)	Ø 0.33 Ø 8.4	0.53 x 0.53 13.5 x 13.5	0.82 x 0.82 21 x 21	1.22 x 1.22 31 x 31	1.61 x 1.61 41 x 41
(T)	-	0.69 17.5	0.69 17.5	0.77 19.5	0.85 21.5

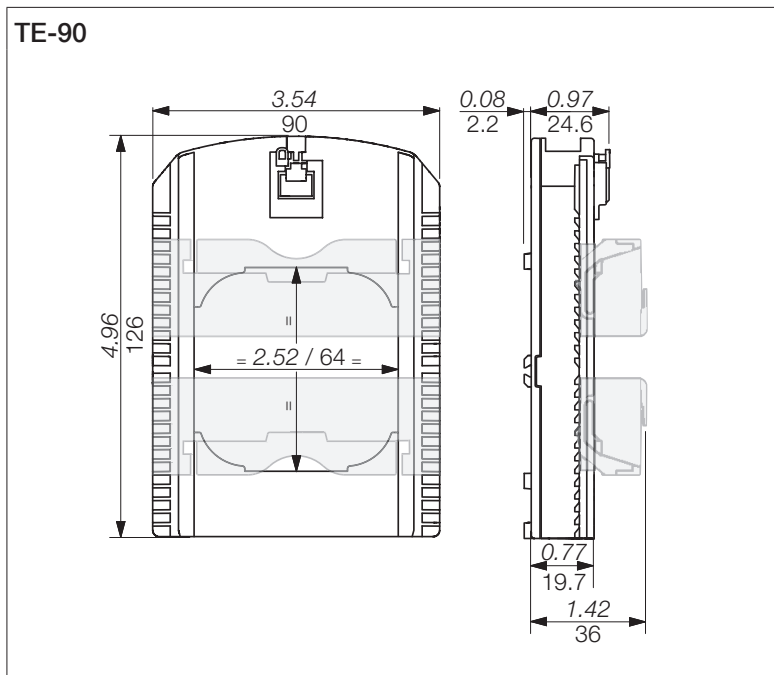





3.2.2. TR/iTR split-core current sensors

The TR/iTR split-core current sensors are used to set up measurement points in a new or existing installation without interfering with its cabling. Thanks to the specific link, they are recognised by DIRIS Digiware and the overall accuracy of the measurement chain is guaranteed.

In addition, iTR sensors detect the presence of voltage in the cable passing through them.

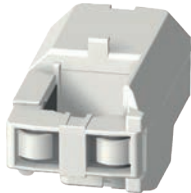

3.2.2.1. Range

Four models are available from 25A to 600A to analyse several types of loads.

				
	TR-10 / iTR-10	TR-14 / iTR-14	TR-21 / iTR-21	TR-32 / iTR-32
Cable passage diameter	Ø 10 mm	Ø 14 mm	Ø 21 mm	Ø 32 mm
Nominal current range I _n	25 - 63 A	40 - 160 A	63 - 250 A	160 - 600 A
Recommended cable section	6 mm ² (iTR-10)	10 mm ² (iTR-14)	50 mm ² (iTR-21)	50 mm ² (iTR-32)
Maximum I	75.6 A	192 A	300 A	720 A
Part number	4829 0555 / 4829 0655	4829 0556 / 4829 0656	4829 0557 / 4829 0657	4829 0558 / 4829 0658

3.2.2.2. Dimensions

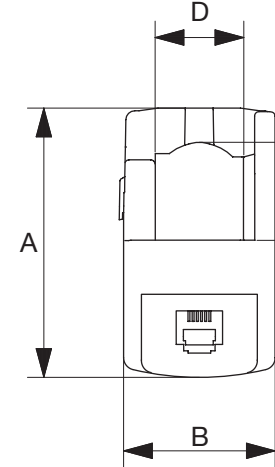
Dimensions *in/mm*

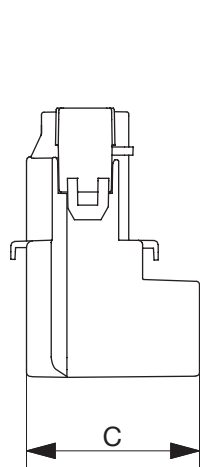
				
	TR-10 / iTR-10	TR-14 / iTR-14	TR-21 / iTR-21	TR-32 / iTR-32
A	1.74 44	2.63 67	2.56 65	3.38 86
B	1.02 26	1.14 29	1.45 37	2.08 53
C	1.10 28	1.10 28	1.69 43	1.85 47
D	-	0.55 14	0.82 21	1.26 32
E	-	0.59 15	0.90 23	1.30 33
Diameter	0.39 10	0.55 14	0.82 21	1.26 32

3.2.3. 333mV current transformers

The ACCU-CT range of split core current transformers offers exceptional linearity, very low phase angle error and a safe low voltage output 333mV.

Its wide measurement range from 20 to 600 A as well as its accuracy, class 0.5 or 1 depending on the model, make these sensors extremely efficient and versatile.

The ACCU-CT split-core are UL listed and conform to the UL2808 standard.

Dimensions (mm)

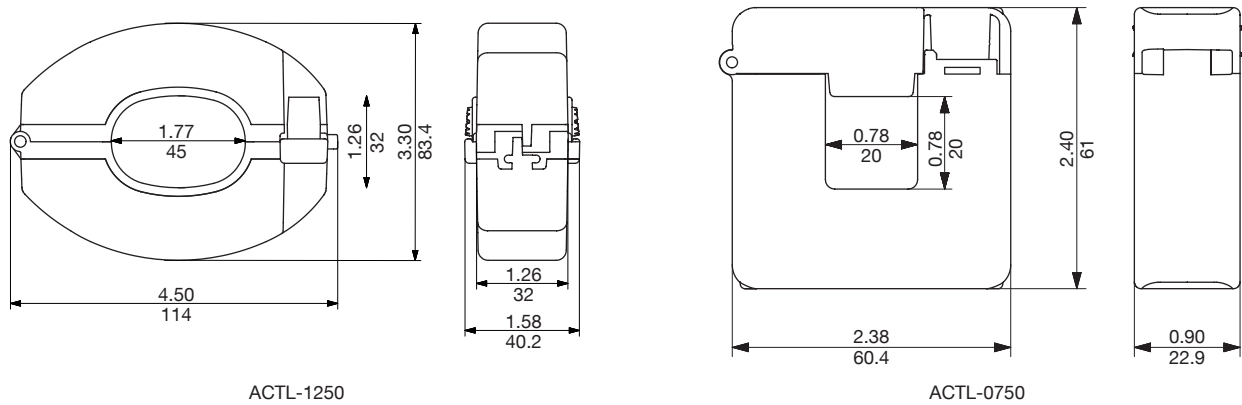

References

Primary	Secondary	Real range covered (A)	Class	Reference
20	333mV	0,2...24	0,5	USACTL0750020C06
50		0,5...60	0,5	USACTL0750050C06
100		1...120	0,5	USACTL0750100C06
150		1,5...180	0,5	USACTL0750150C06
150		1,5...180	0,2	USACTL1250150C02
200		2...240	0,5	USACTL0750200C06
250		2,5...300	0,5	USACTL0750250C06
250		2,5...300	0,2	USACTL1250250C02
300		3...360	0,2	USACTL1250300C02
400		4...480	0,2	USACTL1250400C02
600		6...720	0,2	USACTL1250600C02

3.2.4. TF flexible current sensors

The TF flexible current sensors use the Rogowski principle, covering a wide current range without saturation.

Their flexible design and easy opening system enables a quick installation inside electrical panels, making them particularly well suited for adding measuring points in existing electrical installations, especially when space is limited.

The secure lock technology prevents non voluntary openings of the Rogowski rope.

3.2.4.1. Range

Six models are available, covering a large current range up to 6000 A with openings of different shapes and sizes. They include a compact and self-supplied integrator, required to shape the current signal.

! Due to the specific RJ12 connection, the TF current sensors can only be used with DIRIS Digiware I, DIRIS B and DIRIS A-40. Used in conjunction with these PMD equipped with RJ12 connectors, the overall accuracy of the measurement chain is guaranteed.

	TF-40	TF-80	TF-120	TF-200	TF-300	TF-600
Ø (mm)	40	80	120	200	300	600
I nom. (a.c.)	100 ... 400A	150 ... 600A	400 ... 2000A	600 ... 4000A	1600 ... 6000A	1600 ... 6000A
Part number	4829 0573	4829 0574	4829 0575	4829 0576	4829 0577	4829 0578

3.2.4.2. Dimensions

Dimensions *in/mm*

	TF-40	TF-80	TF-120	TF-200	TF-300	TF-600
Diameter D	1.57 40	3.15 80	4.72 120	7.87 200	11.81 300	23.62 600
Perimeter P	4.96 126	9.88 251	14.84 377	24.72 628	37.09 942	74.21 1885
Integrator	8.04 x 0.75 x 0.6 128 x 19 x 15					

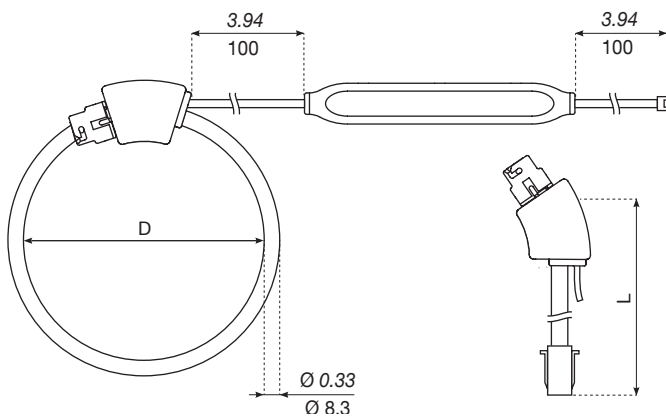

3.2.5. Core-balanced Solid-core toroids (Δ IC)

Sensors and residual CTs can be adapted to any type of new, existing or high-current existing installation. They all use a specific RJ12 link with the DIRIS A-200. This link provides a quick connection, with no cabling errors. The DIRIS A-200 device recognises the type of current sensor and its rating.

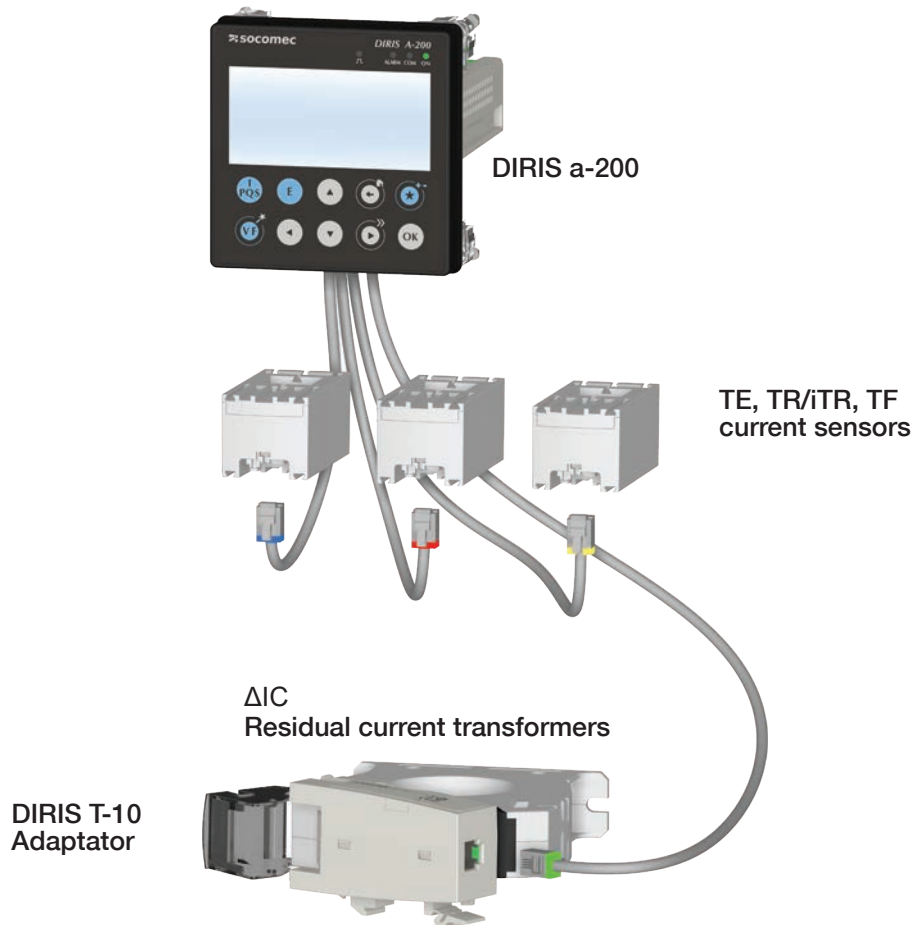

Important: to connect the current sensors, use only SOCOMEC cables, RJ12 straight cables, twisted pair, unshielded, 600 V, $-10^{\circ}\text{C} / +70^{\circ}\text{C}$ as per IEC 61010-1 version 3.0.
We recommend that all the current sensors be installed in the same direction.

Residual Current Transformers enclose active conductors, providing the differential summation of vector currents which enables the detection of leakage currents.

Solid-core (Δ IC) are available in all shapes and sizes, they are suitable for any cable/bar size and configuration.

With a choice of multiple mounting accessories, they can be mounted on a DIN rail, on a back plate or attached directly to the cable.

A centering accessory which uses a flexible clamping allows you to center the cable in residual CT, ensuring accurate measurements and better immunity to disruptions in the mains power. It also allows you to mount the residual CT directly on a cable. This system, designed without any parts, guarantees safe installation.









3.2.5.1. Range

Connection cables for current sensors:



RJ12 connection cables	Cable length (m)									
	0.1	0.2	0.3	0.5	1	2	3	5	10	50 m reel + 100 connectors*
Number of cables	Ref.	Ref.	Ref.	Ref.	Ref.	Ref.	Ref.	Ref.	Ref.	Ref.
1	-	-	-	-	-	-	4829 0606	4829 0602	4829 0603	4829 0601
3	4829 0580	4829 0581	4829 0582	4829 0595	4829 0583	4829 0584	-	-	-	-
4	-	-	-	4829 0596	4829 0588	4829 0589	-	-	-	-
6	4829 0590	4829 0591	4829 0592	4829 0597	4829 0593	4829 0594	-	-	-	-

* When producing cables, do not exceed a maximum length of 10 meters.

Δ IC circular solid-core residual current transformers

								
	Δ IC8	Δ IC15	Δ IC30	Δ IC50	Δ IC80	Δ IC120	Δ IC200	Δ IC300
Diameter	8 mm	15 mm	30 mm	50 mm	80 mm	120 mm	200 mm	300 mm
Residual Current range	3 mA - 3 A							
Reference	4829 0520	4950 6015	4950 6030	4950 6050	4950 6080	4950 6120	4950 6200	4950 6300

Δ IP-R circular split-core residual current transformers

			
	Δ IP-R50	Δ IP-R80	Δ IP-R120
Diameter	50 mm	80 mm	120 mm
Residual Current range	3 mA - 3 A		
Reference	4750 6051	4750 6081	4750 6121

WR/TFR rectangular solid-core residual current transformers

				
	WR70x175	WR115x305	WR150x350	TFR200x500
Diameter	70 x 175 mm	115 x 305 mm	150 x 350 mm	200 x 500 mm
Residual Current range	3 mA - 3 A			
Reference	4795 0717	4795 1130	4795 1535	4795 2050

3.2.5.2. Dimensions

ΔIC circular solid-core residual current transformers

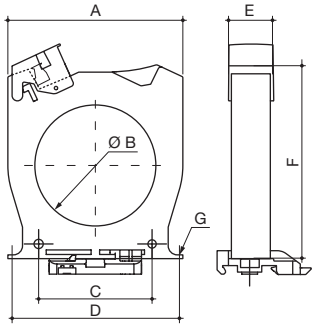

Type	A (mm)	B (mm)	C (mm)	D (mm)	E (mm)	F (mm)	G (mm)	Weight (kg)
ΔIC Ø 15	53	17.3	25	50	26	81	M4	0.10
ΔIC Ø 30	92	30	50	85	26	103.5	M4	0.15
ΔIC Ø 50	102.5	50	50	90	26	125	M5	0.27
ΔIC Ø 80	116	80	75	105	26	142.5	M5	0.38
ΔIC Ø 120	163	120	100	150	26	182.5	M6	0.72
ΔIC Ø 200	253	200	150	175x41.2	51	274	M6	1.74
ΔIC Ø 300	370	300	200	250x41.5	50	390	M6	3.60

- A. Width
- B. Diameter
- C. Spacers
- D. Rear bracket spacers
- E. Depth
- F. Height
- G. Diameter of fixing screws

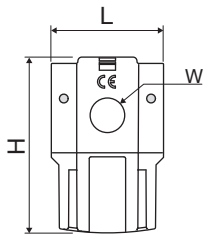

Dimensions (mm)	ΔIC ø 8
Pitch	18
LxHxD	28 x 45 x 20
Ø W	ø 8.4

3.2.6. DIRIS Digiware T-10 adaptor

Use the T-10 RJ12 adaptor to ensure the conversion and analysis of the signal between the output of the residual CT (Δ IC diameter 15 mm and above, Δ IP-R, WR and TFR residual CTs) and the DIRIS A-200.

**It can be mounted directly onto the Δ IC residual CT (diameter ≥ 30 mm) and Delta IP-R.
For other residual CTs (Δ IC \varnothing 15mm, WR and TFR), it can be mounted on a DIN rail or a back plate.**

It comes with all the connectivity required for any kind of application.

 Do not install the adaptor close to or touching any live parts, or close to breakers or other equipment carrying dangerous voltage.

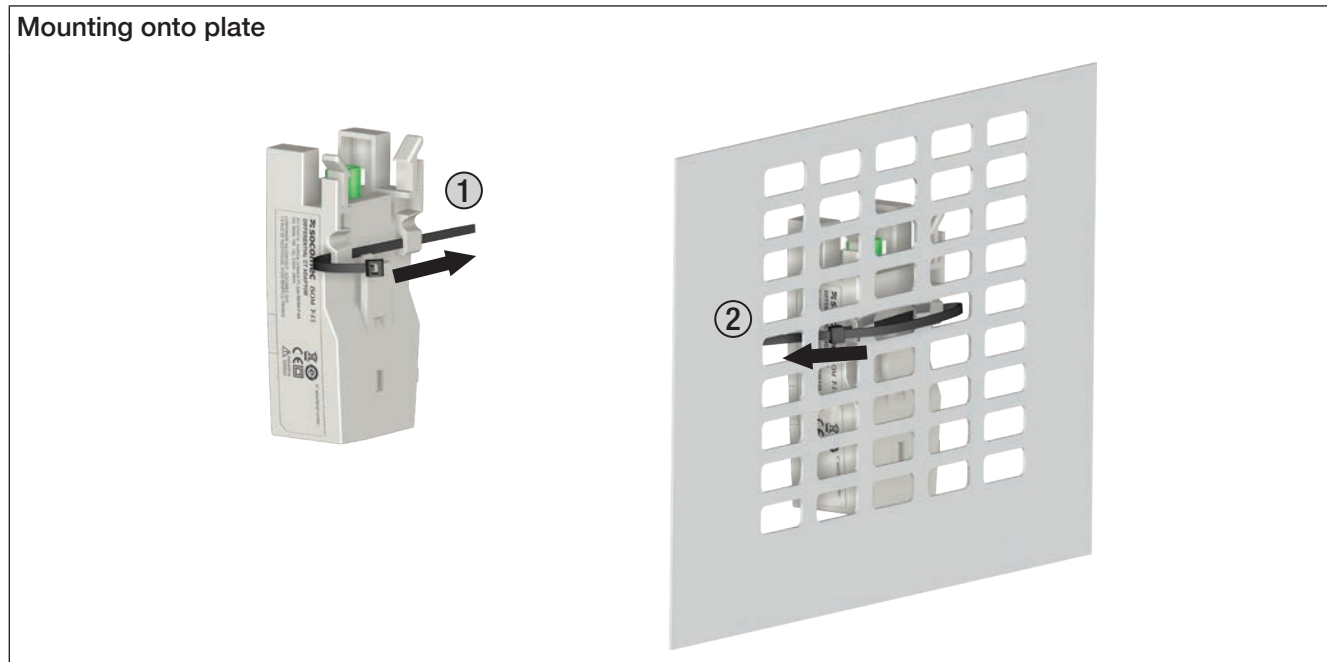

3.2.7. Accessories for Δ IC residual CTs

- Centering accessory

Flexible cable centering accessory	\varnothing (mm)	Reference
Flexible cable centering accessory	30	4950 0011
Flexible cable centering accessory	50	4950 0012
Flexible cable centering accessory	80	4950 0013
Flexible cable centering accessory	120	4950 0014



- Metal mounting bracket

Metal mounting bracket	\varnothing (mm)	Reference
Metal mounting bracket	30	4950 0001
Metal mounting bracket	50 *	4950 0002
Metal mounting bracket	80 / 120	4950 0003
Metal mounting bracket	200	4950 0004
Metal mounting bracket	300	4950 0005

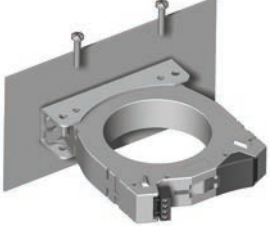

* Also compatible with Δ IP-R \varnothing 80/120 mm residual CTs

- DIN rail mounting accessory

Accessory	Reference
DIN Rail mounting accessory	4950 0031

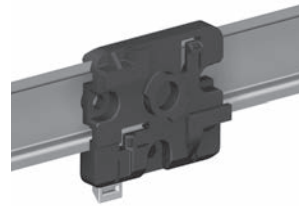

 Note: a DIN rail mounting accessory is provided with the Δ IC 8mm residual CT and the Δ IP-R range.

4. INSTALLATION

The following paragraphs describe the installation of the DIRIS A-100 / A-200 and associated sensors.

4.1. Recommendations and safety

Refer to the safety instructions (section "2. Hazards and warnings", page 6)

- Keep away from electromagnetic interference generator systems.
- Avoid vibrations with accelerations greater than 1 g for frequencies lower than 60 Hz.
- The device must not be cleaned.
- Do not install outdoor.

4.2. Installing DIRIS A-100 / A-200

The DIRIS A-100 / A-200 is to be fitted onto a door with a 92x92 mm cutout.

Dimensions: in/mm

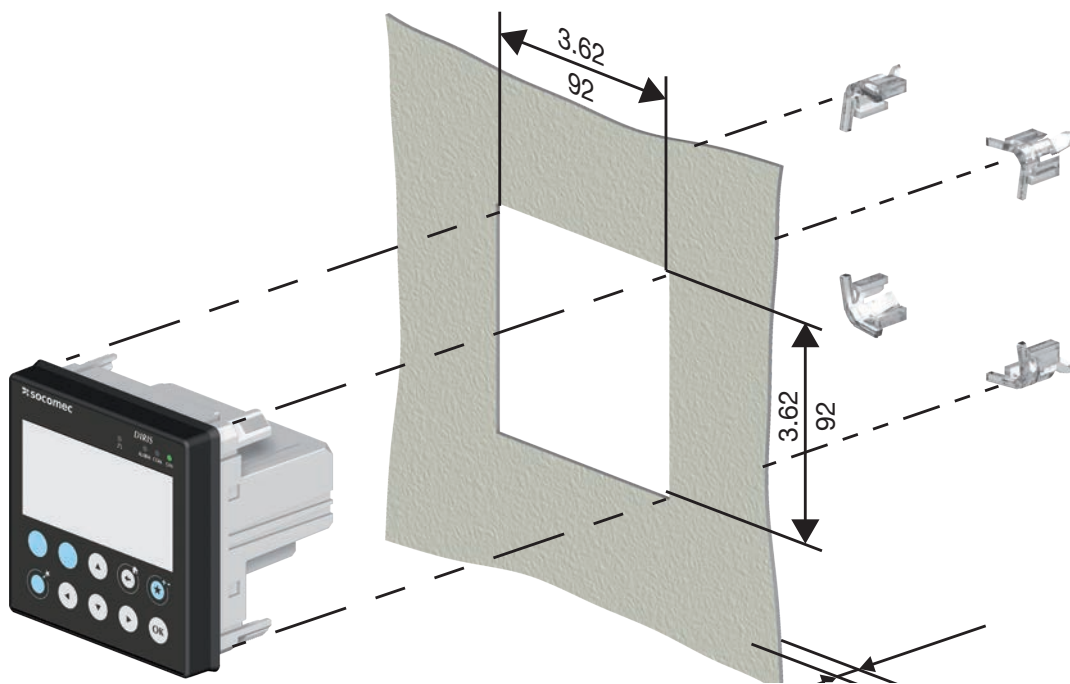

4.3. Installing TE solid-core sensors

4.3.1. Mounting accessories

The list of mounting accessories supplied with the sensors are listed below:

Reference	Pitch	DIN rail and plate mounting	DIN rail mounting	Plate mounting	Busbar mounting
4829 0500 4829 0501	TE-18 18 mm	x1			
4829 0502	TE-25 25 mm		x2	x4	
4829 0503	TE-35 35 mm		x2	x4	x2
4829 0504	TE-45 45 mm		x2	x4	x2
4829 0505	TE-55 55 mm		x2	x4	x2
4829 0506	TE-90 90 mm	x2		x6	

4.3.2. DIN rail mounting

TE-18 -> TE-55

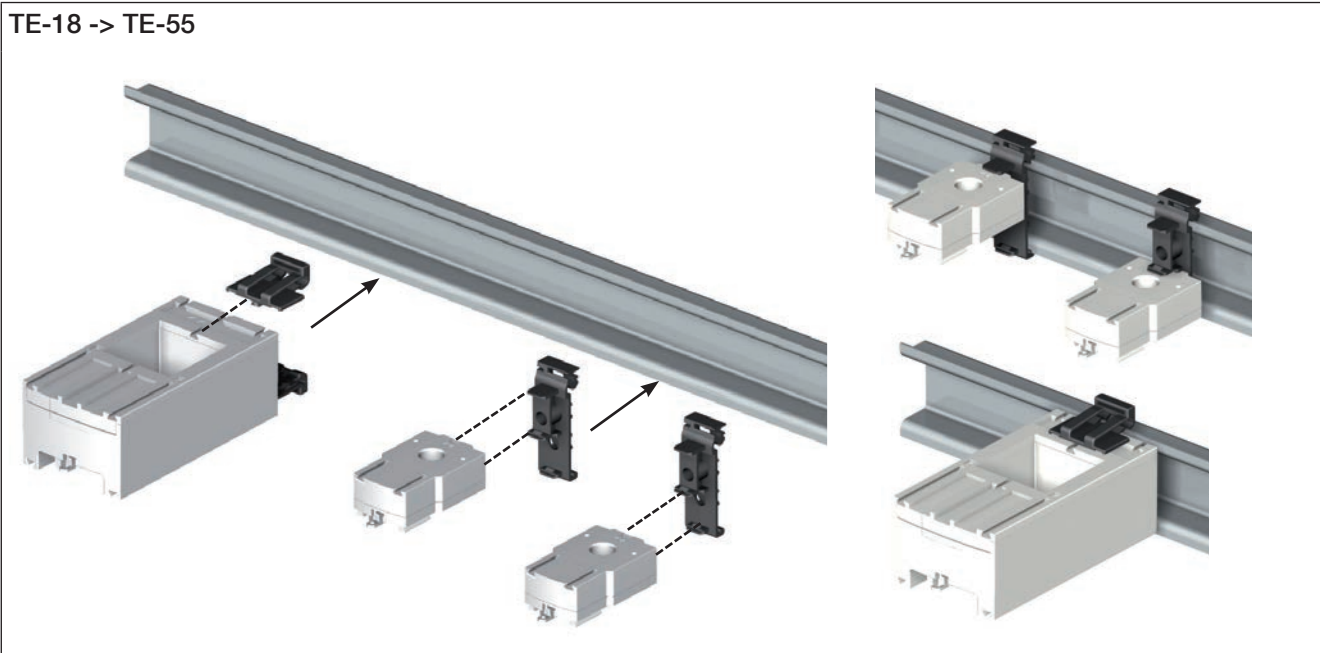

TE-90

Removing clamps

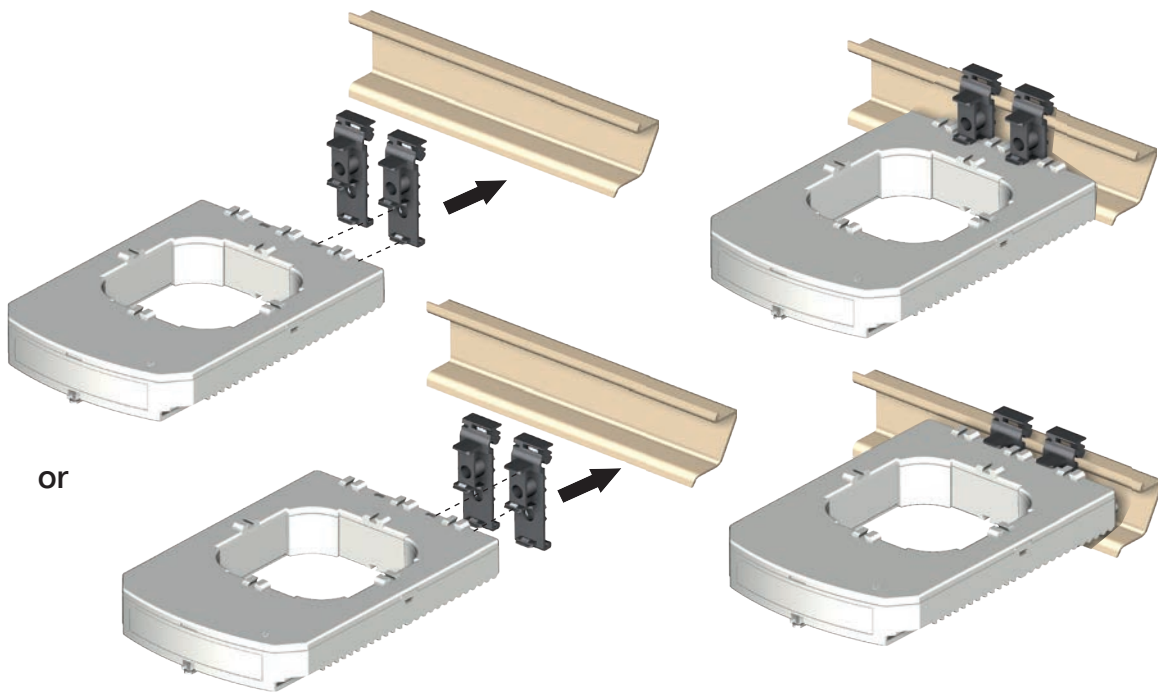
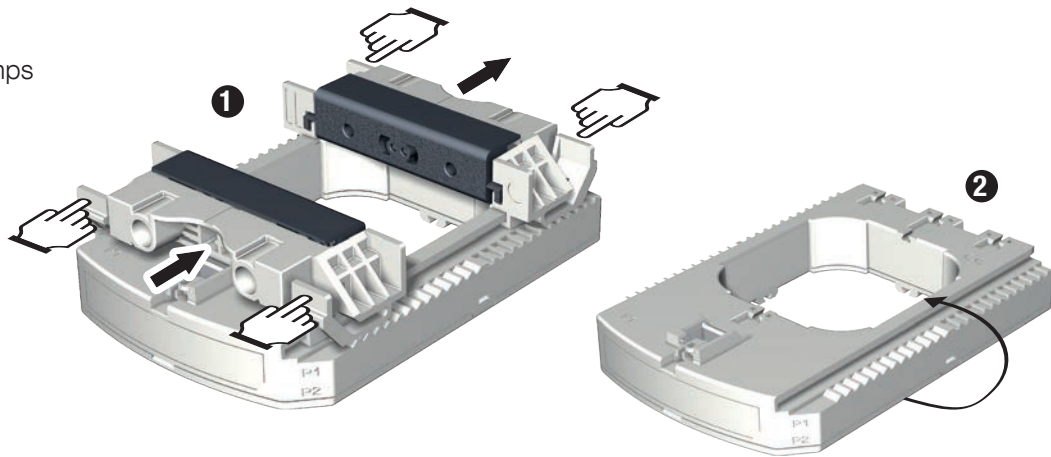

Note:

- Fix sensor TE-90 to the DIN rail to make it easier to install. This is a temporary installation.
- Use the clamps to install the TE-90 sensors on the DIN rail.

4.3.3. Plate mounting

TE-18

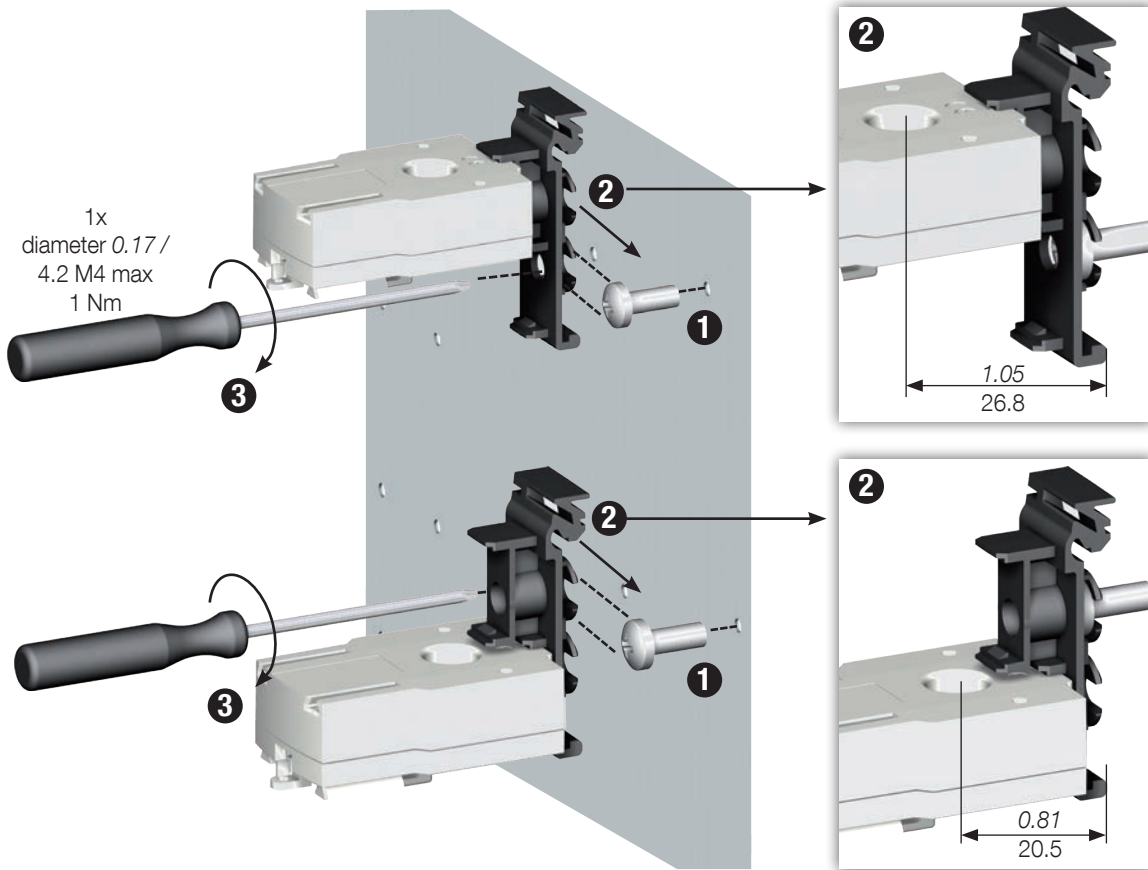

TE-25 -> TE-55

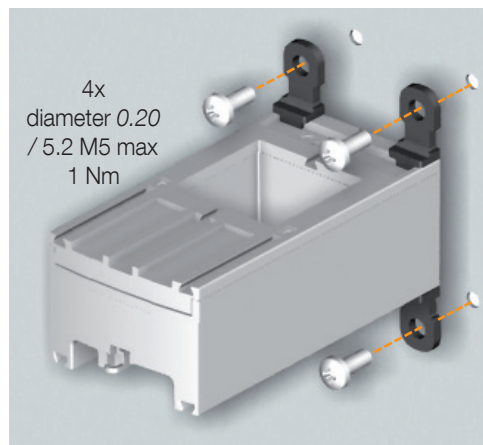

TE-90

Removing clamps

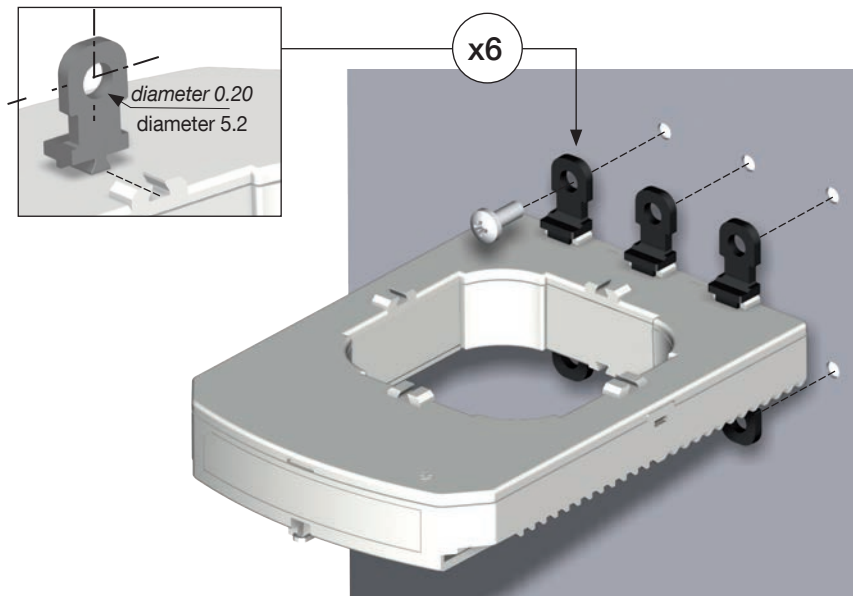
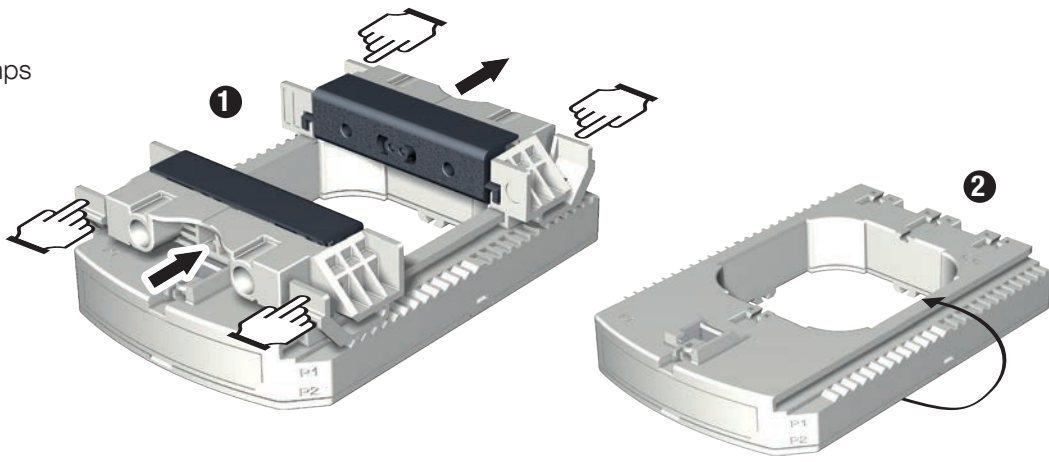

Note: Use the clamps to install the TE-90 sensors on the board.

4.3.4. Installing on a cable with clamping collar

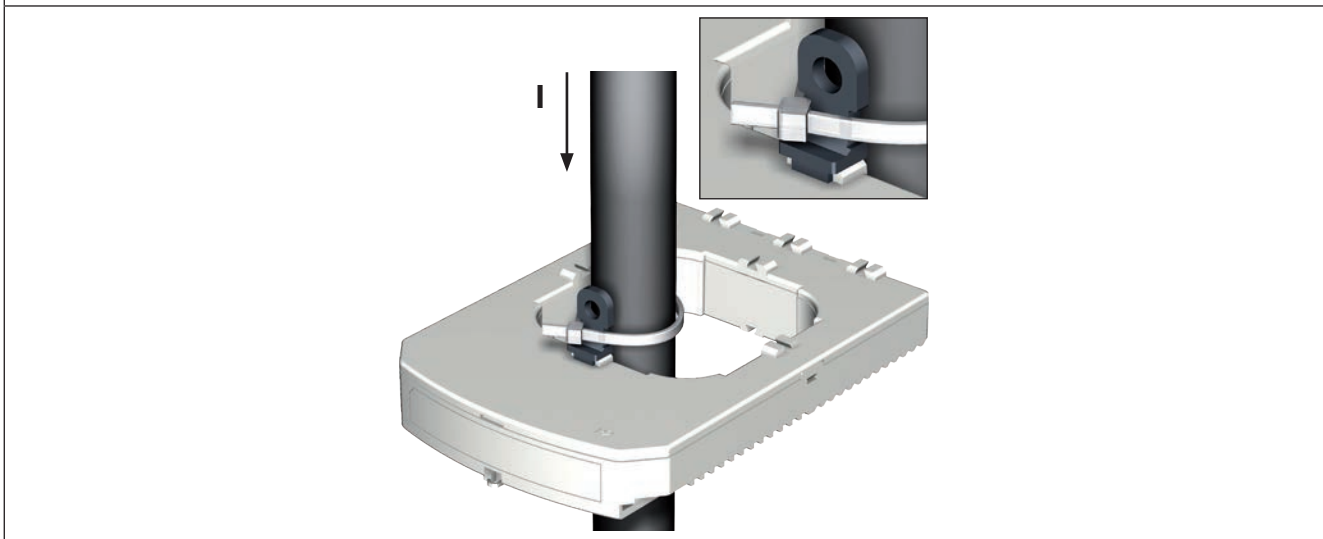
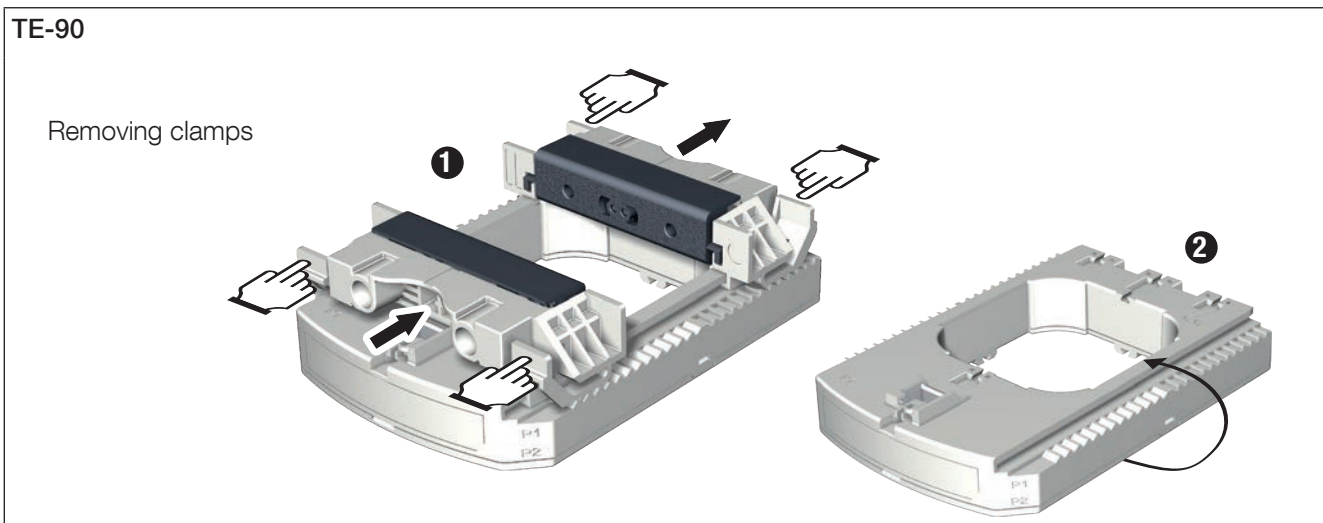
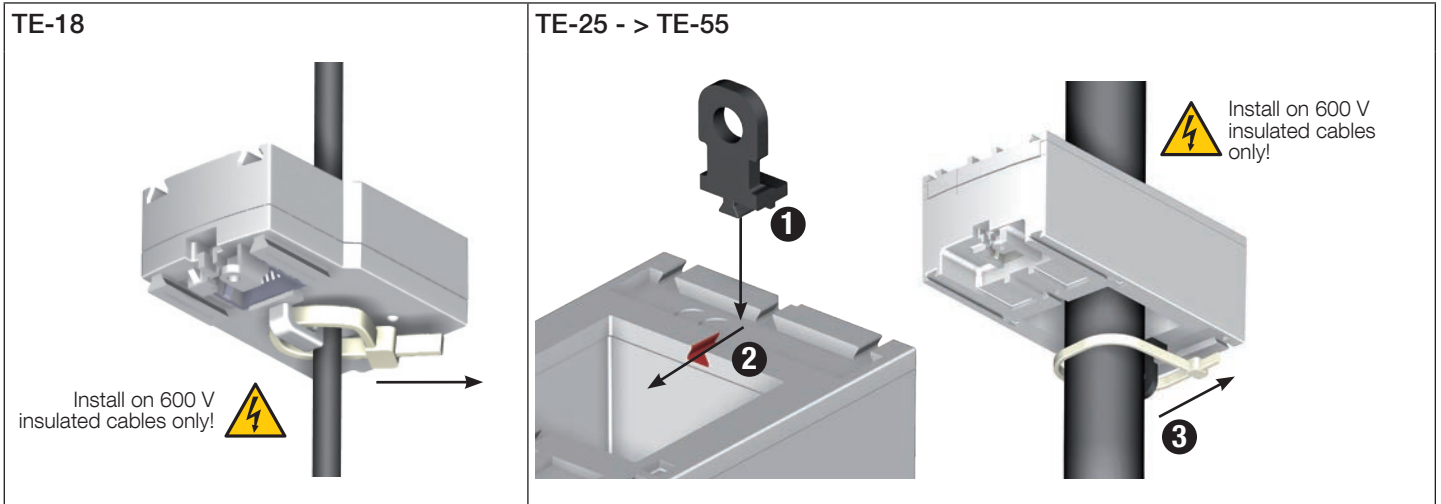

Note: Use the clamps to install the TE-90 sensors on a cable with clamping collar.



Do NOT clamp or pull out NON-INSULATED conductors carrying DANGEROUS VOLTAGE which could cause an electric shock, burn or arc flash.
Ref. IEC 61010-2-032

4.3.5. Bar mounting

TE-35 -> TE-55

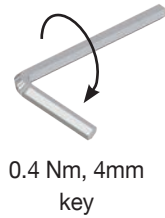
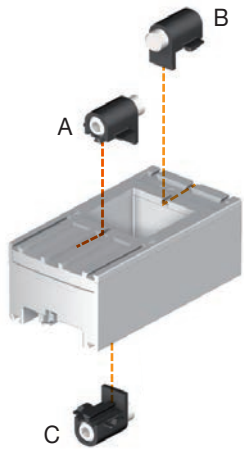

Installation options:
A+B, A+C

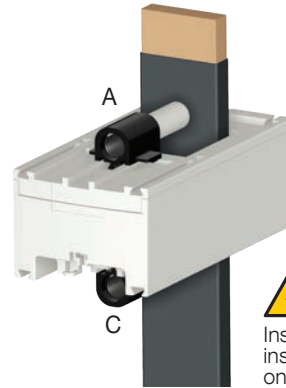
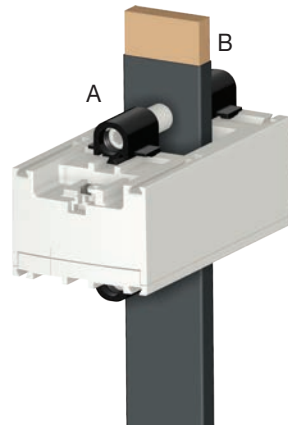

Install on 600 V insulated cables only!

TE-90

50x10 mm

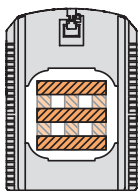

60x10 mm

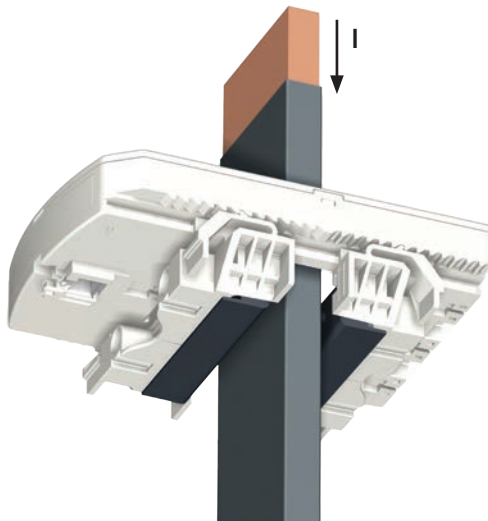
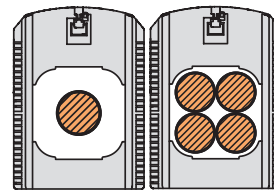
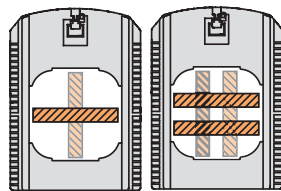

or

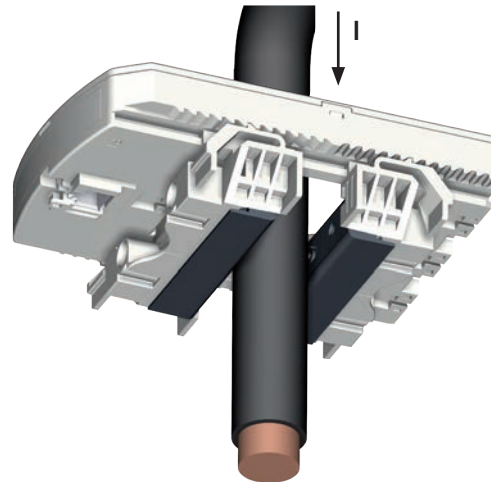

Install on 600 V insulated cables only!

1

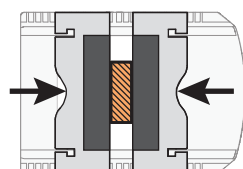

2

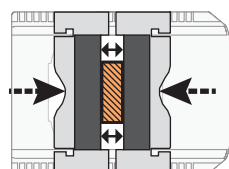

Tighten the jaws on both sides of the cable by applying pressure. The jaws must be perpendicular to the holding notches.



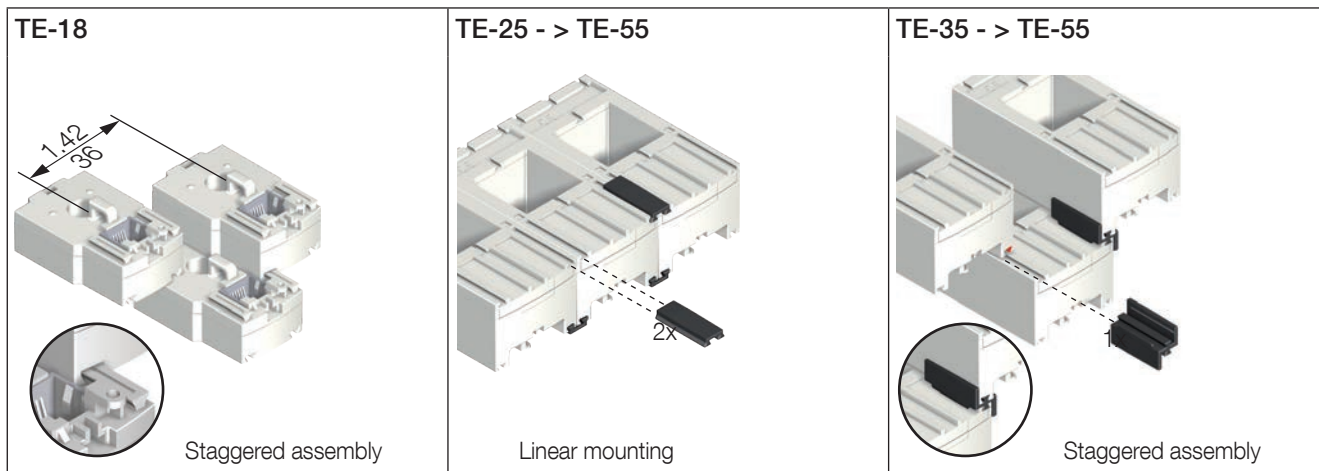

Do NOT clamp or pull out NON-INSULATED conductors carrying DANGEROUS VOLTAGE which could cause an electric shock, burn or arc flash.
Ref. IEC 61010-2-032

4.3.6. Sensors assembly

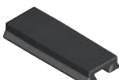

Mounting accessories for sensor combination:

		
Reference	Linear assembly	Staggered assembly
4829 0598	x30	

These accessories must be ordered separately.

4.3.7. Sealing accessories for sensors

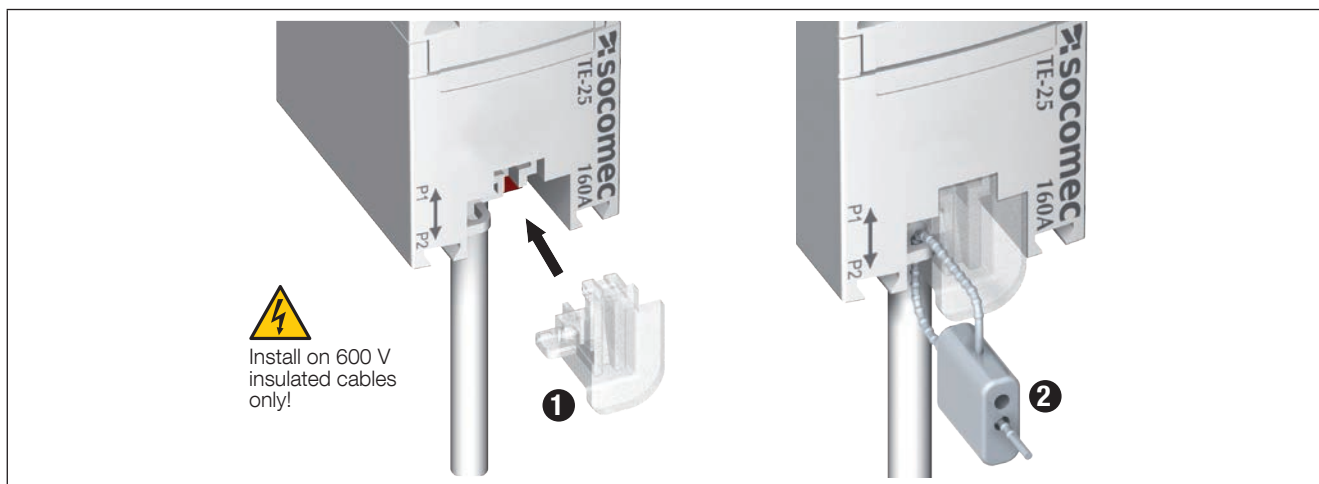

Reference	Sealing case for terminal
4829 0600	x20

These accessories must be ordered separately.

4.4. Installing TR split-core sensors

4.4.1. Cable mounting

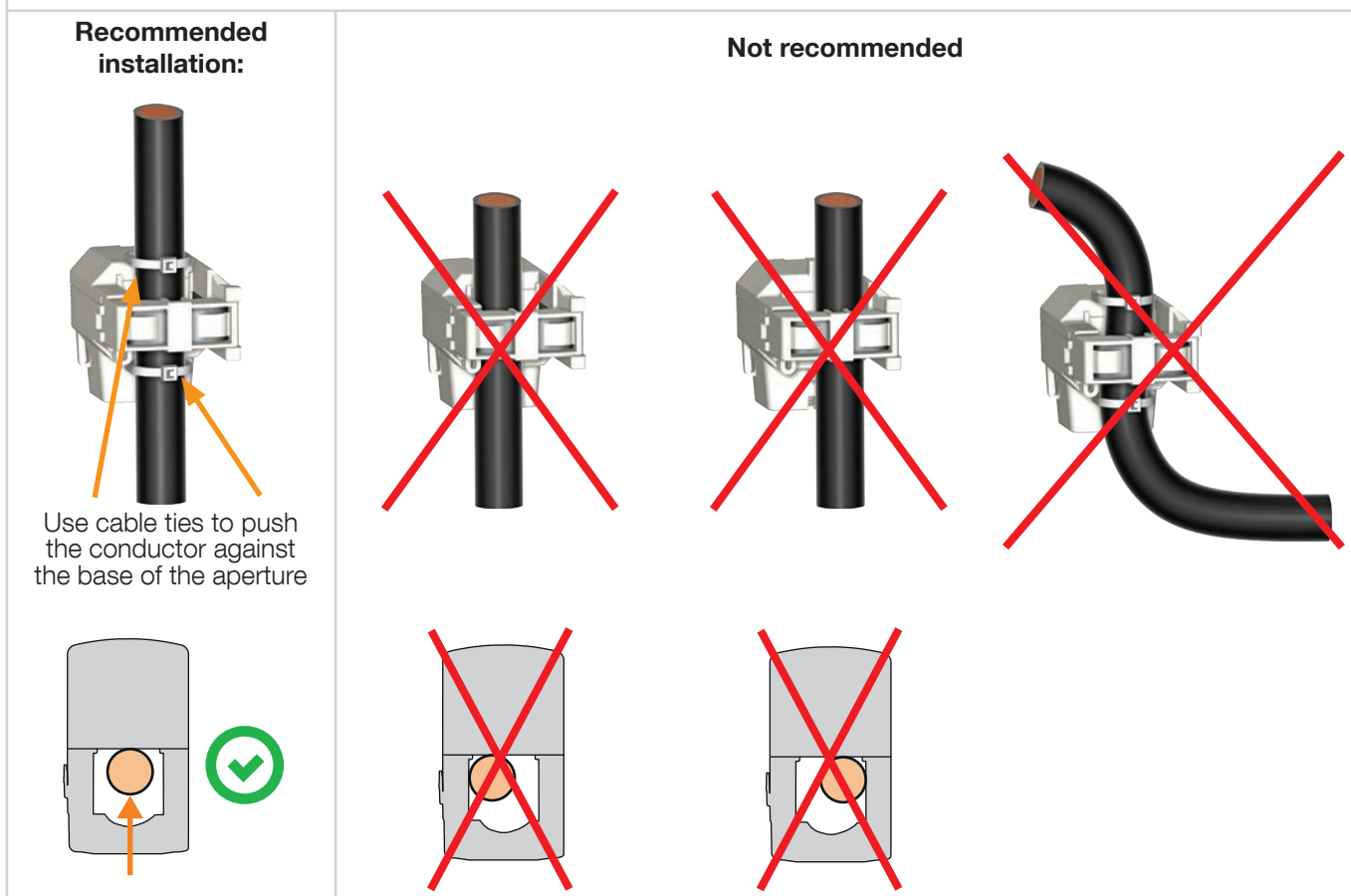
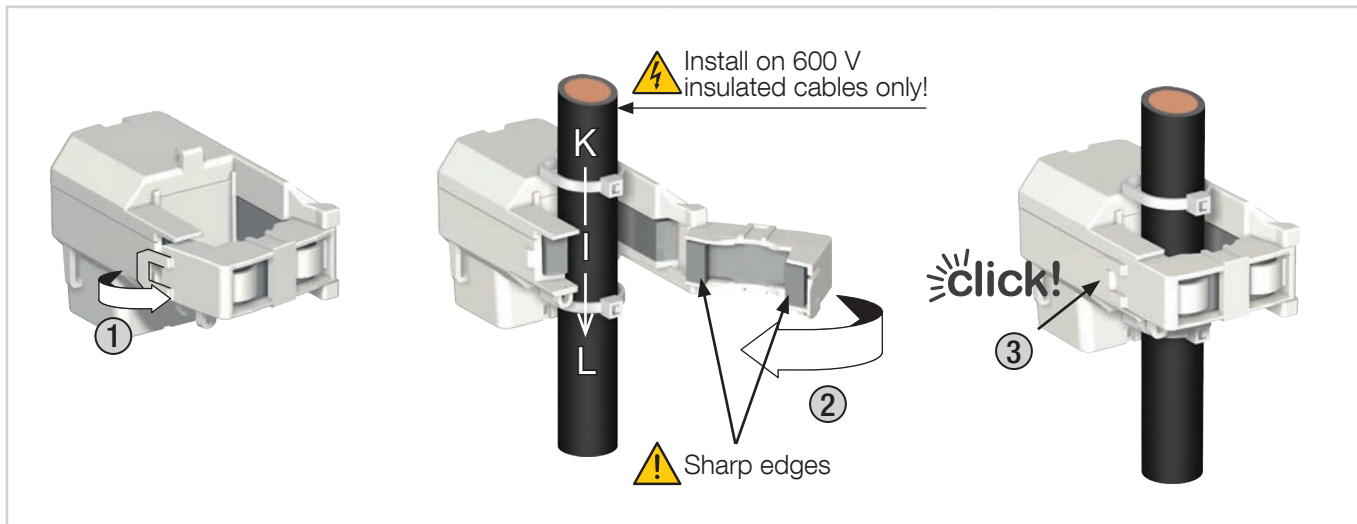

Do NOT clamp or pull out NON-INSULATED conductors carrying DANGEROUS VOLTAGE which could cause an electric shock, burn or arc flash. Ref. IEC 61010-2-032.



Before closing the TR /iTR sensor, check that the air gap is clean (no contamination or corrosion).

4.5. Installing TF Flexible current sensors

4.5.1. Cable or bus bar-mounting

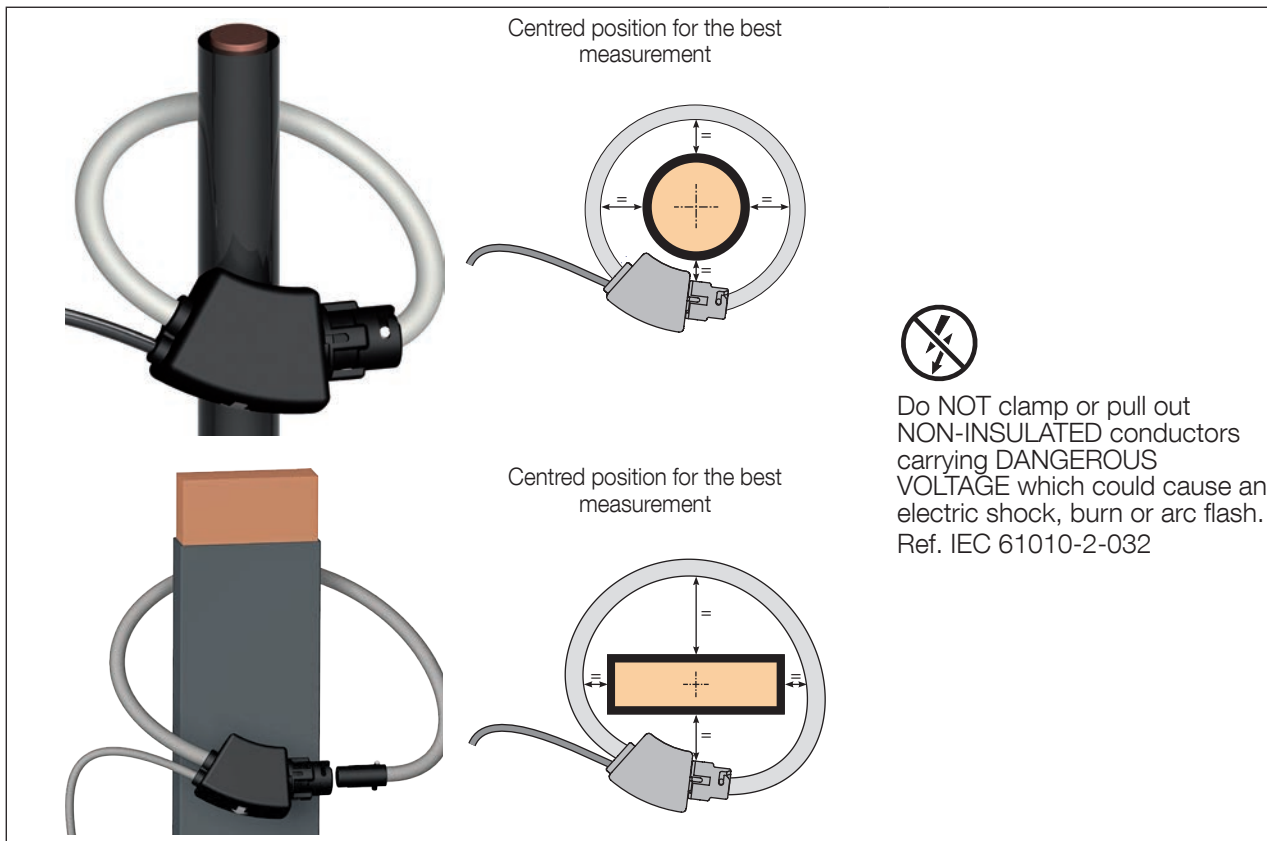
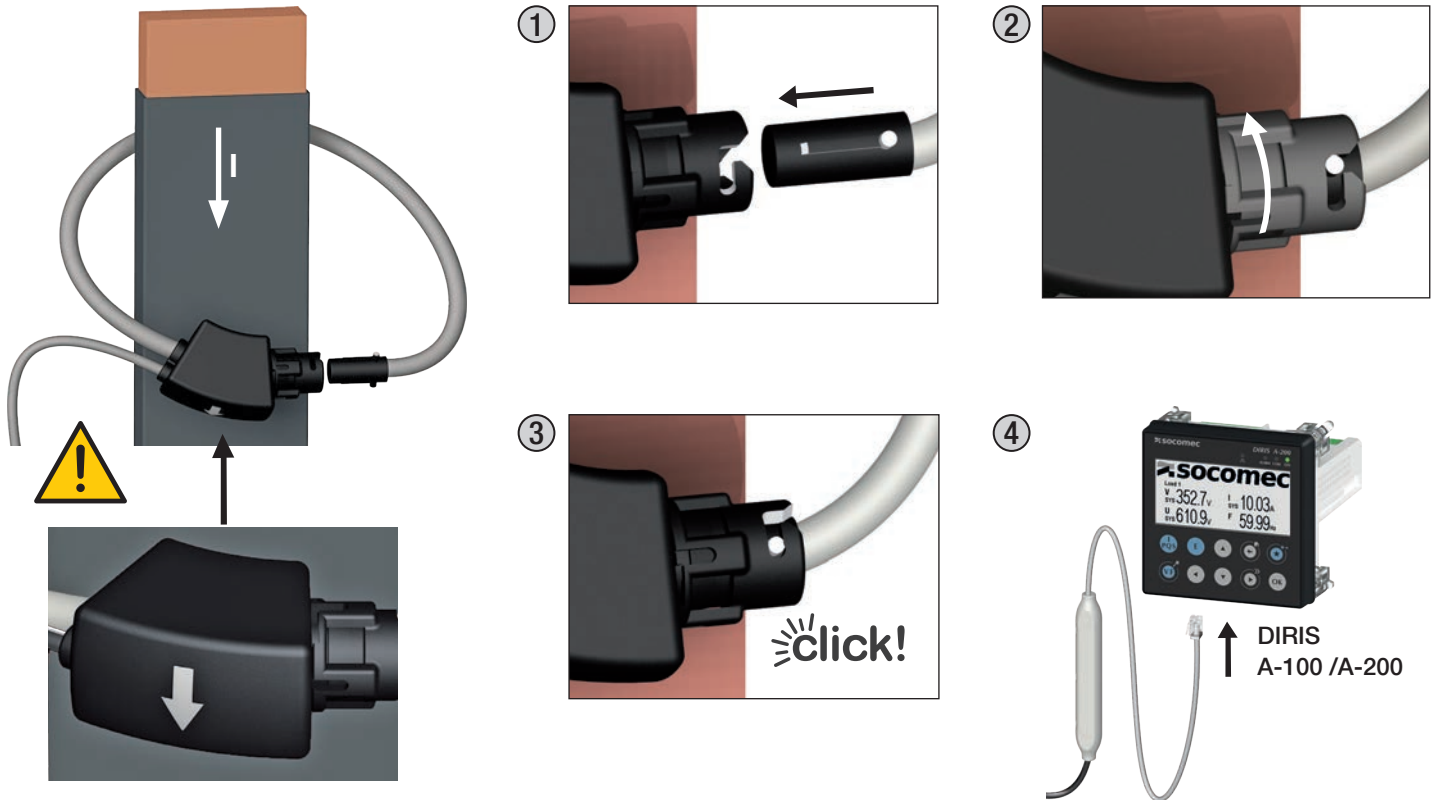

4.6. Installing Core-balanced toroids

4.6.1. Recommendations for the installation of core-balanced toroids around distribution cables

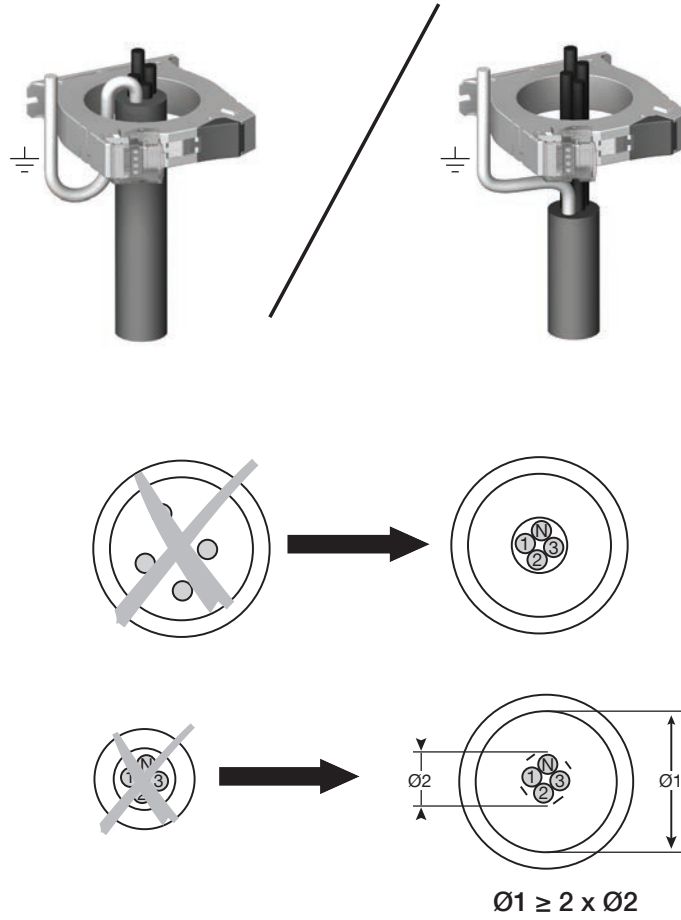

4.6.2. Centering accessory

Step 1: opening the accessory



Step 2: Clamping the wires and adapting the accessory to the wire section

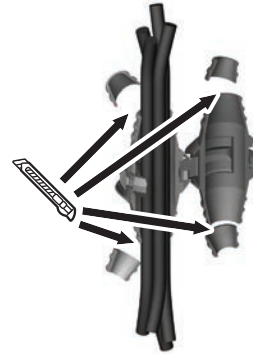

Step 3: closing the accessory

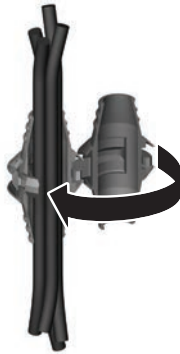

Step 4: clamping the tightening collars

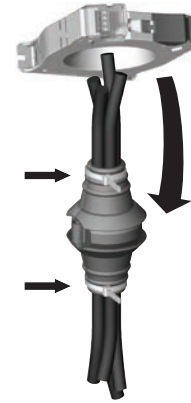

Step 5: Integration of the residual CT in the accessory



4.6.3. DIN rail mounting accessory compatible with Δ IC (\varnothing 15 – 120 mm)

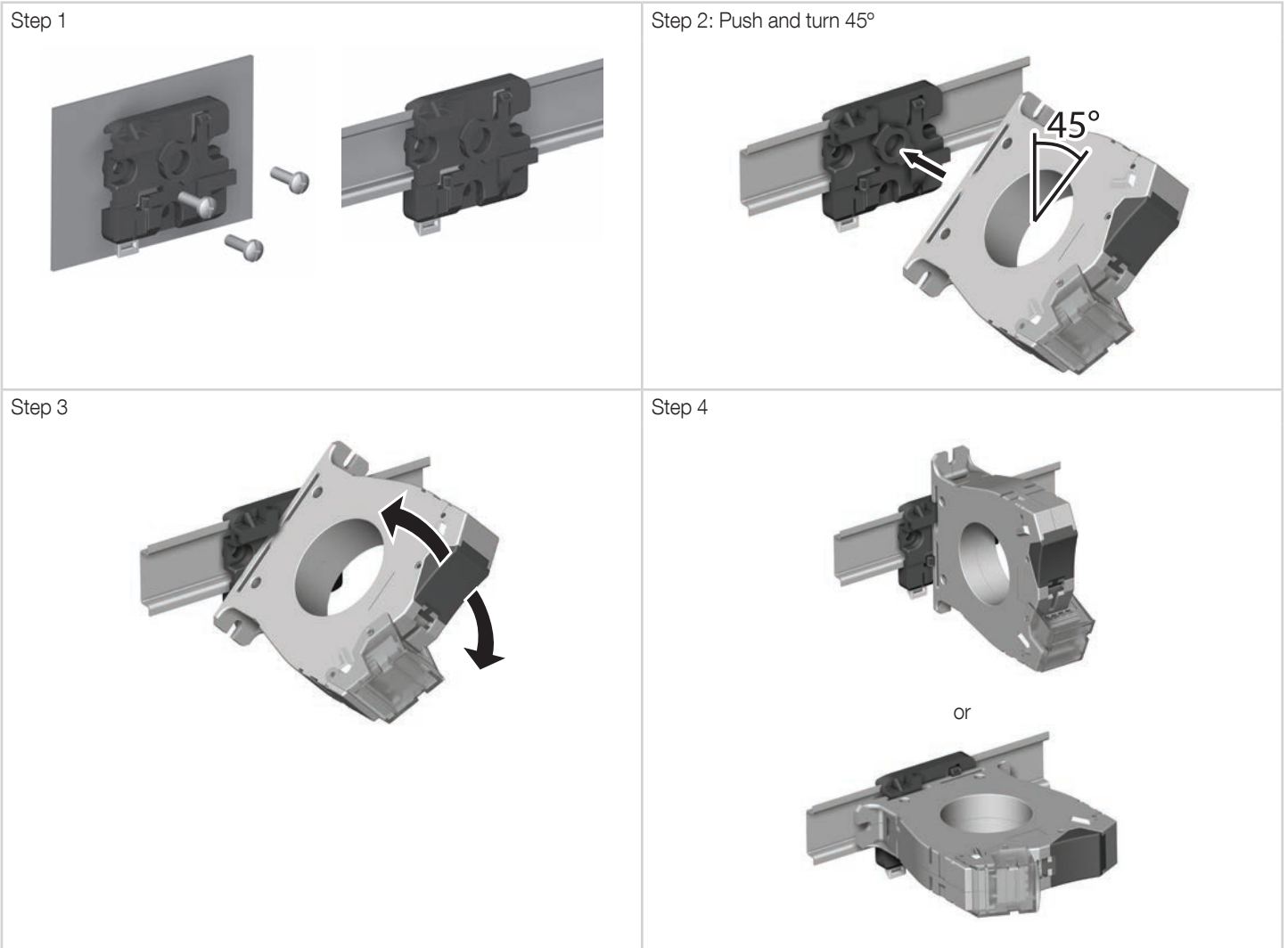

i Note: a DIN rail mounting accessory is provided with the Δ IC 8mm residual CT and the Δ IP-R range.

4.6.4. Mounting with metal bracket

Step 1: Mounting the accessory on back plate, by Pan Head thread-forming screws, metric thread, cruciform shape Z (Pozidriv).
Maximum torque:
- M5: 5.6 Nm
- M6: 9.6 Nm

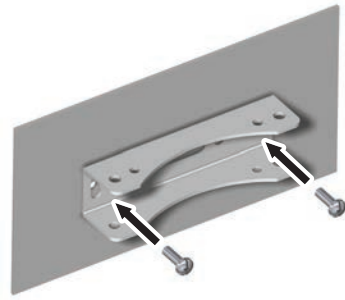

Step 2: mounting of the residual CT in the accessory with screws supplied

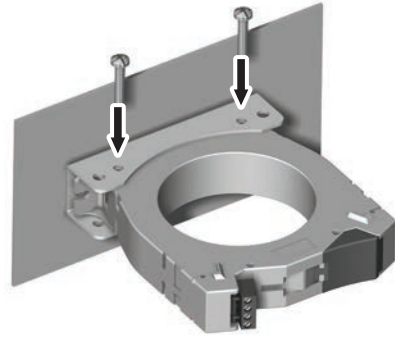

4.7. installing 333mV current transformers

Connecting the Current Transformer

- 1) **WARNING:** To reduce the risk of electric shock, always open or disconnect the circuit from the power-distribution system (or service) of the building before installing or servicing current transformers.
- 2) Point the SOURCE arrow toward the current source: the utility meter or the circuit breaker for branch circuits.

 Note: if the CT is mounted backwards, the measured power will be negative.

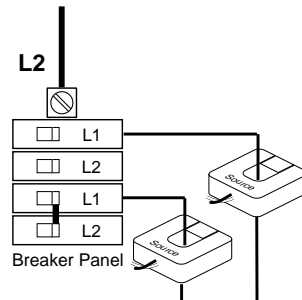

- 3) To open the CT, squeeze the knurled panels, then pull and rotate the top open.

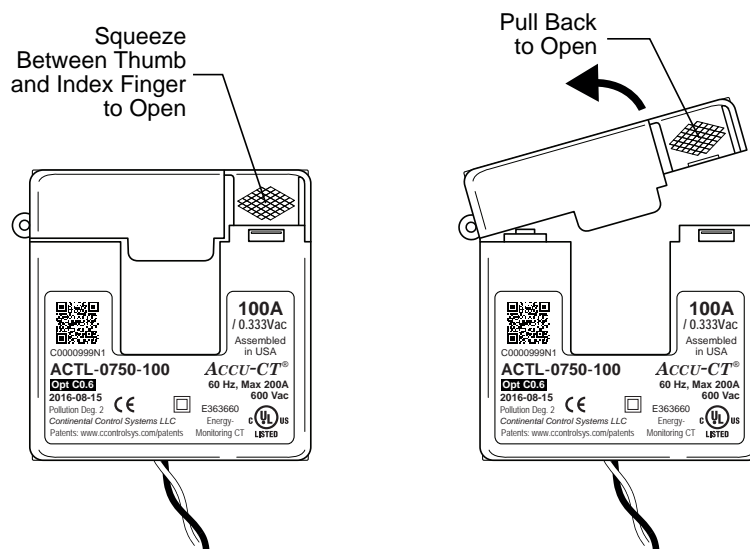

- 4) Make sure the mating surfaces are clean. Debris will increase the magnetic gap, decreasing accuracy.
- 5) Place the CT around the conductor and close the CT.

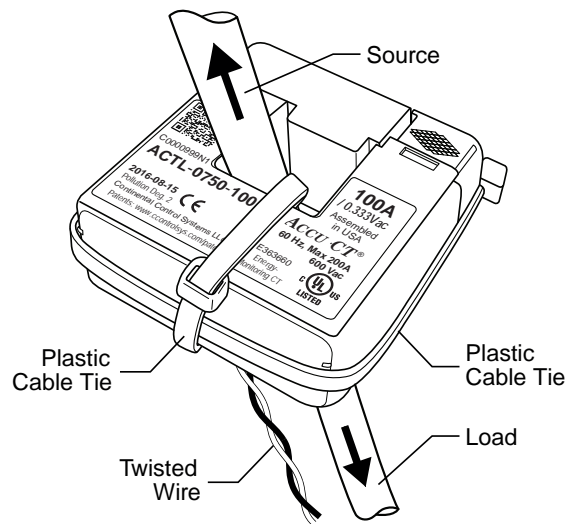

- 6) Optional: Secure the CT to the conductor with a cable tie.
- 7) Optional: For added security, wrap a cable tie around the outside of the CT.
- 8) Route the twisted black and white wires from the CT to the meter or monitoring device. Be sure to secure the CTs and route the lead wires so that they do not directly contact live terminals or busses.
- 9) Connect the white and black wires to the terminals on the meter or monitoring device.

-
- i** Note:
- If the white and black wires are reversed, the measured power will be negative.
 - The white wire should be aligned with the white dot on the label, and the black wire should be aligned with the black dot on the label.
 - Be careful to match the CT to the voltage phases being measured. Make sure the **ØA** CT is measuring the current on the **ØA** conductor, and the same for phases B and C. Use colored labels or tape to identify the wires.
-

4.8. installing solid-core TCL-B 333mV current transformers

- 1) **WARNING:** To reduce the risk of electric shock, always open or disconnect the circuit from the power-distribution system (or service) of the building before installing or servicing current transformers.
- 2) Disconnect the conductor to be monitored, so that the CT may be installed on the conductor.
- 3) Install the CT on the conductor with the labeled side of the CT (with “This side towards source”) facing toward the current source: the utility meter or the circuit breaker for branch circuits.

 Note: if the CT is mounted backwards, the measured power will be negative.

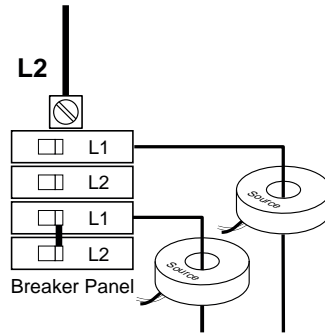

- 4) Reconnect the conductor to be monitored.
- 5) Optional: Secure the CT to the conductor with a cable tie.
- 6) Route the twisted black and white wires from the CT to the meter or monitoring device. Be sure to secure the CTs and route the lead wires so that they do not directly contact live terminals or busses.
- 7) Connect the white and black wires to the terminals on the meter or monitoring device.

 Note:

- If the white and black wires are reversed, the measured power will be negative.
- The white wire should be aligned with the white dot on the label, and the black wire should be aligned with the black dot on the label.
- Be careful to match the CT to the voltage phases being measured. Use colored labels or tape to identify the wires.

5. CONNECTION

5.1. DIRIS A-100 / A-200 connection

 Use SOCOMEC RJ-12 unshielded twisted pair (UTP) cables, stranded 24 AWG, 600V, -4 to +158°F (-20 to +70°C).

 Do not put USB or RJ45 connectors in contact with hazardous voltage.

 Do not connect RJ12 sensor cables into an RJ45 connector to avoid any risk of mechanical damage to this connector.

Supply
115-600 - L/L L/N 50-60Hz (7 VA)
1 A gG / 1 A class CC
Listed fuses for UL application



12VDC

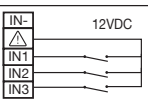

10-30VDC

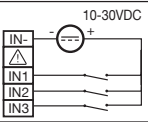



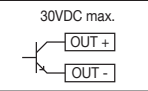

30VDC max.



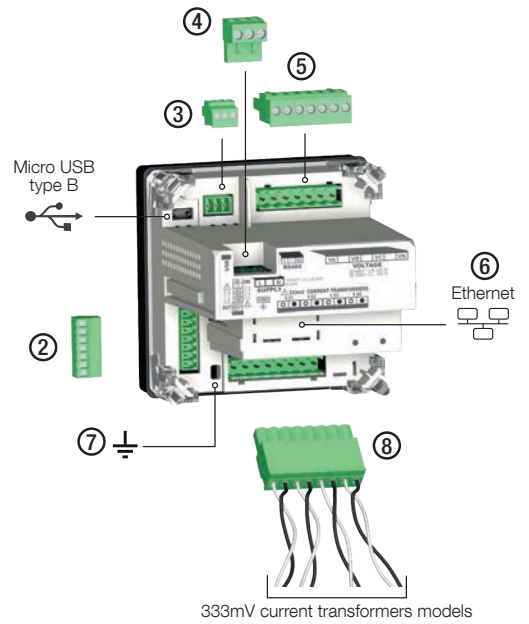
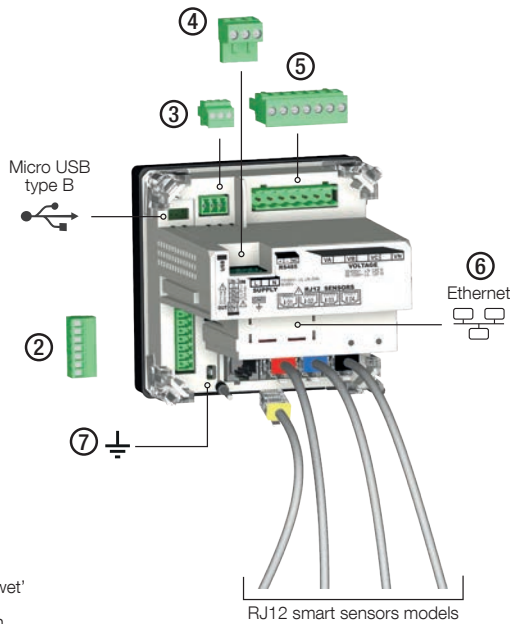

INPUTS:
If remote switch contact inputs are passive ('dry' contacts), please use terminal Δ for supplying one of the 3 inputs with 12V.
If remote switch contacts are active ('wet' contacts), please use terminal **IN-** and make sure the voltage applied is within the 10-30VDC range.

OUTPUT: optocoupler, apply max 30VDC and 20 mA of current.



		 *	
②	3x INPUT 	x = 6 - 7 mm 24-15 AWG 0,2 to 1,65 mm ²	0,147 lbf-in (0.2 Nm)
	12 to 24 VDC +/- 20% - 27 mA max. - SELV		
	1x OUTPUT 		
	30 VDC max - 20 mA max. - SELV		
③	RS485 MODBUS RTU SELV	x = 6 - 7 mm 24-15 AWG 0,2 to 1,65 mm ²	0,147 lbf-in (0.2 Nm)
④	SUPPLY 115-600 V~ L/L L/N (7 VA) 50-60 Hz	x = 7 mm 24-14 AWG 0,2 to 2 mm ²	0,486 lbf-in (0.66 Nm)
⑤	VA, VB, VC, and VN 50-600 V~ L/N CAT III 90-690 V~ L/L CAT III	x = 7 mm 24-13 AWG 0,2 to 2,6 mm ²	0,486 lbf-in (0.66 Nm)

		 *	
⑥	ETHERNET Modbus® TCP - BACnet® IP	-	-
⑦	GROUND	24-13 AWG 0,2 to 2,6 mm ²	0,486 lbf-in (0.66 Nm)
⑧	333 mV current transformers	x = 7 mm 28-12 AWG 0,08 to 3,31 mm ²	0,486 lbf-in (0.66 Nm)

SELV: Safety Extra Low Voltage.
(* Use Copper conductors only.)

Description of the terminals:

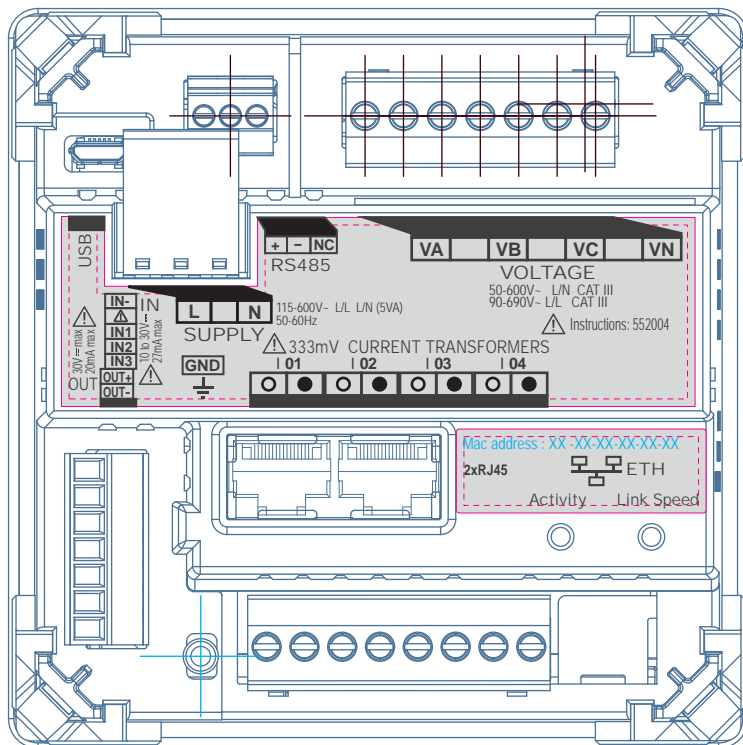
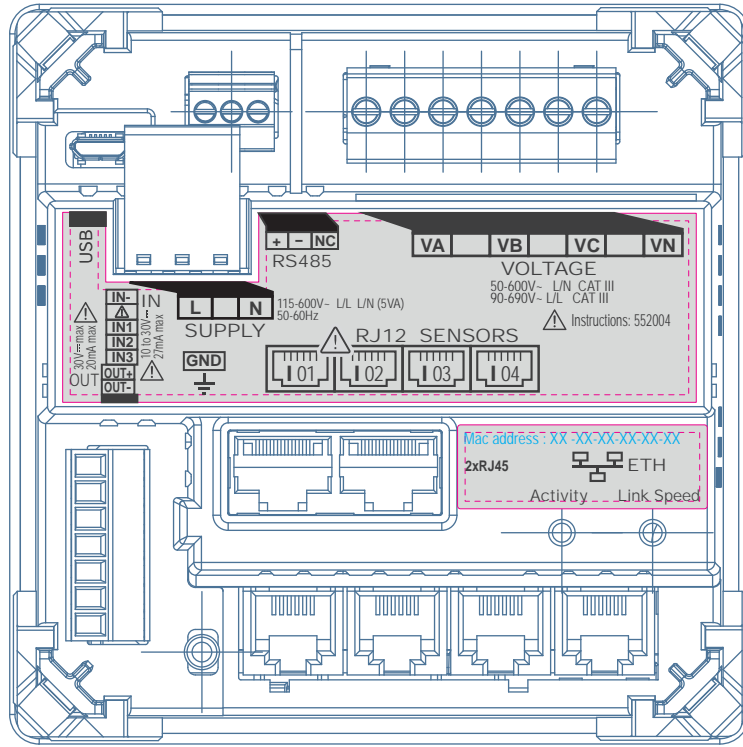

5.2. Connection to the electrical network and to the loads

The DIRIS A-100 / A-200 can be used on single-phase, two-phases, three-phases or three-phases with a high leg networks.

Warning, in case of connection to a high leg network, please make sure the high leg conductor is a result of phase A and B, as depicted on the picture below :

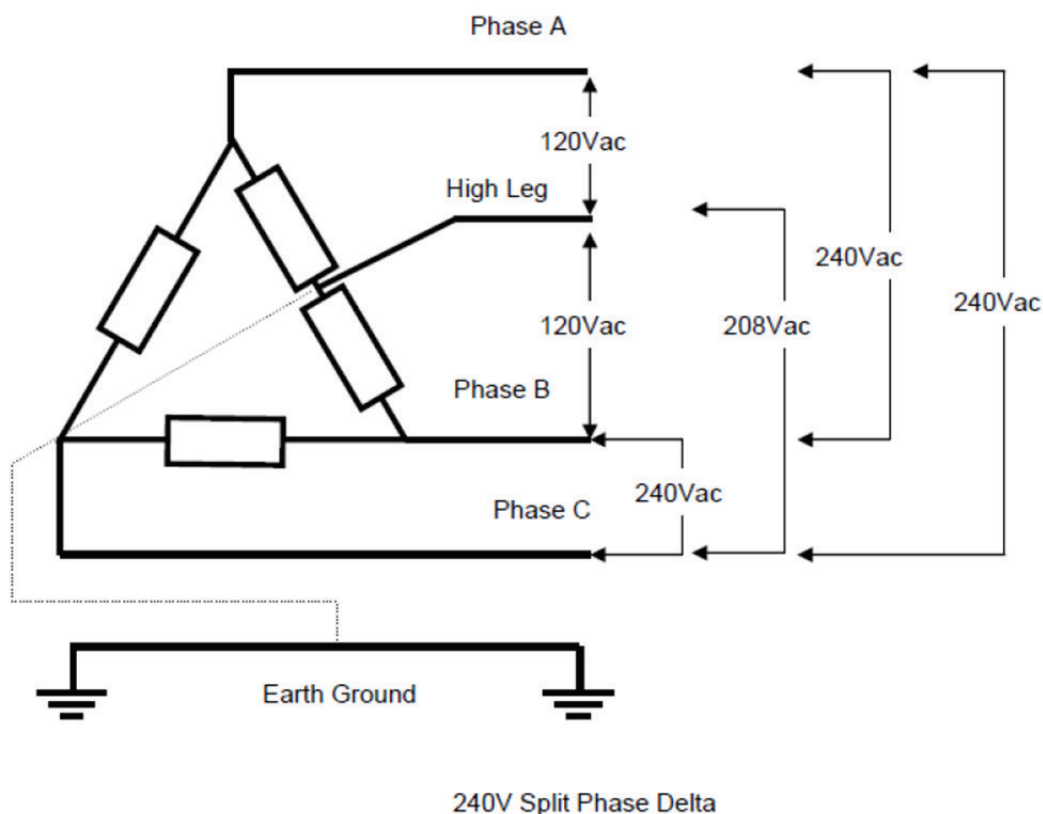

Different loads will then be measured simultaneously, allowing great flexibility in terms of where it is fitted in the installation. The loads are measured using several types of sensor (closed, split-core, flexible) selected depending on the application. The link between the DIRIS B and its associated sensors is performed using cables with RJ12 connectors. These connectors enable rapid, trouble-free installation, in complete safety, with no risk of the connector being inverted, and also offers automatic detection of the connected sensors.

In addition, the DIRIS A is able to identify the majority of load types to be measured: single-phase, three-phase with or without neutral using 1, 2, 3 or 4 sensors for balanced or unbalanced loads. Several loads can be measured simultaneously.

The overall accuracy of the DIRIS A + RJ12 sensors measurement chain is guaranteed. To guarantee this accuracy, SOCOMEC cables must be used for the RJ12 current sensors.

5.2.1. Configurable loads based on the network type

The table below summarises the load that it is possible to configure depending on the type of network at the installation.

Network type	Configurable load
Single-Phase, Two-Wire, Line-to-Neutral	1P+N - 1CT
Single-Phase, Two-Wire, Line-to-Line	2P - 1CT
Single-Phase, Three-Wire (Split-Phase)	2P+N - 2CT
Three-Phase, Three-Wire Delta*	3P - 3CT / 3P - 2CT / 3P - 1CT
Three-Phase, Four-Wire Wye	3P+N - 3CT / 3P+N - 1CT / 3P+N - 4CT / 3P+High-leg - 3CT

(*) Note: Single-phase loads cannot exist on a 3P network.

5.2.2. Description of the main network and load combinations

Legend:

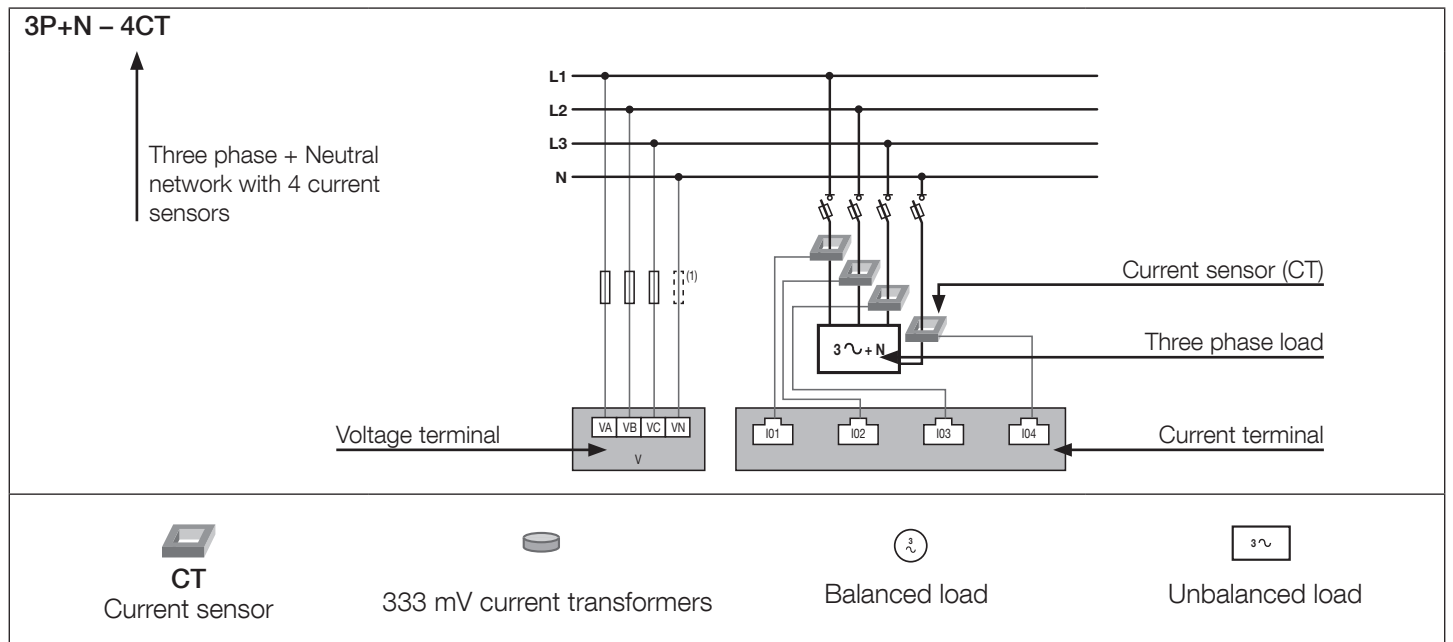

5.2.3. Line voltage and load connections for RJ12 smart sensors models

Each current input is individual; see below for some connection examples:

<p>Three-Phase, Four-Wire Wye 3P+N – 4CT (1 three-phase load + measured neutral)</p>	<p>Three-Phase, Four-Wire Wye 3P+N – 3CT & 3P – 1CT (1 unbalanced three-phase load + calculated Neutral + 1 three-phase balanced load)</p>	<p>Single-Phase, Three-Wire (Split-Phase) 2P+N – 2CT (x2) (2 two-phase loads)</p>
<p>Three-Phase, Four-Wire Wye 3P+N – 3CT & 1P+N – 1CT (1 three-phase load + calculated Neutral + 1 single-phase load)</p>	<p>Three-Phase, Three-Wire Delta 3P – 3CT & 3P – 1CT (1 unbalanced three-phase load + 1 three-phase balanced load)</p>	<p>Single-Phase, Two-Wire, Line-to-Neutral 1P+N – 1CT (x4) (4 single-phase loads)</p>
<p>Single-Phase, Two-Wire, Line-to-Line 2P – 1CT (x4) (4 two-phase loads)</p>	<p>Three-Phase, Three-Wire Delta 3P – 1CT (x4) (4 three-phase balanced loads)</p>	<p>Three-Phase, Three-Wire Delta 3P – 2CT (x2) (2 three-phase loads*)</p> <p>* The solution with 2 CTs with the 2nd phase current calculated via vectoral summation, results in an 0.5% reduction in phase accuracy.</p>
<p>Three-Phase Four-Wire Delta (High Leg) 3P+N – 3CT (1 three-phase load)</p>	<p>Three-Phase, Four-Wire Wye 3P+N – 3CT (1 three-phase load with RCM* (IΔ))</p> <p>* only for DIRIS A-200 with RJ12 smart sensors ref. 48250602 and 48250604.</p>	<p> Fuse: 1 A gG / 1 A class CC Listed fuses for UL application</p> <p> TE / TR / iTR / TF sensors</p> <p> Balanced load</p> <p> Unbalanced load</p> <p>(1) For connection to IT system earthing, adapt the protection in accordance with the installation standards currently in force.</p>

Notes relating to connections:

The **Easy Config System software** can also be used to select numerous other configuration variants for the types of loads and associated network voltages.

3P – 2CT: this connection reduces the accuracy of the phases, the current for which is deducted by vectorial calculation, by 0.5%.

3P – 1CT: this connection requires a three-phase network that is perfectly balanced.

Connection of the functional earth

It is recommended that the functional earth is connected to guarantee optimum measuring accuracy and better emissivity/immunity for the electromagnetic compatibility (class B in conducted emission). Earth must not be used in a neutral IT system.

5.2.4. Line voltage and load connections for 333mV current transformers models

Each current input is independent: see below for some connection examples:

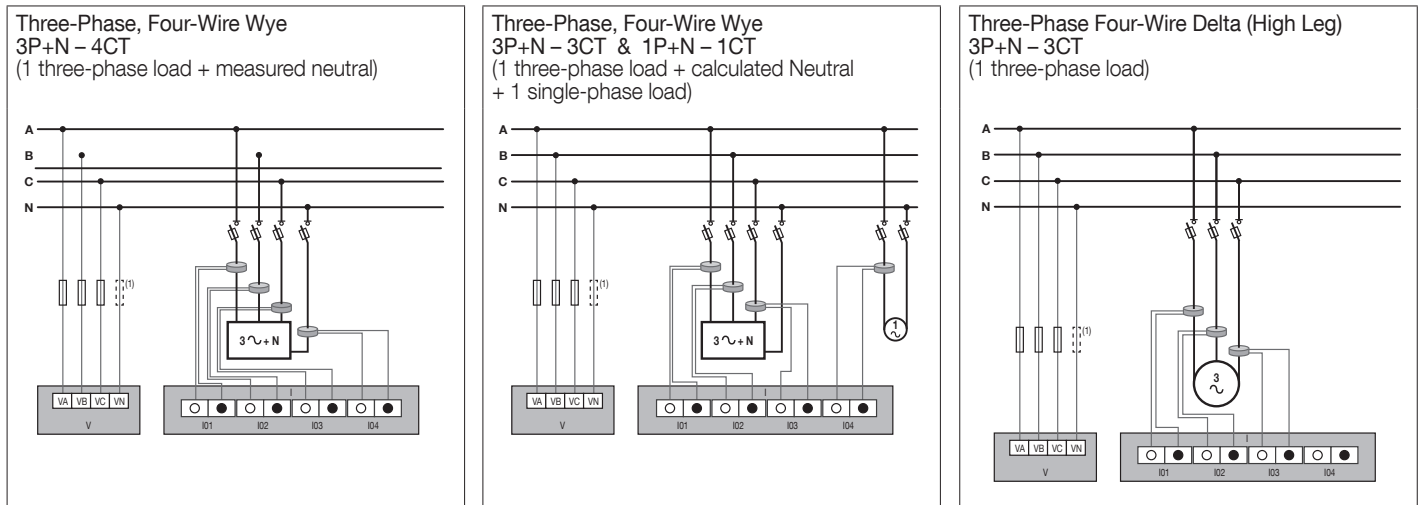

(1) For connection to IT system earthing, adapt the protection in accordance with the installation standards currently in force.

 Fuse: 1 A gG / 1 A class CC
Listed fuses for UL application

 333 mV current transformers

 Balanced load

 Unbalanced load

6. COMMUNICATION

6.1. Modbus General information

The Modbus RTU available on the DIRIS A-100 / A-200 communicates via an RS485 series link (2 or 3 wires) which is used to operate products from a PC or an API.

In a standard configuration, an RS485 connection is used to connect 32 products to a PC or a controller over 1200 meters.

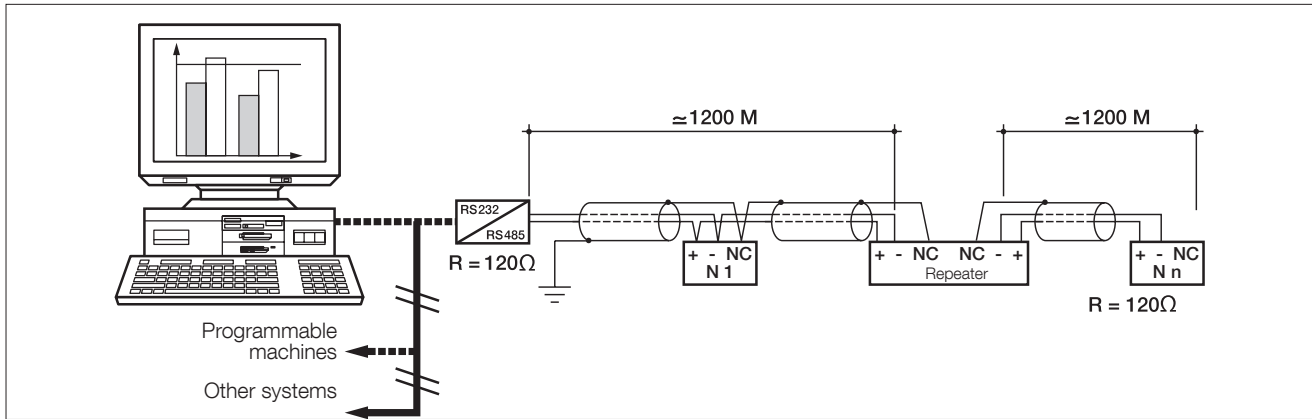
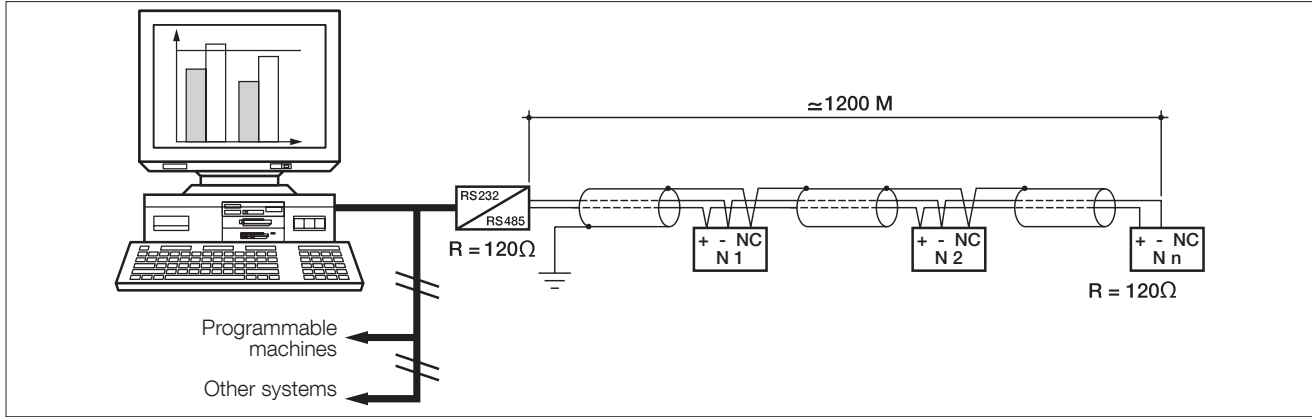

6.2. RS485 rules

A LIYCY shielded twisted pair must be used. We recommend using a shielded twisted pair with a general LIYCY-CY shielding in an environment where there is interference or in a very long network with a number of products.

If the distance of 1200 m is exceeded and/or the number of products is greater than 32, a repeater must be added to enable additional products to be connected.

A 120 Ohm resistor must be fixed at both ends of the connection.

6.3. Modbus and BACnet communication tables

The Modbus and BACnet communication tables and the associated explanations are available on the DIRIS A-100 / A-200 documentation page on the website at the following address:



7. CONFIGURATION

The device can be configured directly from the DIRIS A-100 / A-200 screen or with the Easy Config System software. The following paragraphs describe configuration with Easy Config System for different types of communication architecture and several types of connected SOCOMEC products.

7.1. Connection modes for remote configuration

Direct USB connection between device and computer

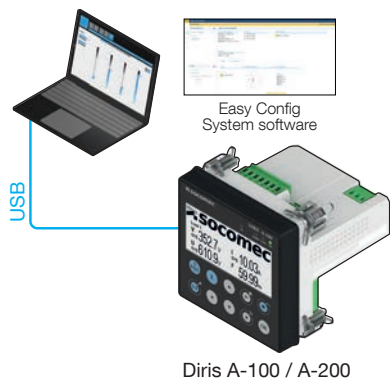

Ethernet connection directly between device and computer or through local network with a switch or router

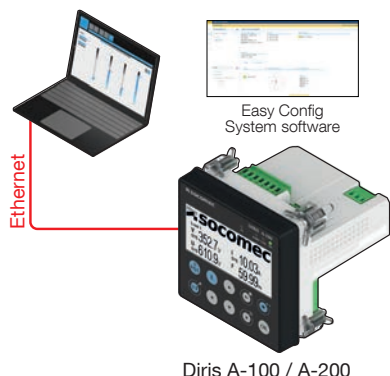

Display



7.2. Configuration via Easy Config System

The Easy Config System software can be downloaded from the Socomec website at the following link:

https://www.socomec.com/easy-config-system_en.html

The Configuration of the DIRIS A-100 / A-200 can be done from the Easy Config System software, by connecting a computer to the DIRIS A-200 either via USB or via Ethernet.

7.2.1. USB connection mode

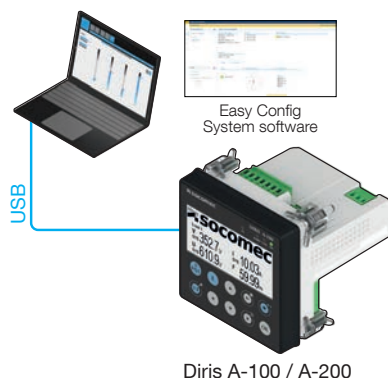

- Open Easy Config System.
- Connect a USB cable between the DIRIS Digiware A-100 / A-200 and a computer.
- Log in as User or Admin. Admin default password is "Admin".
- Click on "New Configuration", enter a name and icon.
- Click on the newly created configuration.
- Click on "USB mode" on the right top corner to connect to the A-100 / A-200 and access configuration menus.
- Click on the "Binocular" icon on the left side bar.
- Under the "Organisation" part, select the A-100 / A-200.
- Click on "Dashboard" to visualise general information about the device:

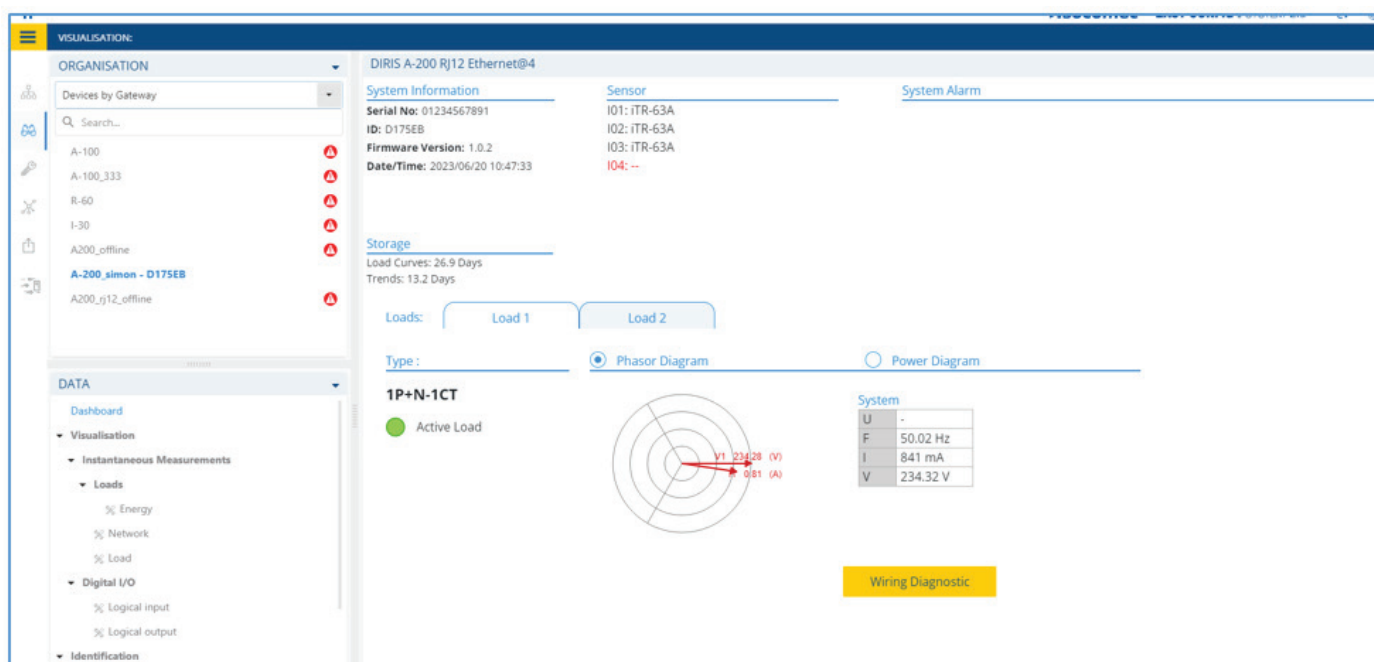

7.2.2. Ethernet connection mode

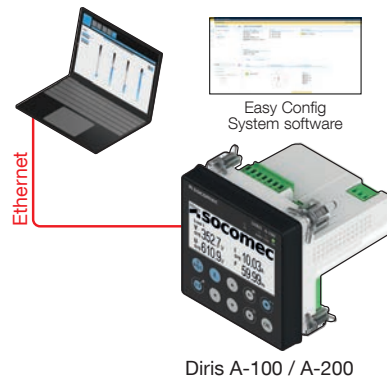

- Open Easy Config System.
- Log in as User or Admin. Admin default password is “Admin”.
- Click on “New configuration”, enter a name and icon.
- Click on the newly created configuration.
- Click on the “+” icon to manually add the A-200 to the topology, by selecting the product, entering the IP address, Modbus address. To be able to communicate with the A-200, your computer must be in the same network as the A-200.
- Click on the “Binocular” icon on the left side bar.
- In the “Organisation” part, select the A-200.
- In the “Data” part, click on “Dashboard” to visualise general information about the display.

Measurement

- The uplink period determines the integration period of load curves and trends of average values.
- Electrical network: configure the electrical network type (three-phase, with or without neutral, etc.), the nominal voltage and frequency, and the phase rotation. In case of Voltage transformer it is also possible to configure it.
- Load:
 - Activate: activate a load and name it. (you can configure up to 4 loads depending on the configuration and amount of current transformers connected).
You can also activate RCM for each load. This will use one CT input which has to be populated with a core balanced toroid. In this case in addition to measuring the load current, the DIRIS A-200 will also measure residual current.
 - Type: enter the load type (single-phase, three-phase with or without neutral etc.), and the nominal current.
 - Phase association to current inputs: indication only, shows the association of RJ12 current inputs to phase conductors.
- Current sensors: for each current input (I01 - I04), you can configure the following fields:
 - Rating: the rating of current sensors is automatically detected
 - CT way (for current sensors only): positive (P1 - > P2) or negative (P2 -> P1).
 - Associated voltage: voltage associated to the current measurement.
- Calculations:
 - Integration periods: enter the integration period of instantaneous values.
 - THD: you can configure the THD calculation method
 - Other: you can configure the calculation method for powers and energies (vector or arithmetic) and the powerfactor convention.

Display

- Screen configuration: configure everything related to the screen of the device
 - Display flashing on active alarm: if activated, screen will blink a few time upon the selected type of alarm which is active.

Communication

- Modbus
 - Modbus address: unit slave ID from 1 to 247
 - Baud rate: communication speed up to 115.2k bauds
 - Stop bit
 - Parity
- IP Configuration
 - Ethernet auto-detection (SSDP): if enabled, device can be automatically detected on the TCP/IP network through SSDP protocol
- BACNet IP

Digital I/O

- Digital Input:
 - Mode: configure the digital input mode.
 - . Binary state & Pulse meter.
 - . Synch.signal.
 - Type: normally open or normally closed.
 - Name: you can name the digital input. The name will be shown on the A-100 / A-200 and on WEBVIEW.
 - Pulse meter: if the digital input “Mode” is set to “Bin. State & Pulse meter”, you must enable the “Pulse Meter” function if you want collect pulses from utility meters.
- Digital Output: the digital output can be used for alarm reporting purposes.
 - Type: normally open or normally closed.
 - Name: you can name the digital output. The name will be shown on the A-100/A-200 and on WEBVIEW.

Date/time

- Date/time: to manually synchronise the date/time of the DIRIS A-100 / A-200 with the computer's date and time.
- SNTP server: only available with A-200 ethernet: you can configure an SNTP server on the network to automatically retrieve date/time from it.
- Week numbering: choose the standard for numbering weeks. This is used in case alarms on energy consumptions are configured. If consumption rises above a threshold configured upon a one week period.

Monitoring

- Demand profiles.
 - Integration period: the integration period of Demand profiles is displayed
 - Metrological LED: choose the energy type and the load associated to the metrological pulse LED on the front of the DIRIS A-100/A-200.
- Load shedding: It allows to trigger an output command if the predictive power value exceeds a pre-determined threshold.
 - State: enable or disable the Load shedding function.
 - Output: choose the digital output associated to the load shedding function.
 - Associated predictive power: choose the associated predictive power.
 - Threshold: enter the threshold from which the load shedding function will be triggered.
- Protection
 - Protective device: select the protective device type (breaker, fusible switch, switch, fuse.) This only works by using iTR sensors that have Virtual monitor technology to automatically detect protection status (open / close / trip / ...)
 - Sources: select the source for the position and trip information. When iTR sensors are used, the VirtualMonitor technology is used.
 - Thresholds: used to differentiate between no-load, on-load and overload manual openings and trips.

Alarms

- Measurement alarm: you can configure up to 8 measurement alarms each based on high and low thresholds.
- Protection alarm: you can configure up to 6 protection alarms to alert in case the protective device is opened, has tripped or is defective.
- Logical alarm: you can configure up to 4 logical alarms to alert when there is a change of digital input status.
- Combination alarm: you can combine several existing alarms together to trigger an alarm which is a combination of others with Boolean operations.
- Overload alarm: triggers upon load overcurrent
- EN50160 events: setup voltage swells, dips and interruption characteristics
- System alarm: you can configure up to 4 system alarms to alert if there is a commissioning error.

Waveforms

- Waveform settings: when an EN50160 or overcurrent event is triggered you have the ability to log the associated waveforms during the event to understand the cause of it
 - Capture ratio post trig event: percentage from 0 to 100% that determines the amount of waveform captured data that will happen after the event started. If set to 50%, half of the data will be before the event started (buffer) and half of the data will be after the event started.
 - Capture subsampling: number of data used per point to draw the waveforms. The greater the value, the less precise will be the waveforms, but the duration of the capture will be greater. Subsampling means taking less points per periods.
 - Swell/sag/interruption/overcurrent/digital input: select which criteria should trigger a set of waveforms capture. Note: Digital input means you can manually trigger a capture by closing an input of your choice
 - Capture on powerfail: only works on A-200. In the event of an interruption of voltage, the device has an internal capacitor that allows it to capture the waveforms of the interruption event even though the product is not supplied anymore, before shutting down.

Emails (SMTP)

- SMTP settings: if set to yes, configure the address and details of an SMTP server that will send e-mails when alarms are triggered
- Send test email: allows testing if your SMTP server setup is working properly by sending an test e-mail.

Tariff settings

- Tariff Management
 - Number of tariffs: set how many tariffs are managed by the product, if you set a time of use configuration, do not change this.
 - Source: which entity manages the change of tariff.
 - . Communication: sending an Modbus write command to change tariff
 - . Input: change tariff by switching an input state
 - . Tariff received by internal calendar: if time of use is setup, this setting will automatically be configured to this value. Alternatively you can setup to this, if a calendar for managing tariffs is sent from an external gateway (like DIRIS DIGIWARE D-70 for instance)

Time of use settings

For global explanation on how to use to Time of use feature please see Annex III: Time of use configuration. You have to use either the wizard time of use on the display of the device, or the time of use dashboard within easy config system.

- Demand response: in case it is enabled, chose any of the tariffs configured. This tariff will override any ongoing tariff whenever the configured input is triggered. The override of the tariffs will stay active until the next change of tariff by the time of use calendar.

Commands

- Reset: to reboot the DIRIS A-100 / A-200, reset alarm logs, Min/Max values, partial meters or restore the device to its factory default settings.

7.3. Configuration from the display

7.3.1. Navigation



To access navigation, press "OK" to view the different menus available:

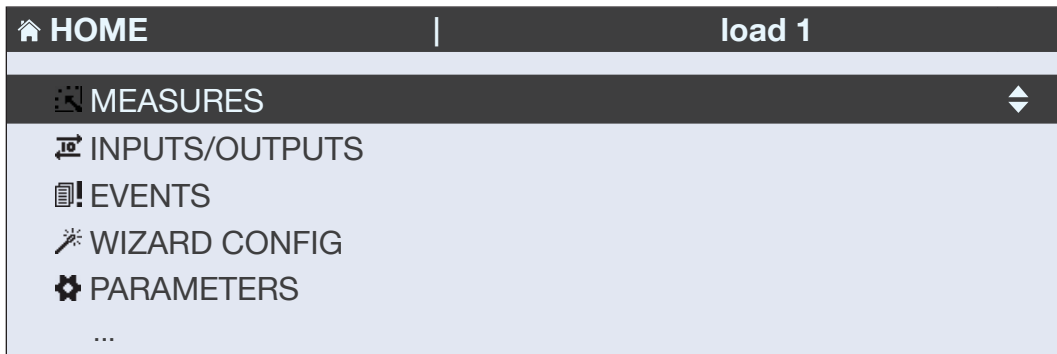

7.3.2. Description of the Wizard

The wizard allows very fast configuration of the main parameters of the DIRIS A-100 / A-200:

The wizard is launched automatically at the first use and on demand for later uses. It is also possible to access the wizard by holding down the  button or via the menu on the screen using the "UP ARROW" and "DOWN ARROW" navigation buttons and confirming with "OK".

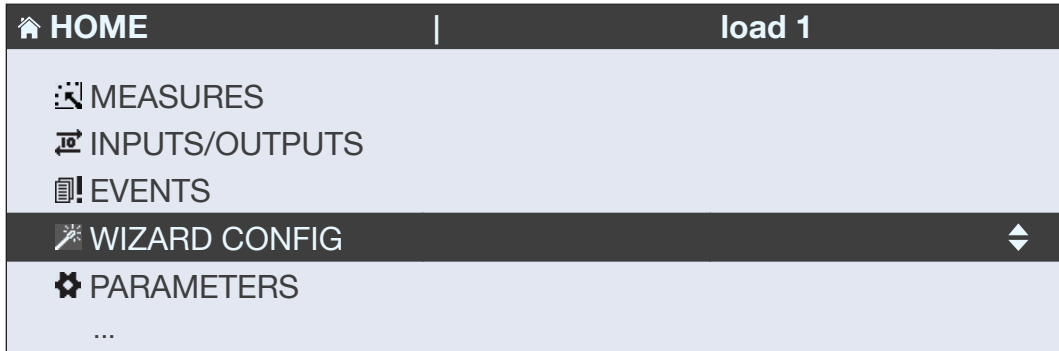

The wizard begins by choosing the language and allows configuration of the main parameters of the DIRIS A-100 / A-200 by means of a series of screens:

- Date/time
- Load type
- Integration period
- Communication

The Wizard can be launched using 2 modes chosen by the user:

- "SMART CONFIG" mode: The type of electrical network and the load are detected automatically
- "MANUAL CONFIG" mode: the user himself configures the parameters of the electrical network and of the load

 Note: the default access code for configuration is 0100.

7.3.3. Complete configuration

To access the complete configuration of the product and in particular the configuration of the alarms and of the additional parameters not covered by the Wizard, select the "PARAMETERS" menu:

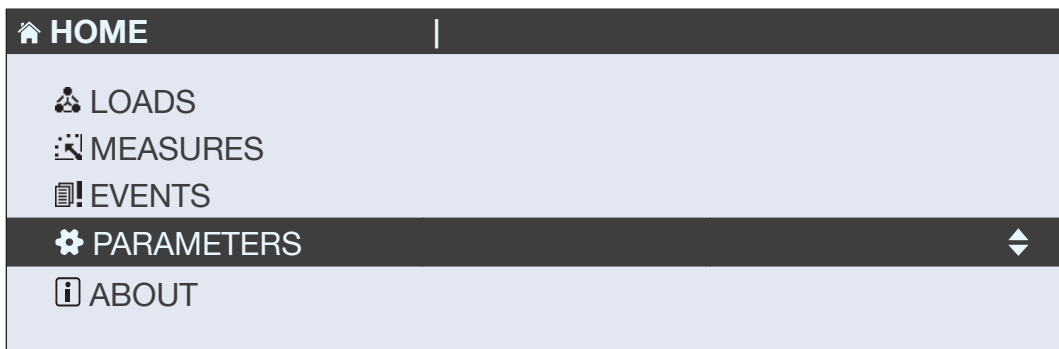

Enter the password "100" using the arrow pad (4 arrow keys) and confirm with "OK":

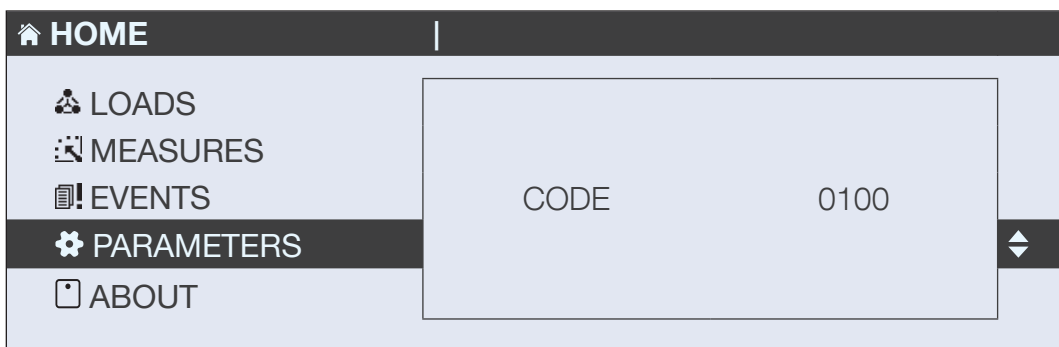

This gives access to the whole configuration of the DIRIS A-100 / A-200:

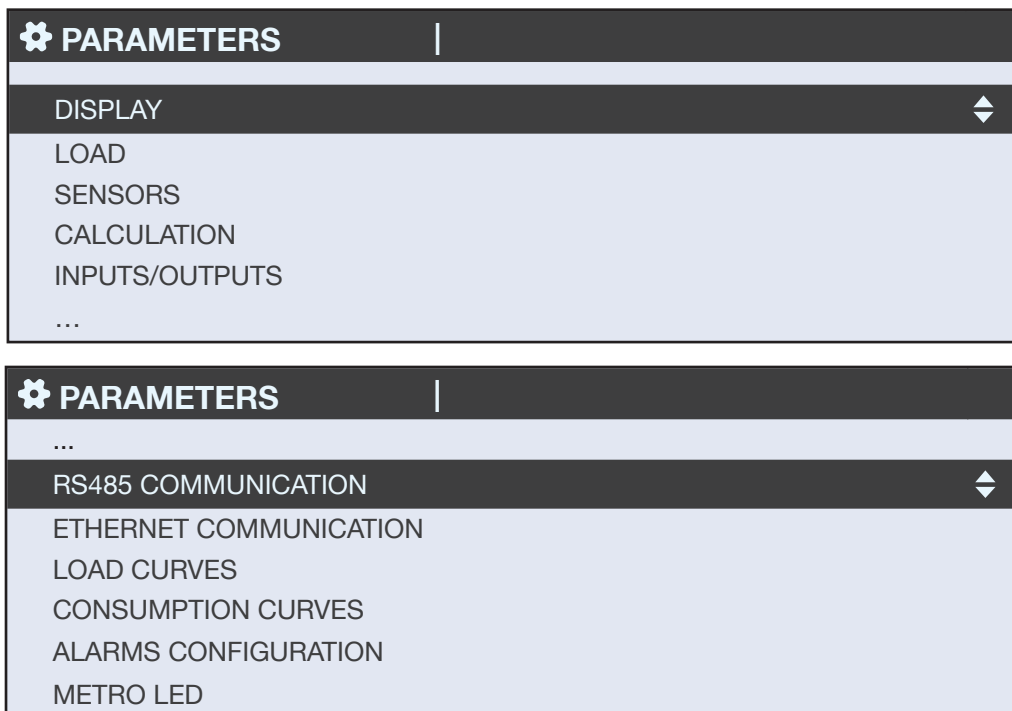

- DISPLAY: selection of the language, of the date and time and of the access code
- LOAD: selection of the type of load, of the nominal current, of rotation and of the voltage transformer
- SENSORS: selection of current direction
- CALCULATION: selection of the instantaneous and mean integration period
- INPUTS/OUTPUTS: settings of the inputs and outputs
- RS485 COMMUNICATION: settings of the RS485 communication parameters
- ETHERNET COMMUNICATION: settings of the Ethernet communication parameters
- PROFIBUS COMMUNICATION: settings of the Profibus communication parameters
- LOAD CURVES: settings of the integration period, synchronisation and selection of the calculated load curves
- CONSUMPTION CURVES: settings of the integration period and synchronisation of the consumption curves
- ALARMS CONFIGURATION: configuration of the alarms
- METRO LED: settings of the metrological LED parameters

7.4. Screen menu structure

Menu structure

Measurements	Voltages	Phase-neutral voltage	
		Phase-phase voltage	
		Frequency	
		Phase-neutral voltage unbalance	
		THD Phase-neutral voltage	
		THD Phase-neutral network	
		Phase-neutral voltage harmonics	
		Phase-neutral voltage crest factor	
		Phase-phase voltage unbalance	
		THD Phase-phase voltage	
		Phase-phase voltage harmonics	
		Phase-phase voltage crest factor	
		Current	Current
			System Current
	Current Unbalance		
	Current THD		
	Currents K factor		
	Current Harmonics		
	Current crest factor		
	Power		Active power
		Reactive power	
		Apparent power	
		Predictive power	
		Power factor	
		Cos Phi	
		Tan Phi	
	Energy	Positive active energy	
		Negative active energy	
		Positive reactive energy	
		Negative reactive energy	
		Positive/negative inductive/capacitive reactive energy	
		Apparent energy	
	Reset	Reset of all the min/max values	
Inputs/outputs	Digital inputs	Status	
	Digital outputs	Status	
Events	In progress	Alarms and Quality Events in progress	
	History	Alarms and Quality Events ended and logged	
Configuration Wizard		Wizard configuration screens	
Parameters	Screen	Languages, Date format, Date, Time, Configuration access code	
	Loads	Type of loads, Nominal values (V, I, f), Rotation, Voltage transformer	
	Sensors	Current direction, Transformation ratio detected	
	Integration period	Integration period instantaneous values and mean values	
	Inputs/outputs	Name, Function (status, circuit breaker, pulse meter), Mode (N.O., N.C.)	
	RS485 communication	Baudrate, stop bit, parity, address	
	Ethernet communication	DHCP, IP Address, Template, Router	
	Load curves	Integration period, Synchronisation, Choice of load curves to be saved (P+, P-, Q+, Q-, S)	
	Consumption curves	Integration period, Synchronisation	
	Alarm configuration	Alarm on instantaneous measurement, Alarm on digital input, System alarm	
	Metrological LED	Choice of energy allocated to the LED (Ea+, Ea-, Er+, Er-, Es)	
About	IP address		
	MAC address		
	Serial number		
	Software version		
	Reboot		

 Note: the menus available depend on the product models.

8. USE

8.1. Browse

Browsing through the "MEASUREMENTS" menu allows access to all the measurements.

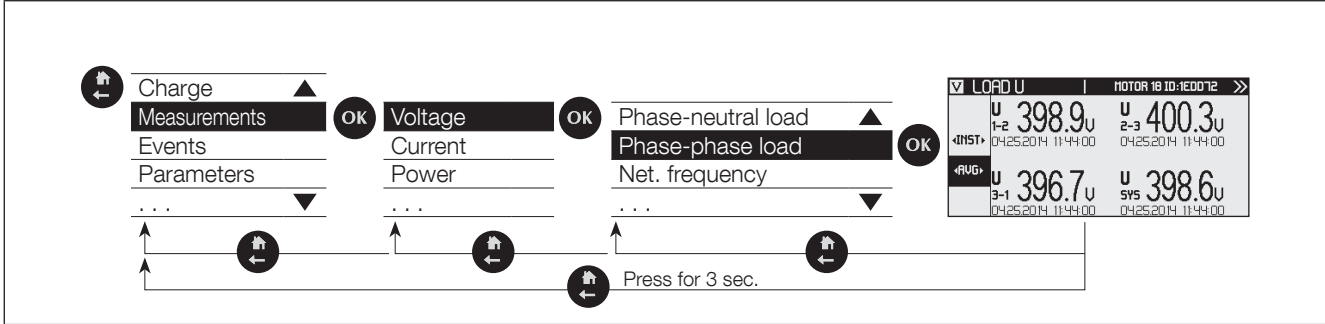

8.2. Shortcuts

The shortcut keys of the display "IP", "E", "VF" allow quick access to the current, power, energy, voltage or frequency measurements.

	Shortcut keys for load measurements: current, active power, reactive power, apparent power, power factor, cosinus phi
	Shortcut keys for electrical network measurements: phase-to-neutral voltage, phase-to-phase voltage, frequency Shortcut keys for the Wizard by holding down
	Shortcut keys for active, reactive, apparent power counters (total and partial readings)
	Shortcut key for cycling to the next load by holding down the button

8.3. Favourites

Use the Favourites function to save specific screens and to access them directly without browsing through the menus.

	Use this to save favourite screens by holding down and then to view them with a short press Use this to remove favourite screens by holding down
--	---

8.4. Screen display of measurements

The instantaneous and/or mean values are displayed depending on the types of measurement, shown as a numerical value or in graphic form.

9. WEBSERVER EMBEDDED IN THE DIRIS A-200

A webserver is embedded for the remote visualisation of measurement data.
To connect to the A-200's webserver, enter its IP address in the address bar of your web browser.
Default Ethernet parameters of the DIRIS A-200 are as follows:



- IP address: 192.168.0.4
- Mask: 255.255.255.0
- Gateway: 192.168.0.1

9.1. User profiles

Several profiles are available:

- User (default)
- Advanced User
- Admin
- Cyber security

The Advanced User, Administrator and Cyber security profiles are authorised to modify settings.

Profile	Access	Default password
User	<ul style="list-style-type: none"> - Visualisation of measurement data - Access to diagnostics 	None
Advanced User	<ul style="list-style-type: none"> - Visualisation of measurement data - Access to diagnostics + Password management of the Advanced User profile + Reset of counters 	Advanced
Admin	<ul style="list-style-type: none"> - Visualisation of measurement data - Access to diagnostics + Password management of the Admin profile + Access to configuration menu 	Admin
Cyber security	<ul style="list-style-type: none"> - Visualisation of measurement data - Access to diagnostics - Password management of all profiles - Access to configuration menu + Cyber Security configuration menu + Firmware upgrade via web server 	Cyber

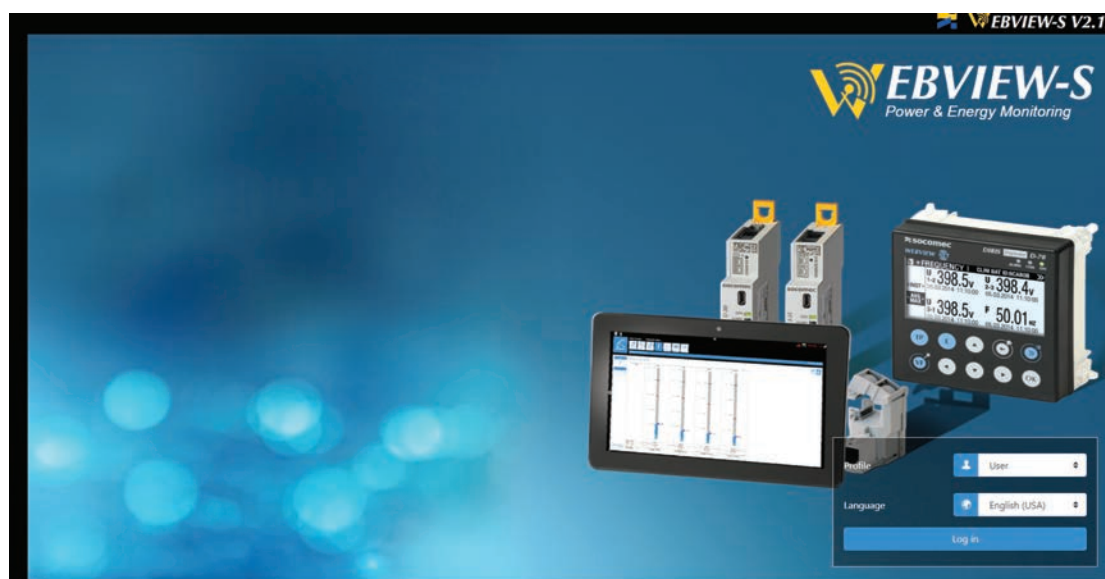

When connecting to the Admin, Advanced User or Cyber security profiles for the first time, it is mandatory to change default passwords. If these passwords are not changed, the "Password alert" alarm will remain active.

Totem User profile is locked by default. If the use of the Totem User profile is needed, you must connect with the Cyber Security profile, go to the "Profile" menu and unlock the Totem User profile.

It is highly recommended to change all default passwords right away, especially the password of the Cyber security profile which has the highest privileges including changing passwords for other accounts.

Once passwords have been changed, connect to the Cyber security profile, go to the “Profile” menu and click on “Generate the passphrase”:

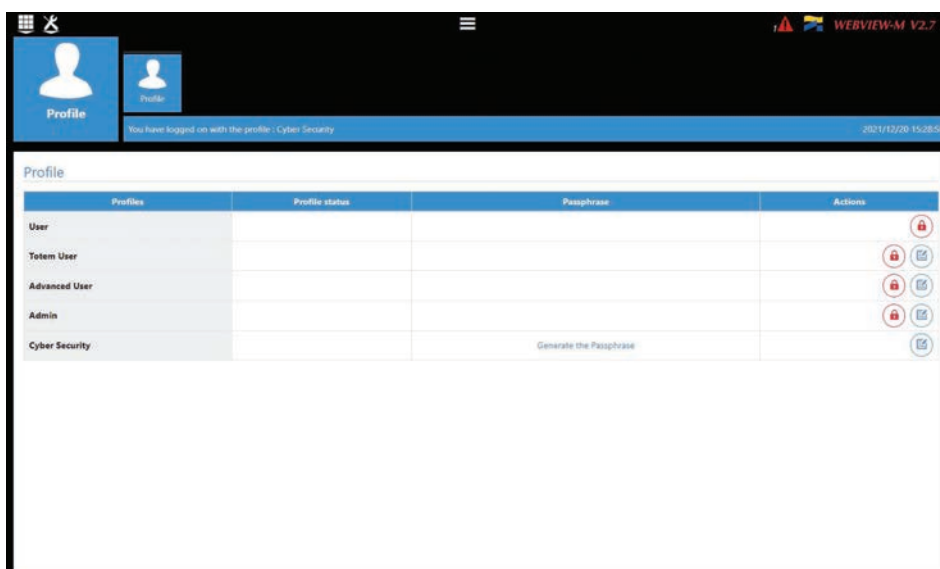

Copy the passphrase using the “Copy passphrase” button on the right side of the key, paste it somewhere and keep it safe. This will allow you to recover your password for the Cyber security account, should you lose it.

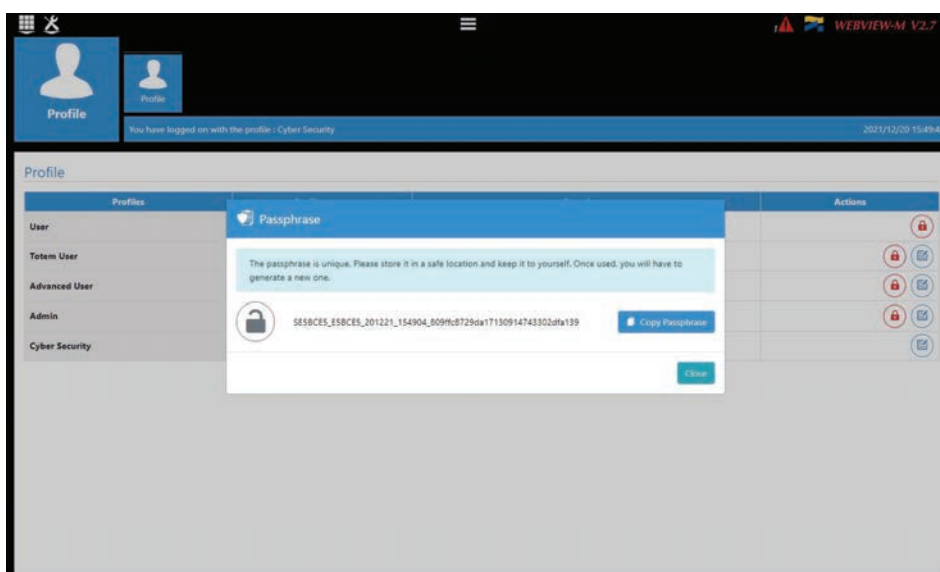

If you have forgotten to save the passphrase, the only option left is to reset the A-200 to factory default settings



Default profile lockout policy: 3 unsuccessful login attempts to the Admin, Advanced User or Cyber security profile will lock it for 1 hour. If you do not wish to wait 1 hour, you can reboot the A-200 display.

The lockout policy can be modified in the "Cyber Security" menu, in the "Security Policy" tab:

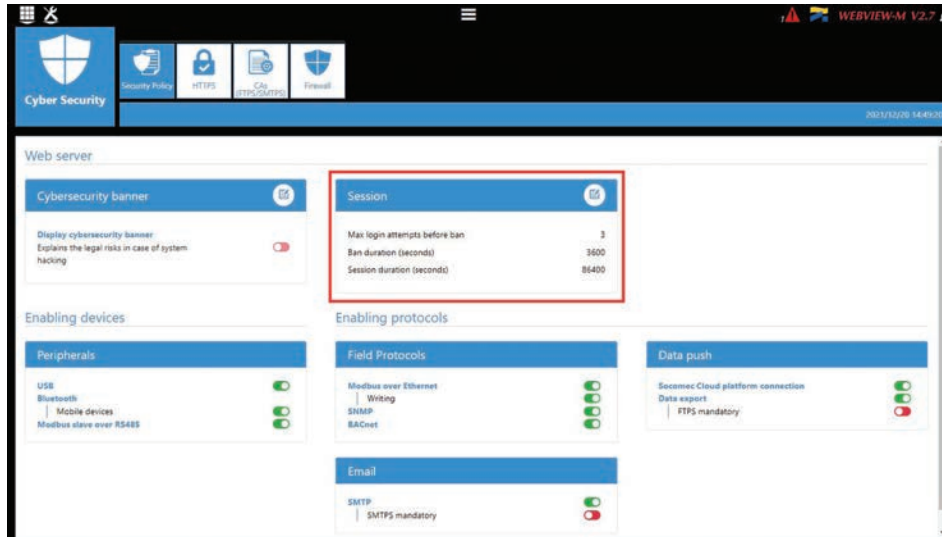

9.2. Admin profile

When connected as Admin, you can access the configuration page by clicking on the “wrench/screwdriver” icon on the top left corner:



9.2.1. “Devices” menu

- Go to the “Devices” menu:



- In this menu you can see the overview of your DIRIS A-200 settings (communication settings, configuration of the load(s) and advanced settings such as configuring a Photoview diagram or planning data logger information. You can also setup email notifications in case of alarm or events.

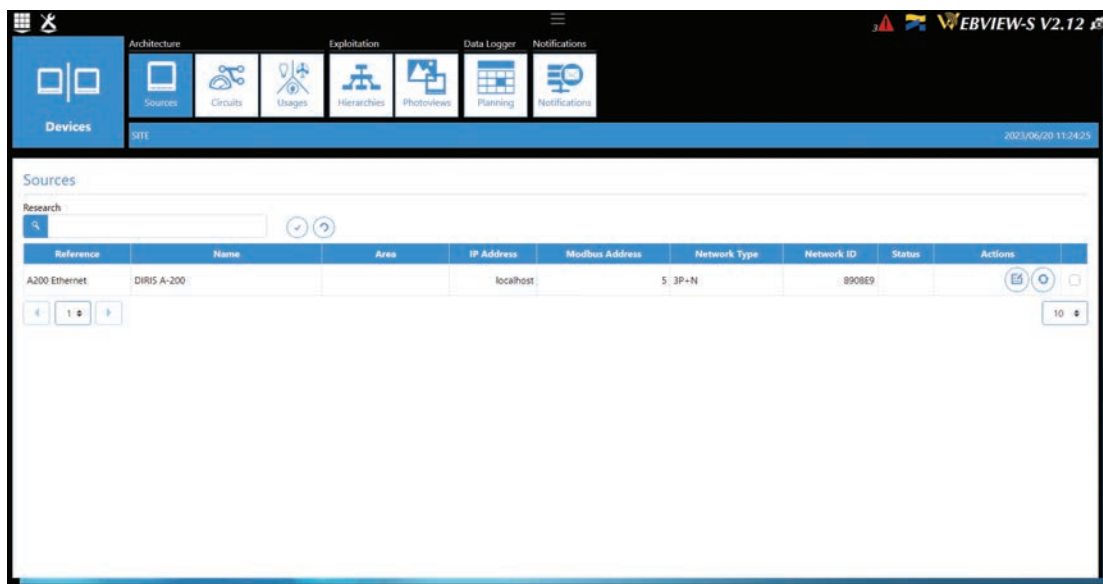

9.2.2. “Protocols” menu

Once the system is fully configured to visualise measurements and consumption on WEBVIEW-S, the communication protocols which will be used by the A-200 display to exchange data with an external supervisor (SCADA, Energy Management System, etc.) can be configured from the “Protocols” menu:



- **Network Configuration**

This tab allows you to modify the A-200's IP configuration:

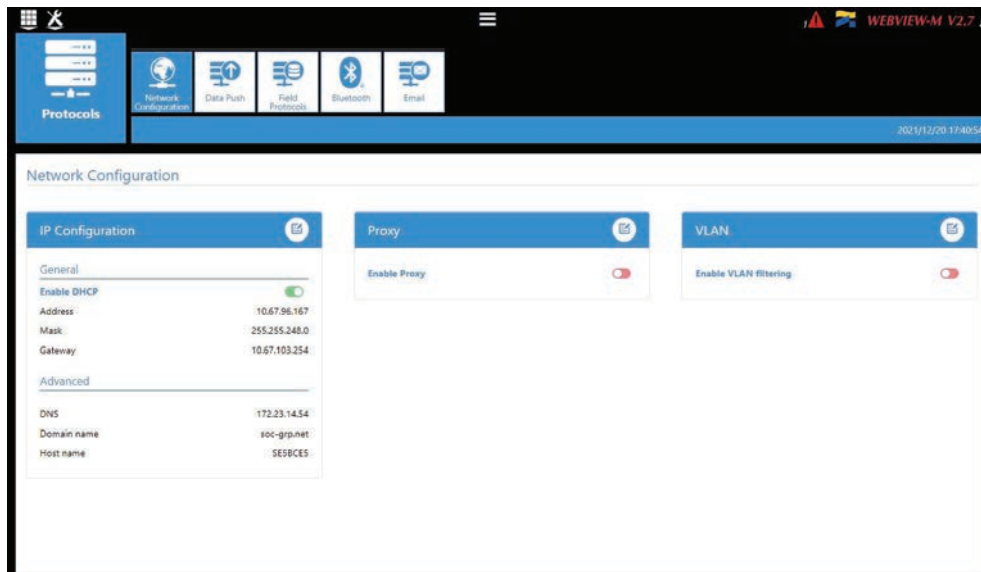

After modifying those parameters, a reboot of the A-200 is necessary.

• Data Push

- Identification

- Site name: This setting is essential to connect the A-200 to a physical location within the project structure. Default Site name is "SITE" and must be changed (in EMS export mode only) or a system alarm will be triggered.
- Server name: Unique identifier of the display. The default server name is the ID shown in the bottom right corner of the home screen of the A-200.

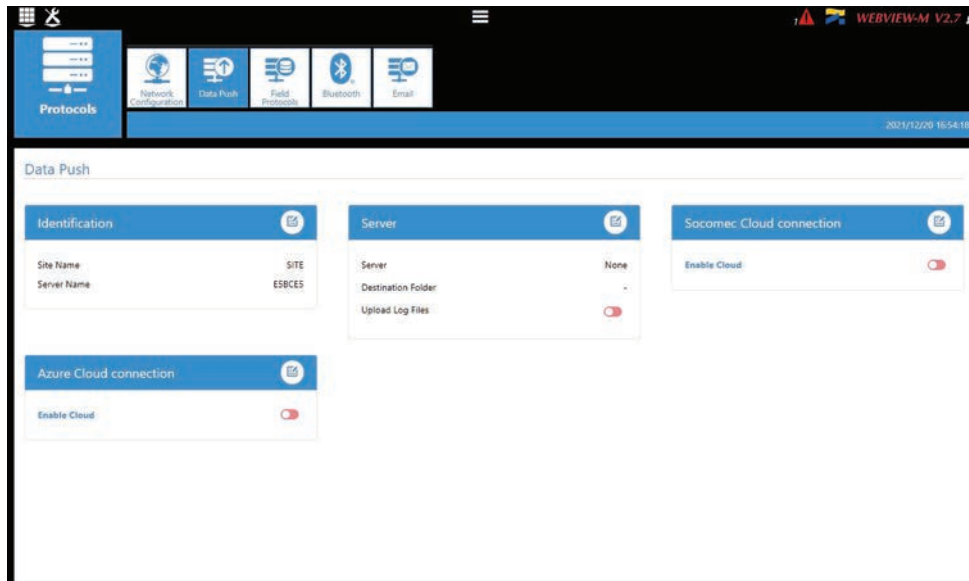

- Server

- Server: To send data files to a remote server, the Administrator selects the FTP(S) server
- Destination folder: Enter the remote server directory for receiving the files
- Upload log files: Select if you want the display to also send the log file to the remote server
- Address: Enter the IP address of the remote server
- Port: Enter the software port (usually 20 or 21 for FTP and 990 for FTPS)
- User name: enter the user name the access the remote server. It must be consistent with the User name configured on the FTP server.
- Password: enter the password to access the remote server. It must be consistent with the password configured on the FTP server.
- Secure communication: open a secure session between the display and the remote server
- File format: data can be exported in different file formats (CSV and EMS – see appendices 1 and 2). The CSV format is easier to use while EMS is better for importing data into an external energy management software.
- Test connectivity: Test the FTP export function

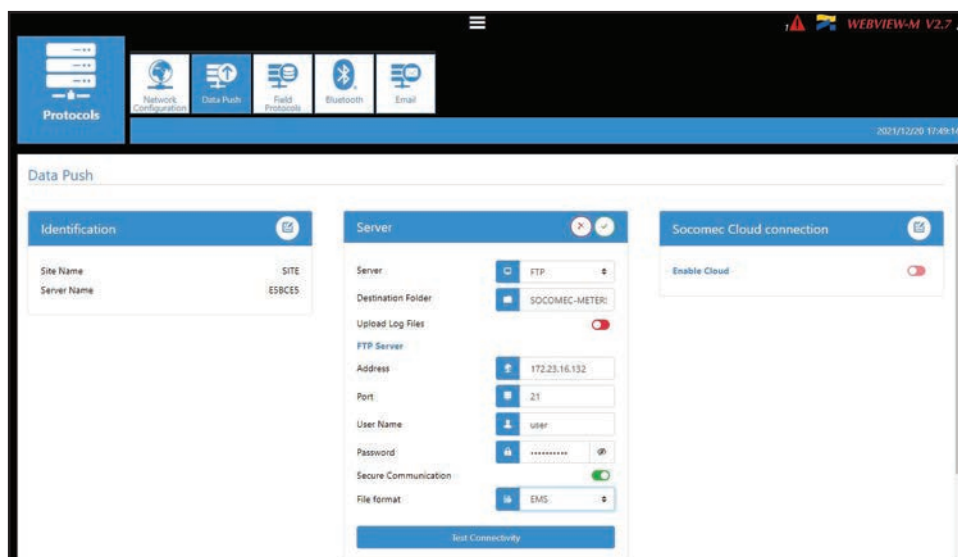

- **Field protocols**

- Communication: allows you to configure the different protocols that the A-200 can use to communicate to external energy management systems.

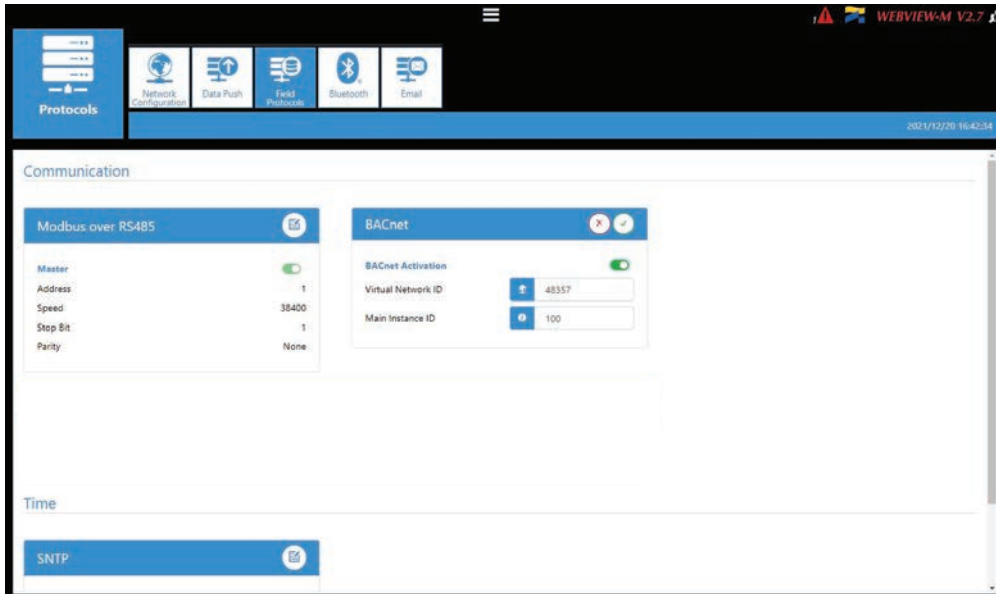

- Time: allows you to configure an SNTP server to automatically synchronise the clock of the A-200 to an external computer.

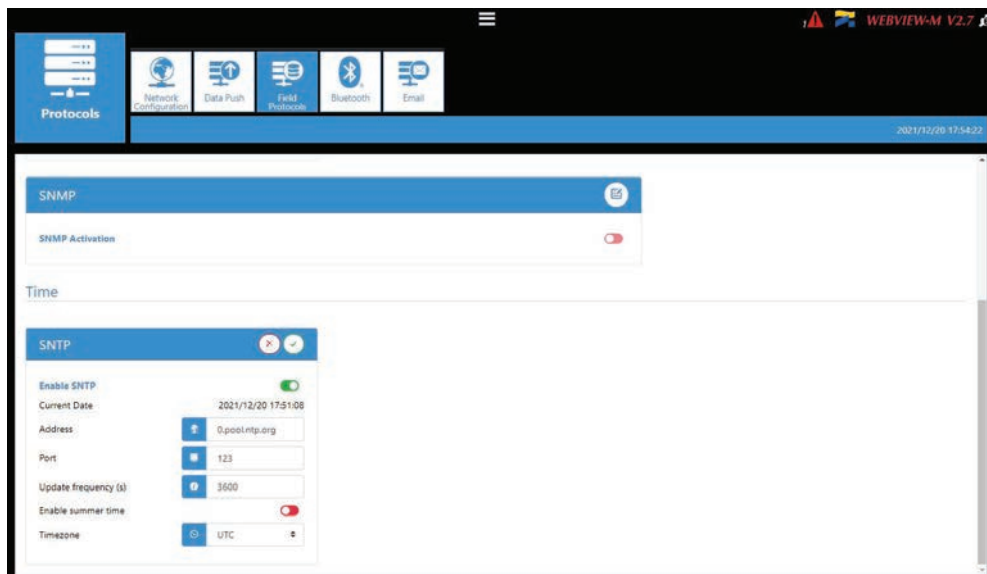

• Email

This tab allows you to activate and configure email notifications in case of alarms:

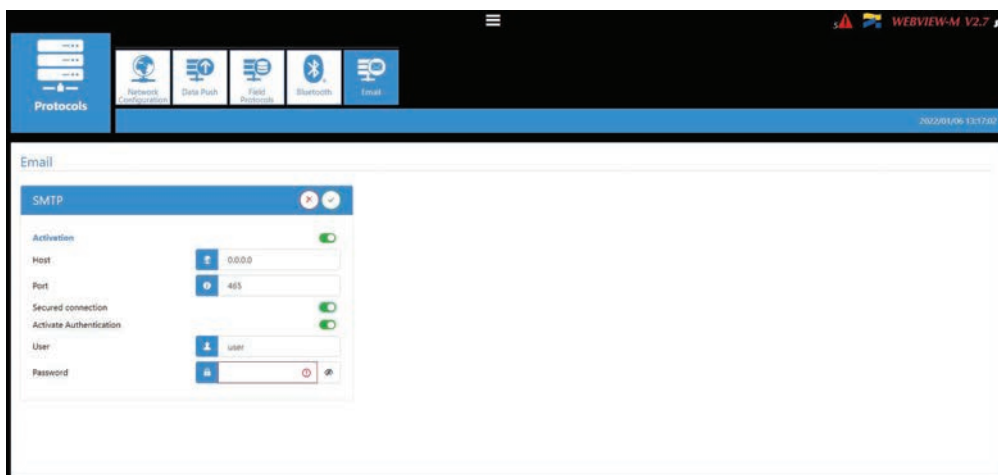

- Activation: enable/disable the SMTP email export function
- Host: enter the IP address or Host name of the SMTP server
- Port: enter the SMTP port
- Secured connection: enable or disable the secured connection (SMTPS)
- Activate Authentication: enable or disable the SMTP authentication. It is possible to activate the authentication, even if the secured connection is disabled.
- User: enter the user name for the authentication
- Password: enter the password for the authentication

Once the SMTP server has been configured, go to the "Devices" menu, "Notifications" tab to configure the email notification settings (source and recipient email address, notification frequency etc.):

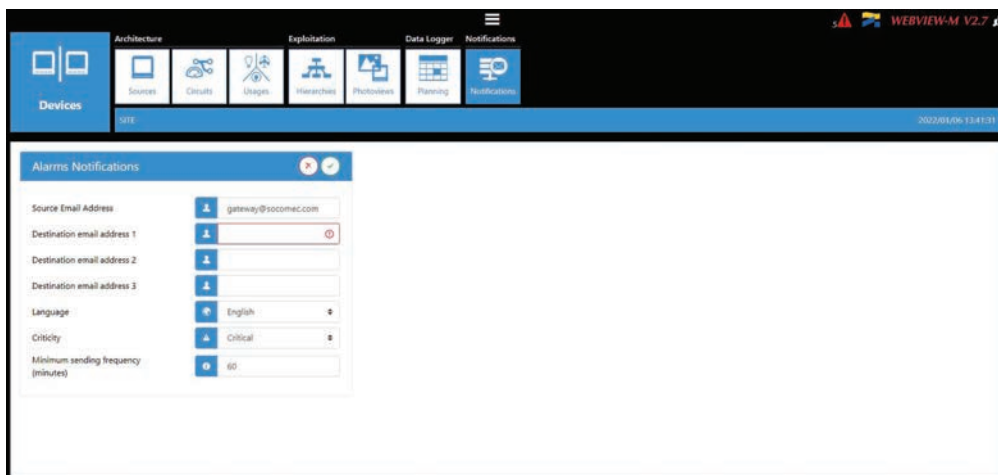

- Source email address: email address used by the A-200 to send emails
- Destination email address 1: email address #1 to which email notifications will be sent
- Destination email address 2: email address #2 to which email notifications will be sent
- Destination email address 3: email address #3 to which email notifications will be sent
- Language: language in which emails are sent
- Criticality of alarms to send: choose to send "information" or "Non critical" or "Critical" alarms
- Maximum waiting time: Time to wait to receive the email notification after the alarm is triggered on a device. This allows to limit the number of emails sent by the A-200, especially when the alarm repeatedly changes state.

9.3. Cyber security profile

In addition to the rights of the Admin profile, the Cyber security profile allows you to:

- Manage all profiles and change their passwords. The Cyber security profile also allows to generate the passphrase for password recovery.
- Implement a custom Cyber Security policy from a dedicated menu:



9.3.1. Cyber security menu

The Cyber Security menu allows you to:

- Define a custom security policy.
- Secure the client-server communication (HTTPS, FTPS, SMTPS).
- Prevent denial-of-service attacks by implementing a firewall in the A-200.

The configuration of Cyber security functions is explained in paragraphs 9.3.2 through 9.3.4.

9.3.2. “Security Policy” tab

DIRIS A-200 can reduce the attack exposure by disabling certain peripherals or services that are not essential to the customer’s use case.

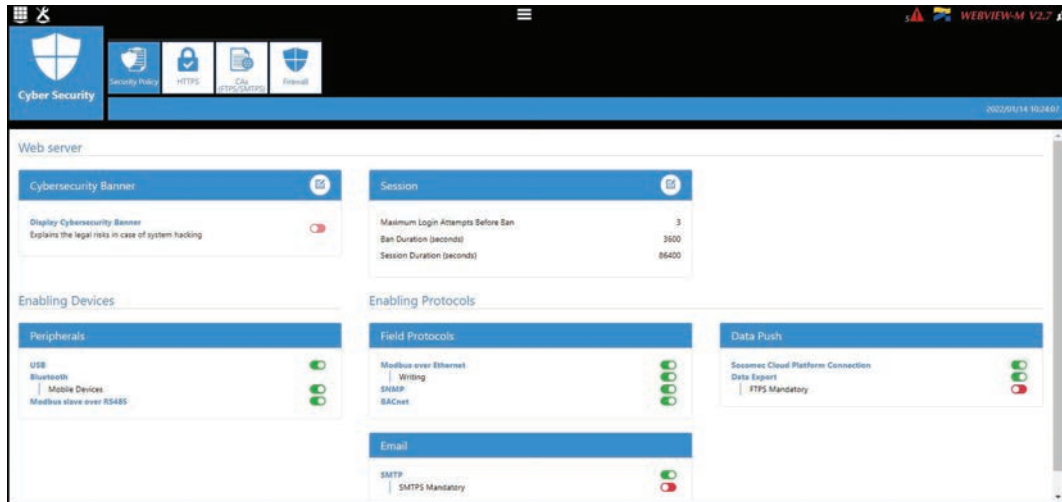

Cybersecurity Banner

Choose if you want to display the cybersecurity banner which explains the legal risks in case of system hacking. The message will be displayed on login page.

Session

You can customise the session policy (maximum login attempts before profile lockout, lockout duration and session duration).

Peripherals

- USB: disable the USB port of the A-200.

Email

- Make the secure version of SMTP mandatory for email notifications in case of alarm on a connected device.

Field protocols

- Modbus Write function: authorise or disable to prevent people from changing settings over Modbus.
- SNMP: allow or disable the use of the SNMP protocol.
- BACnet: allow or disable the use of the BACnet protocol.

Data push

- Socomec cloud platform: authorise or block the export of data to the Socomec platform.
- Data export, FTPS mandatory: force the data export to an FTP server with a secure connection.

9.3.3. “HTTPS” tab

The HTTPS tab allows you to upload a digital certificate to secure the web navigation:

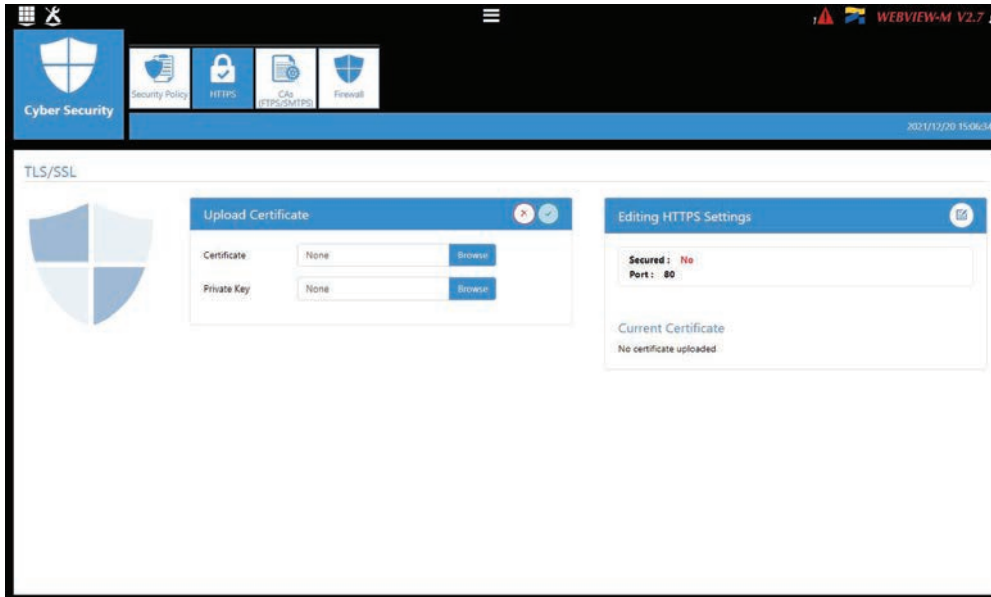

The A-200 will accept a digital certificate under the .pem format. Once a digital certificate and private key has been uploaded, you can edit HTTPS settings to secure the web navigation.

- The A-200 are compatible with RSA and ECDSA (Elliptic Curve Digital Signature Algorithm) digital certificates. The use of ECDSA digital certificates is recommended to optimise the speed of the web navigation.
- The private key size must not exceed 2048 Bits.

9.3.4. CAs (FTPS/SMTPS) tab

This tab allows you to secure the client to server (FTPS, SMTPS) communication by adding the relevant Certificate Authorities (CA) on the Client side.

Several common Certificate Authorities are already included to the A-200, but the user can add others if necessary.



Refer to Annex. II for more information on how to find and upload a server's CA to a DIRIS A-200.

9.3.5. "Firewall" tab

This tab allows you to implement a firewall to protect against Denial-Of-Service attacks also called Flooding attacks by entering a max bandwidth in kbit/s and a max number of requests per second:

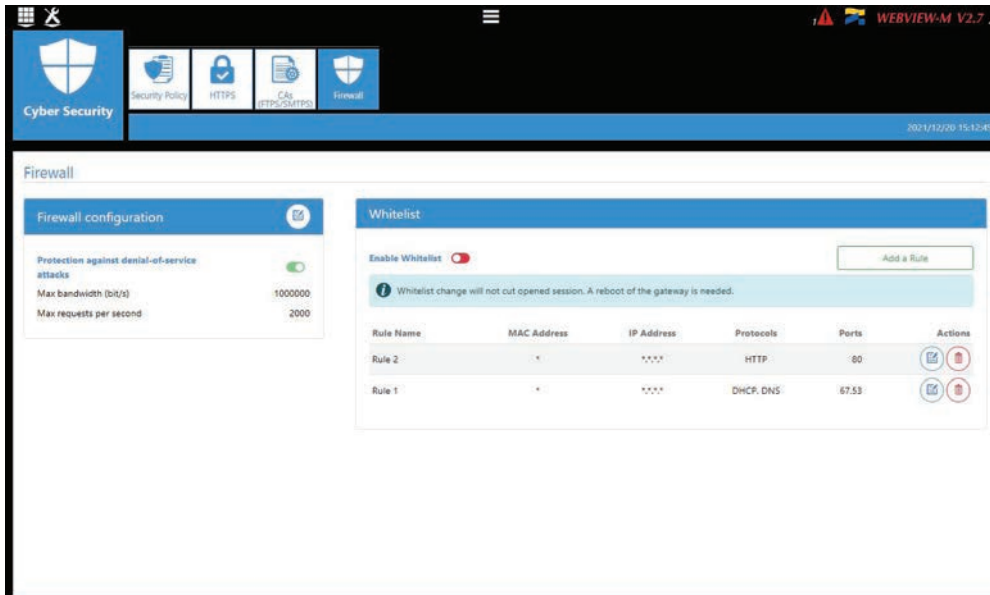

A client exceeding one of the above parameters while communicating to the DIRIS A-200 will be blocked for 30 seconds. The Whitelist part allows to add rules to filter the communication between hosts and the A-200 on MAC Addresses / IP Addresses / Protocols / Ports.

Up to 10 rules can be set.

- "*" in the MAC address column allows all MAC addresses.
- 192.168.*.* allows all IP addresses starting with 192.168.

9.3.6. Upgrading the firmware of the A-200

To upgrade the firmware of the DIRIS A-200, go to the "System" menu:



Go to the “Upgrade” tab:

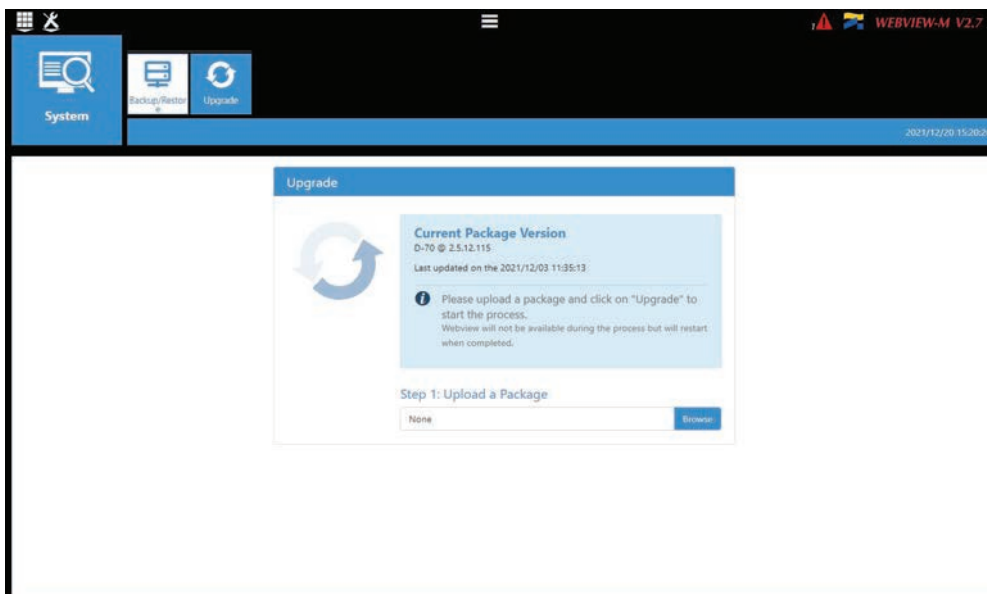

Upload the desired firmware package (.dfu file) by clicking on the “Browse” button.

Wait until the package is loaded, and once package consistency check is finished, click on “Upgrade”:

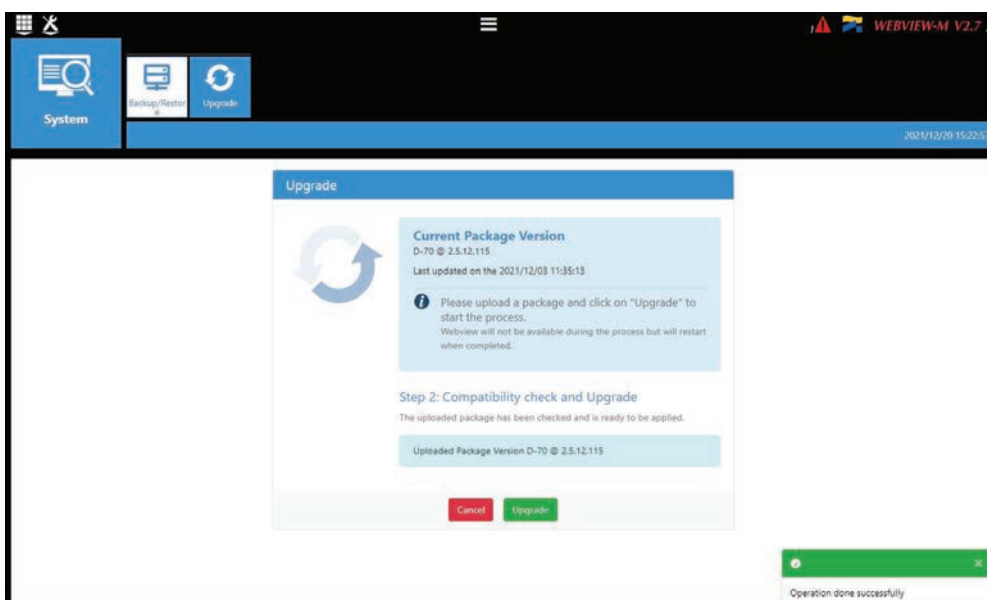

Once the upgrade is finished, the web page will reload automatically:

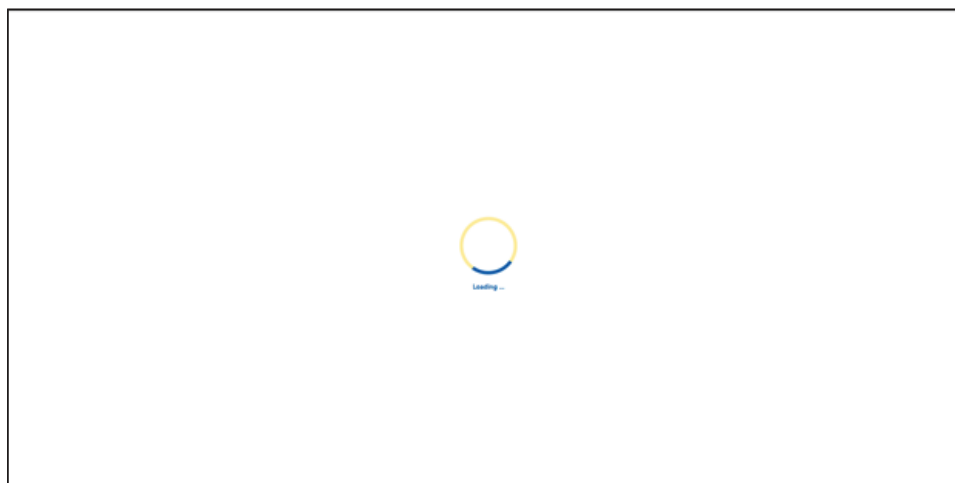

9.4. WEBVIEW-S

For more information on the visualisation of measurement data, please refer to the Webview-S instruction manual, available on the Socomec website at the following link:

https://www.socomec.com/range-software-solutions_en.html?product=/webview_en.html

10. CHARACTERISTICS

10.1. DIRIS A-100 / A-200 characteristics

10.1.1. Mechanical features

Casing type	Fitted on a door with format 96x96
Protection index	Casing: NEMA 250 Type 1, Front side: NEMA 250 Type 3R*
Type of screen	Capacitive touch-screen technology, 10 keys Screen resolution: 350 x 160 pixels
Weight	326 to 349 g depending on the reference

*Front face only. The use of a silicone seal may be required to ensure sufficient sealing of the junction between DIRIS A-xxx display and the panel door.

10.1.2. Electrical specifications

Control power supply	
Voltage	115-600VAC L/N L/L' Overvoltage category III
Frequency	50-60 Hz
Power consumption	5VA
Connection (Use copper conductors only)	Removable spring-cage terminal block, 2 positions, 28~12 AWG (1 - 2.5 mm ²) solid or stranded cable with end piece

10.1.3. Measuring characteristics

Standards		
Measurement accuracy	ANSI C12.20	Class 0.2 for active energy, meter alone
	CEC Revenue grade	CEC Revenue grade (<2% accuracy), listed on California Energy Commission's solar equipment list
	IEC 61557-12 According to table 8	Class 0.2 for active energy, meter alone Global accuracy class from 2% to 120% of I _n (meter + sensors): - Class 0.5 , in case of use with TE, iTR, TF, ACTL-1250, TCL-B sensors - Class 1, in case of use with TR or ACTL-0750 sensors
	IEC 62053-21 -24 According to table 3	Class 0.2 active energy meter alone, class 1 reactive energy meter alone
Voltage measurement		
Specified accuracy range	50-830V L-L (Wye) or 50-600 V L-L (Delta) or 50-960V L-L (split-phase)	
Permanent Overvoltage	1039VAC L-L	
Withstand	5400 VAC / 5s and 3600 VAC / 1min	
Measurement category	III	
Frequency range	45 to 65Hz	
Network type	Single-Phase, Two-Wire, Line-to-Neutral, Single-Phase, Two-Wire, Line-to-Line, Single-Phase, Three-Wire (Split-Phase), Three-Phase, Three-Wire Delta, Three-Phase, Four-Wire Wye, Three-Phase Four-Wire Delta (High Leg)	
Measurement by voltage transformer	Primary: 400 000 VAC Secondary: 60, 100, 110, 173, 190 VAC	
Input consumption	≤ 0,1 VA	
Connection (Use copper conductors only)	Removable spring-cage terminal block, 4 positions, 28~12 AWG (1 - 2.5 mm ²) solid or stranded cable with end piece	
Current measurement		
Number of current inputs	4	
Associated current sensors	RJ12 100mV smart sensors: solid-core TE, split-core TR and iTR, flexible TF current sensors, ΔIC circular solid-core and ΔIP-R circular split-core residual current transformers, T-10 adaptor. 333 mV current transformers: split-core ACTL-0750-xxx, ACTL-1250-xxx, solid-core TCL-B-xxx.	
Connection	Specific Socomec cable with RJ12 connectors	

Function	Overall operating characteristics (in compliance with IEC 62020-1) DIRIS A-200 100 mV + T-10 adapter + dedicated residual CT	Measurement range
Operating characteristic in presence of residual currents	RCM Type A with: - T-10 adaptor and $\Delta I_C \geq \emptyset 15$ mm or ΔI_P -R residual CTs - $\Delta I_C \emptyset 8$ mm residual CT	9 mA to 3 A
Residual current (I_{Δ} , I_{PE})	$\pm 3\%$ with ΔI_C , ΔI_P -R residual CTs	9 mA to 2 A
Maximum actuating time (T_{max})	8.5 s	9 mA to 3 A
Minimum non-actuating time (T_{min})	1.5 s	

10.1.4. Input/output characteristics

Inputs	
Number	3
Type / Power supply	Optocoupler with internal (12 VDC \pm 10%) or external (10-30VDC) polarisation
Input function	Logical state, pulse meter, circuit breaker status or synchronisation pulse (input 1)
Connection	Removable screw terminal block, 5 positions, stranded or solid 18~16 AWG (0.5 - 1.5 mm ²)
Outputs	
Number	1
Type	Optocoupler 30 Vd.c. max 20mA max - SELV
Output function	Configurable alarm signal (current, power, etc.) when threshold is exceeded or remote controlled status
Connection	Removable screw terminal block, 4 positions, stranded or solid 18~16 AWG (0.5 - 1.5 mm ²)

10.1.5. Communication specifications

RS485	
Product	DIRIS A-100 / A-200
Link	RS485
Connection type	2 to 3 half duplex wires - SELV
Protocol	Modbus RTU
Baudrate	9600 to 115200 bauds
Function	Data configuration and reading
Connection	Removable screw terminal block, 3 positions, stranded or solid 18-16 AWG (0.5 - 1.5 mm ²)
ETHERNET	
Product	DIRIS A-200 ref. 4825 0604 and 4825 0605
Link	Ethernet
Connection type	Dual Ethernet (2 ports) 10/100 Base-T - SELV
Protocol	Modbus TCP (port 502), Modbus RTU over TCP (port 503) BACnet, SNTP, SMTP(S), FTP(S), HTTP(S), BACNet IP, DHCP
SNTP protocol	Updates from an NTP server.
SMTP protocol	Sends a mail in case of an alarm
FTP protocol	Saves the measurement files on an FTP server
Functions	Data configuration and reading
Connection	RJ45 port
BACNET IP	
Product	DIRIS A-200 ref. 4825 0604 and 4825 0605
Link	Ethernet
Protocol	BACNET IP
Functions	Data reading
Connection	RJ45 port
USB	
Connection	USB 2
Protocol	Modbus RTU on USB
Function	Configuration
Connection	Type B micro USB connector

10.1.6. Environmental specifications

Ambient operating temperature	-25 ... +70°C / -13 to +158°F (ANSI C12.1)
Storage temperature	-40 ... +85°C / -40 to +185°F (ANSI C12.1)
Operating humidity	5 to 95% RH non condensing (ANSI C12.1)
Operating altitude	Up to 3000 m (9842 ft)
Vibration	30 ... 350 Hz, 0.5g (ANSI C12.1)
PEP ecopassport - ISO 14025	SOCO-00055-V01.01-EN
Impact resistance	Half-sine pulse, 15 g, 11 ms (ANSI C12.1)
Location	Indoor

10.1.7. Electromagnetic compatibility

Immunity to electrostatic discharges on contact	IEC 61000-4-2	LEVEL III	Criterion A
Immunity to electrostatic discharges in the air	IEC 61000-4-2	LEVEL III	Criterion A
Immunity to radiated radio-frequency fields	IEC 61000-4-3	80 MHz – 1 GHz LEVEL III 1.4 GHz - 6 GHz LEVEL II	Criterion A
Immunity to electrical fast transients/bursts	IEC 61000-4-4	Power supply LEVEL III Voltage measurement LEVEL III Current inputs LEVEL III RS485 LEVEL III Ethernet LEVEL III I/O LEVEL III Functional Earth LEVEL III	Criterion B
Immunity to impulse waves (surge)	IEC 61000-4-5	Power supply LEVEL III Voltage measurement LEVEL III RS485 LEVEL II Ethernet LEVEL II I/O LEVEL II	Criterion A
Immunity to conducted disturbances, induced by radio-frequency fields	IEC 61000-4-6	Power supply LEVEL III Voltage measurement LEVEL III 333 mV current inputs LEVEL II 100 mV current inputs LEVEL III RS485 LEVEL II Ethernet LEVEL III I/O LEVEL III Functional Earth LEVEL III	Criterion A Criterion A Criterion A Criterion A Criterion A Criterion A Criterion A
Immunity to power frequency magnetic fields	IEC 61000-4-8	400 A/m	Criterion A
Immunity to voltage dips, short interruptions and voltage variations	IEC 61000-4-11	Voltage dip: 0% for 1 cycle	Criterion A
		40% for 10/12 cycles	Criterion B
		70% for 25/30 cycles	Criterion B
		Short interruption: 0% for 250/300 cycles	Criterion B
Radiated emissions	CISPR11	Gr:1 - CLASS A	N/A
Conducted emissions	CISPR11	Gr:1 - CLASS A	N/A

 **CAUTION!** The user that changes modifications not expressly approved by the party responsible for compliance could void the user's authority to operate the equipment.
This device complies with part 15 of the FCC Rules. Operation is subject to the following two conditions: (1) This device may not cause harmful interference, and (2) this device must accept any interference received, including interference that may cause undesired operation.

 Note: This equipment has been tested and found to comply with the limits for a Class A digital device, pursuant to part 15 of the FCC Rules. These limits are designed to provide reasonable protection against harmful interference when the equipment is operated in a commercial environment. This equipment generates, uses and can radiate radio frequency energy and, if not installed and used in accordance with the instructions manual, may cause harmful interference to radio communications.

Operation of this equipment in a residential area is likely to cause harmful interference in which case the user will be required to correct the interference at his own expense.

10.1.8. Safety

Safety	Compliant with Low Voltage Directive: 2014/35/EU of 26 February 2014 (IEC EN61010-1 & IEC EN61010-2-030) + CB Scheme Compliant with Electromagnetic Compatibility Directive: 2014/30/EU of 26 February 2014
Insulation	Installation category III (600VAC Ph/N), degree of pollution 2
UL	UL61010-1 & UL61010-2-030 UL installation: DIRIS A-100 and DIRIS A-200 models with RJ12 current sensors inputs: Product and their associated sensors have to be enclosed inside an NRTL certified electrical/fire enclosure, Listed "Industrial Control Panel" DIRIS A-100 and A-200 models with 333mV current transformers inputs and associated with UL2808 compliant CTs: Product and their associated CTs have to be enclosed inside an NRTL certified electrical/fire enclosure listed as either "Industrial control panel", "Panelboard" or "Switchgear"

10.1.9. Service life

MTTF (mean time to failure)	> 95 years
-----------------------------	------------

10.2. TE, TR / iTR and TF sensor characteristics

TE - solid-core sensor TE-18 to TE-55						
Model	TE-18	TE-18	TE-25	TE-35	TE-45	TE-55
Nominal current range I _n (A)	5 - 20	25 - 63	40 - 160	63 - 250	160 - 630	400 - 1000
Max. current (A)	24	75.6	192	300	756	1200
Weight (g)	24	24	69	89	140	187
Max. voltage (AC)	300 V					600 V
Rated withstand voltage	3 kV					3.6 kV / 1min
Frequency	50/60 Hz					
Intermittent overload	10x I _n in 1 second					
Measurement category	CAT III					
Protection degree	IP30 / IK06					
Operating temperature	-10 ... +70°C					
Storage temperature	-25 ... +85°C					
Relative humidity	95% RH without condensation					
Altitude	< 2,000 m					
PEP ecopassport - ISO 14025	TE sensors: SOCO-2014-03-v1-fr, SOCO-2014-03-v1-en					
UL	UL 61010					
Connection	SOCOMEK RJ12 cables: UTP, unshielded, twisted pair, straight, AWG24, 600V, CATV, -10 ... +70°C					

TE - solid-core sensor TE-90	
Model	TE-90
Nominal current range I _n (A)	600 - 2000 A ⁽¹⁾
Max. current	2400 A
Weight	163g (118g without clamps)
Max. voltage (AC)	600 V
Rated withstand voltage	3.6 kV AC 1 min
Frequency	50/60 Hz
Intermittent overload	40x I _n in 0.5 sec
Measurement category	CAT III
Protection degree	IP30 / IK06
Operating temperature	-10 ... +70°C
Storage temperature	-25 ... +85°C
Relative humidity	95% RH without condensation
Altitude	< 2,000 m
Connection	SOCOMEK RJ12 cables: UTP, unshielded, twisted pair, straight, AWG24, 600V, CATV, -10 ... +70°C.

(1) 5A CT adaptor (max primary current is 10 000 A for 5A CT).

TR/iTR - Split-core sensor				
Model	TR-10 / iTR-10	TR-14 / iTR-14	TR-21 / iTR-21	TR-32 / iTR-32
Nominal current range I_n (A)	26 - 63	40 - 160	63 - 250	160 - 600
Max. current (A)	75.6	192	300	720
Weight (g)	74	117	211	311
Max. voltage (AC)	300 V			
Rated withstand voltage	3 kV			
Frequency	50/60 Hz			
Intermittent overload	10x I_n in 1 second			
Measurement category	CAT III			
Protection degree	IP20 / IK06			
Operating temperature	-10 ... +55°C			
Storage temperature	-25 ... +85°C			
Relative humidity	95% RH without condensation			
Altitude	< 2,000 m			
PEP ecopassport - ISO 14025	TR sensors: SOCO-2014-04-v1-fr, SOCO-2014-04-v1-en			
UL	UL 61010 conformity			
Connection	SOCOMEK RJ12 cables: UTP, unshielded, twisted pair, straight, AWG24, 600V, CATV, -10 ... +70°C			

TF - Flexible current sensor						
Model	TF-40	TF-80	TF-120	TF-200	TF-300	TF-600
Weight (g)	90	130	142	164	193	274
Nominal current range I_n (A)	100 ... 400	150 ... 600	400 ... 2000	600 ... 4000	1600 ... 6000	1600 ... 6000
Max. voltage (AC)	600 V					
Measurement category	CAT III					
Frequency	50/60 Hz					
Power ratings (d.c.)	3.3V / max. 10mAC (exclusively from specified PMD)					
Accuracy	Performance class for power and energy: 0.5 in combination with DIRIS Digiware I, according to IEC 61557-12					
Intermittent overload	10x I_n for 1 second					
Rated withstand voltage	3.6 kV					
Protection degree	IP30 / IK07					
Operating temperature	-10 ... +70°C					
Storage temperature	-25 ... +85°C					
Relative humidity	95%					
Pollution degree	2					
Altitude	< 2,000 m					
Connection	SOCOMEK RJ12 cables: UTP, unshielded, twisted pair, straight, AWG24, 600V, CATV, -10 ... +70°C					

11. PERFORMANCE CLASSES

11.1. Specification of the characteristics

Symbol	Function	Overall operating performance class DIRIS A-100 / A-200 with dedicated sensors (TE, TR, iTR, TF, ACTL-1250 Opt. C0.2, ACTL-750 Opt C0.6, TCL-B) according IEC 61557-12	Measurement range
P, Ea	Total active power, Total active energy	0.2 DIRIS A-100 / A-200 alone 0.5 with TE, iTR, TF, ACTL-1250 Opt C0.2, TCL-B sensors 1 with TR, ACTL-750 Opt. C0.6 sensors	5% ... 120% In 2% ... 120% In 2% ... 120% In
Q	Total reactive power	1 DIRIS A-100 / A-200 alone 1 with TE, iTR, TF, ACTL-1250 Opt C0.2, TCL-B sensors 2 with TR, ACTL-750 Opt. C0.6 sensors	5% ... 120% In
Er	Total reactive energy	2	5% ... 120% In
S, Eap	Total apparent power, Total apparent energy	0.2 DIRIS A-100 / A-200 alone 0.5 with TE, iTR, TF, ACTL-1250 Opt C0.2, TCL-B sensors 1 with TR sensors	10% ... 120% In
f	Frequency	0.02	45 ... 65 Hz
I	Phase current	0.1 DIRIS A-100 / A-200 alone 0.5 with TE, iTR, TF, ACTL-1250 Opt C0.2, TCL-B sensors 1 with TR, ACTL-750 Opt. C0.6 sensors	5% ... 120% In
U, V	Voltage (Lp-Lg or Lp-N)	0.1	12 ... 600 VAC L/N 40 ... 1038 VAC L/L
PF	Power factor	0.1 DIRIS A-100 / A-200 alone 0.5 with TE, iTR, TF, ACTL-1250 Opt C0.2, TCL-B sensors 1 with TR, ACTL-750 Opt. C0.6 sensors	0.5 ind. ... 0.8 cap.
Vnba, Vnb	Voltage amplitude unbalance (Lp(Lg or Lp-N))	0.2	80% ... 120%Vn
Inba, Inb	Current unbalance	0.2 DIRIS A-100 / A-200 alone	10% ... 120%Vn
Vh, THDv, THRv	Voltage harmonics, Total harmonic distortion rate of the voltage (relative to the fundamental, relative to the efficient value)	1	Orders 1 to 63
Ih, THDi, THDRi	Current harmonics, Total harmonic distortion rate of the current (relative to the fundamental, relative to the efficient value)	1	Orders 1 to 63

ANNEX I. FTP CONFIGURATION

Annex I - 1. FTP file export protocol

Measurement logs can be automatically exported via FTP(S).

Annex I - 1.1. FTP server activation:

Click on the “Wrench” icon on the top left corner and click on “Protocols”:



Click on “Data Push”.

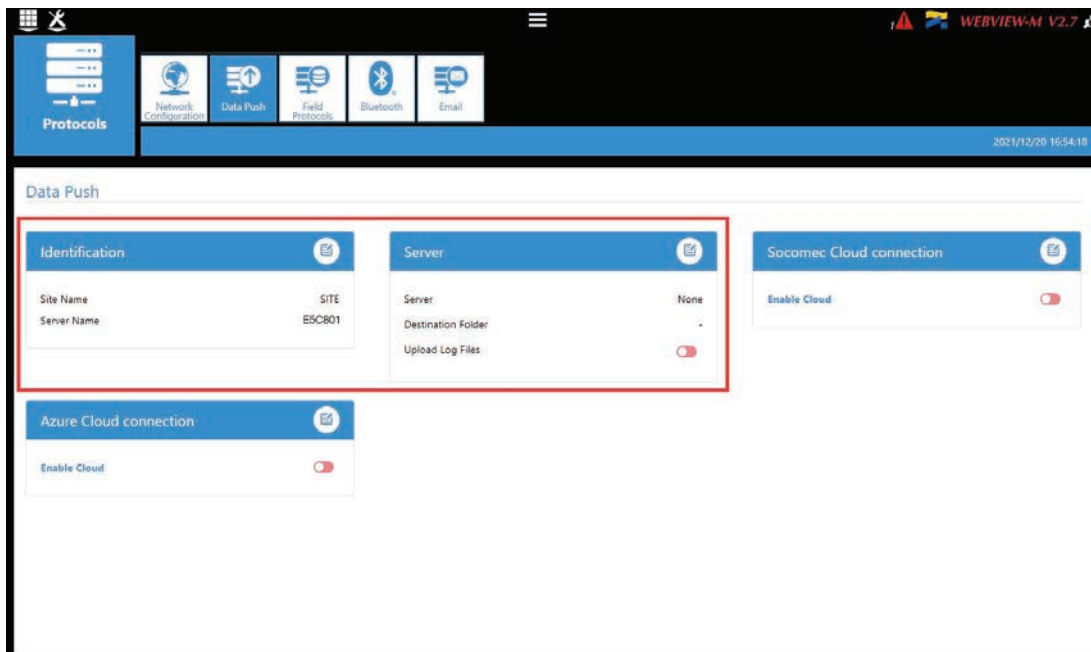

Identification part:

Site Name & Server Name: used to identify from which DIRIS A-200 the files are being exported.

The default site name is "SITE" (must be modified if the export mode is set to EMS) and the default server name corresponds to the ID shown in the bottom right corner of the home screen of the A-200.

Server part:

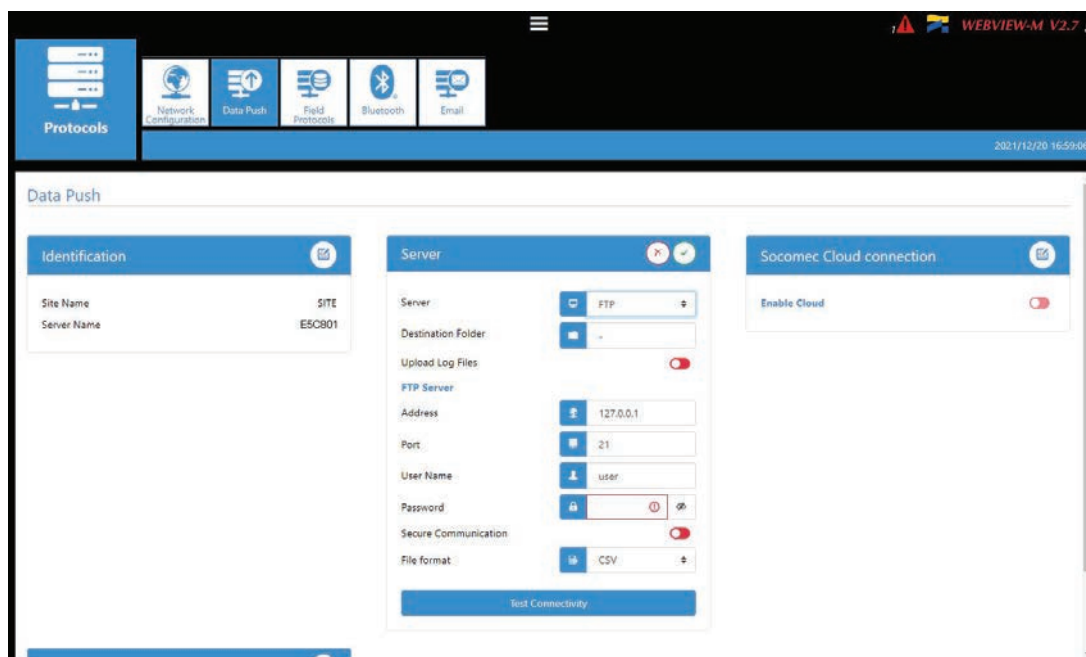

Server: activate the FTP server to enable the automatic export of data to a remote FTP server.

Destination folder: tree view of the FTP server folder in which you want to export the files.

Upload Log files: activate this to have additional information for troubleshooting in case of an export issue.

FTP Server: This contains the login details of the FTP server (standard or secure).

Address: enter the IP address of your FTP server

Port: enter the secured or non-secured port to use for the FTP export

User Name: enter the user name the access the remote server. It must be consistent with the User name configured on the FTP server.

Password: enter the password to access the remote server. It must be consistent with the password configured on the FTP server.

Secure Communication: activate or deactivate the secured export (FTPS)

File format: there are two different types of data file

- **CSV:** file in which data is in a user-friendly layout
- **EMS:** file in .csv format whose layout is more practical to integrate into an energy management software.

In EMS mode, the exported files are named according to the following:

Site name_Server name_Device name_Data type_date_time.csv

Example: if an export file is named "**socomec_E5C801_I35_LoadCurve_2017-08-15_20-00-00.csv**", then the file was exported on August 15th, 2017 at 20:00 (8:00pm), it contains Load curves (Demand Power) from a device named I35 from a gateway whose Server name is E5C801 and Site name is socomec.



In EMS mode, the Site Name must be different from default name ("SITE"), or the "FTP error" system alarm will be triggered.

Test Connectivity: once the configuration is done, you can test the connectivity by manually exporting a test file.

Annex I - 2. FTP planning configuration

Click on “Devices”:



Click on “Planning”:

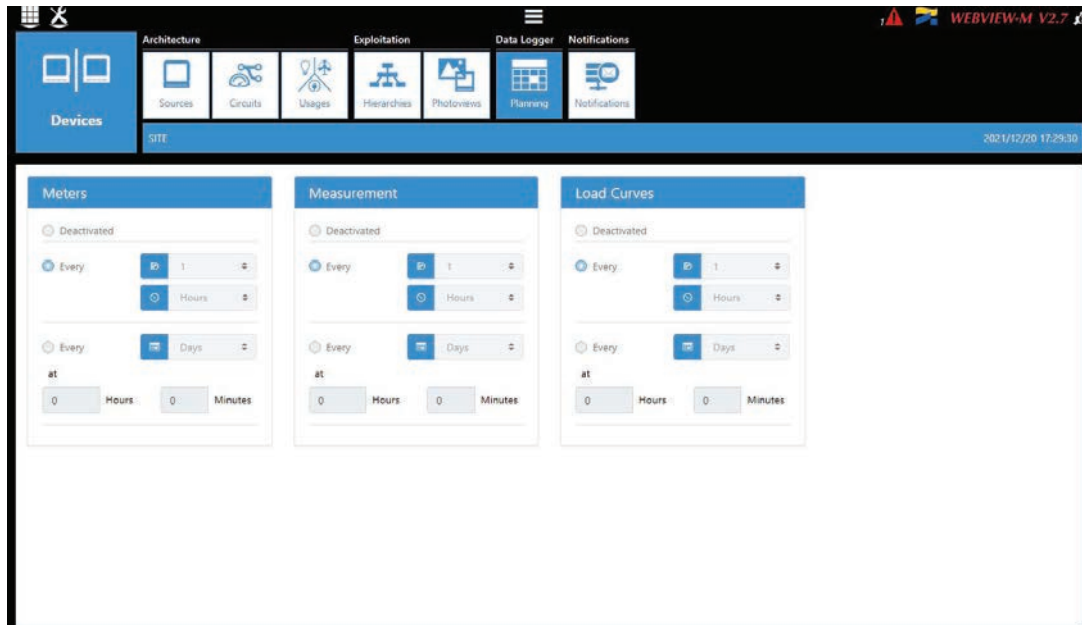

Activate the type of data you want to export automatically. The DIRIS Digiware D-70 can log and export 3 types of data:

Energies Index: Ea, Er, Es etc. (Meters)

Measurement logs/trends: archived parameters U, I, F, PF etc. (Measurements)

Load curves / demand: P, Q, S etc. (Load curves)

For each data type, specify the export frequency (once an hour, once a day etc.) and at which time.

Annex I - 3. Understanding the exported .csv file in EMS mode

socomec_E5C801_I-35@4_Avg_2019-01-18_15-15-10.csv													
A	B			C	D	E	F	G	H	I	J	K	L
1	Data Type	TimeZone			Datation	Transfer Cycle (sec)	Pooling Ti	Version	Site name		Server name		
2	Avg	UTC			Local	600	N/A	1	socomec	E5C801			
3													
4	Index Key	Key			Type	Name	Fluid	Use	Coef	Unit	Path	Device Id	Data Id
5	0	socomec	E5C801	14 1 ANA 100006	ANA	THD I1 of PC 1-2-3 of I-35@4	ELEC	Use2	100 %	/	14	1	100006
6	1	socomec	E5C801	14 1 ANA 100007	ANA	THD I2 of PC 1-2-3 of I-35@4	ELEC	Use2	100 %	/	14	1	100007
7	2	socomec	E5C801	14 1 ANA 100008	ANA	THD I3 of PC 1-2-3 of I-35@4	ELEC	Use2	100 %	/	14	1	100008
8	3	socomec	E5C801	14 1 ANA 10023	ANA	I1 AVG of PC 1-2-3 of I-35@4	ELEC	Use2	1000 A	/	14	1	10023
9	4	socomec	E5C801	14 1 ANA 10024	ANA	I2 AVG of PC 1-2-3 of I-35@4	ELEC	Use2	1000 A	/	14	1	10024
10	5	socomec	E5C801	14 1 ANA 10025	ANA	I3 AVG of PC 1-2-3 of I-35@4	ELEC	Use2	1000 A	/	14	1	10025
11													
12	Index Key	Date			Value	Quality							
13	0	2019-01-18T15:14:00			234	192							
14	0	2019-01-18T15:13:00			237	192							
15	0	2019-01-18T15:12:00			190	192							
16	0	2019-01-18T15:11:00			201	192							
17	0	2019-01-18T15:10:00			200	192							
18	0	2019-01-18T15:09:00			198	192							
19	0	2019-01-18T15:08:00			210	192							
20	0	2019-01-18T15:07:00			231	192							
21	0	2019-01-18T15:06:00			211	192							
22	0	2019-01-18T15:05:00			199	192							
23	1	2019-01-18T15:14:00			20001	192							
24	1	2019-01-18T15:13:00			21605	192							
25	1	2019-01-18T15:12:00			19804	192							
26	1	2019-01-18T15:11:00			20901	192							
27													

The csv file is split into two parts:

- The part (1) in red corresponds to the header. It contains a unique key, created out of multiple parameters such as the the site and server name, the data type, the data ID, the device ID to uniquely identify each parameter that is exported.
- The part (2) in green contains the logged and time stamped measurements. Each line is identified via the simplified index key, which refers to a unique key in cells B5 through B10.

The final value for cells C13 through C26 is obtained considering the right coefficient in cells G5 through G10 along with the right unit in cells H5 through H10.

Example for line 13:

The final value for THD I1 of circuit PC1-2-3 on module I-35@4 is equal to 2.34 % on January 18th, 2019 at 15:14:00.



When integrating data into a third-party energy management or monitoring software, always refer to the unique Key in column "B", part (1) as a unique import code and do not only use the simplified index key in column "A", part (2).

If multiple DIRIS Digiware D-70 displays are exporting to the same folder, the simplified index key cannot differentiate them.

ANNEX II. FIND AND ADD A SERVER'S CA (CERTIFICATE AUTHORITY) TO A DIRIS A-200

Requirements:

1. An unfiltered internet connection
2. OpenSSL software installed

Instructions

> Use the following command:

```
openssl s_client -connect <server>:<port> -build_chain
```

> Example for Gmail (SMTP):

```
openssl s_client -connect smtp.gmail.com:465 -build_chain
```

> Check the last line of the certificate chain in the command output:

```
$ openssl s_client -connect smtp.gmail.com:465 -build_chain
CONNECTED(00000268)
---
Certificate chain
 0 s:CN = smtp.gmail.com
  i:C = US, O = Google Trust Services LLC, CN = GTS CA 1C3
 1 s:C = US, O = Google Trust Services LLC, CN = GTS CA 1C3
  i:C = US, O = Google Trust Services LLC, CN = GTS Root R1
 2 s:C = US, O = Google Trust Services LLC, CN = GTS Root R1
  i:C = BE, O = GlobalSign nv-sa, OU = Root CA, CN = GlobalSign Root CA
```

> Go the corresponding company's website and find the page where you can download the root certificates.
For Gmail, GlobalSign Root CA: <https://support.globalsign.com/ca-certificates/root-certificates/globalsign-root-certificates>

> Download the PEM (or Base64) certificate.

If the certificate is given as text, copy the text in between BEGIN CERTIFICATE and END CERTIFICATE into a text file and save it with a .pem extension, as shown in the example below:

R1 GlobalSign Root Certificate

GlobalSign Root R1

SHA1 • RSA • 2048

Valid until: 28 January 2028

Serial #: 04:00:00:00:00:01:15:4b:5a:c3:94

Thumbprint: b1:bc:96:8b:d4:f4:9d:62:2a:a8:9a:81:f2:15:01:52:a4:1d:82:9c

Root R1 was GlobalSign's first root certificate embedded in browsers (back in 1999, Netscape and Windows 98), making Root R1 GlobalSign's oldest and most ubiquitous root certificate. The original use case was for personal certificates, but this quickly expanded as GlobalSign's business and expertise broadened. Due to its hash algorithm, GlobalSign will begin scaling back Root R1 use.

Does my browser trust this certificate?

[Download Certificate \(Binary/DER Encoded\)](#) [View in Base64](#)

```
-----BEGIN CERTIFICATE-----
MIIDdTCCA12gAwIBAgILBAAAAAABFUtaW5QwDQYJKoZIhvcNAQEFBQAwVzELMAkG
A1UEBhMCQkUxGTAXBgNVBAoTEEdsb2JhbFNpZ24gbnYtc2ExEDAOBgNVBAasTB1jv
b3QgQ0ExGzAZBgNVBAMTEkdsb2JhbFNpZ24gUm9vdCBDQTAeFw05ODAMDEzMjAw
MDEBaFw0yODAxMjgMjAwMDBaMFcxZzAjBgNVBAYTAKFMRkwFwYDVQQkExBHBG9i
YWxTaWduIG52LXNhMRAwDgYDVQQLEwdSb290IENBMRSwGQYDVQQDEjHbG9iYWxT
aWduIFJvb3QgQ0EwggEiMA0GCSqGSIb3DQEBAQUAA4IBDwAwggEKAoIBAQDaDuaZ
jc6j40+Kfvvxi4Mla+pIH/EqsLmVEQS98GPR4mdmzxzdztIK+6NiY6arymAZavp
xy0Sy6scTHAHOt0KMM0VjU/43dSMUBUc71DuxC73/OIS8pF94G3VNTCOXkNz8kHp
1Wrjsok6Vjk4bwY8iGibKk3Fp1S4blnMm/k8yuX9ifUSPJJ4ItbcdG6TRGHRJcdG
snUOhugZitVtbNV4FpWi6cgKOOvjBNPc1STE4U6G7weNLWLBYY5d4ux2x8gkasj
U26Qzns3dLlwR5EiUWMMWea6xrkEmCMgZK9FGqkVZCrXgzT/LCrBbBIDSgeF59N8
9iFo7+ryUp9/k5DPAgMBAAGjQjBAMA4GA1UdDwEB/wQEAwIBBjAPBgNVHRMBAf8E
BTADAQH/MB0GA1UdDgQWBRRge2YaRQ2XyolQL30EzTSo//z9S5ANBgkqhkiG9w0B
AQUFAAOCAQEA1nPnfE920I2/7LqivjTFKDK1fPxsncwrvQmeU79rXqoRSLbLCKOz
yj1hTdNGCbM+w6DjY1Ub8rrvrTnhQ7k4o+YviiY776BQVvnGCv04zcQLcFGU5gE
38NfNUVvRRBnMRddWQVDf9VMOyGj/8N7yy5Y0b2qvzfvGn9LhJlZjrglfCm7ymP
AbEVtQwdpf5pLGkkeB6zpxxxYu7KyJesF12KwvhHhm4qxFYxldBniYUr+WymXUad
DKqC5jIR3XC321Y9YeRq4VzW9v493kHMB65JUr9TU/Qr6cf9tveCX4XSQRjbgbME
HMUfpIBvFSDJ3gylCh3WZIXi/EjK5Zp4A==
-----END CERTIFICATE-----
```

> Connect to the webserver under the Cyber Security profile.

> Go to the Cyber Security menu:



> Click on the “CAs (FTPS/SMTSPS)” tab:

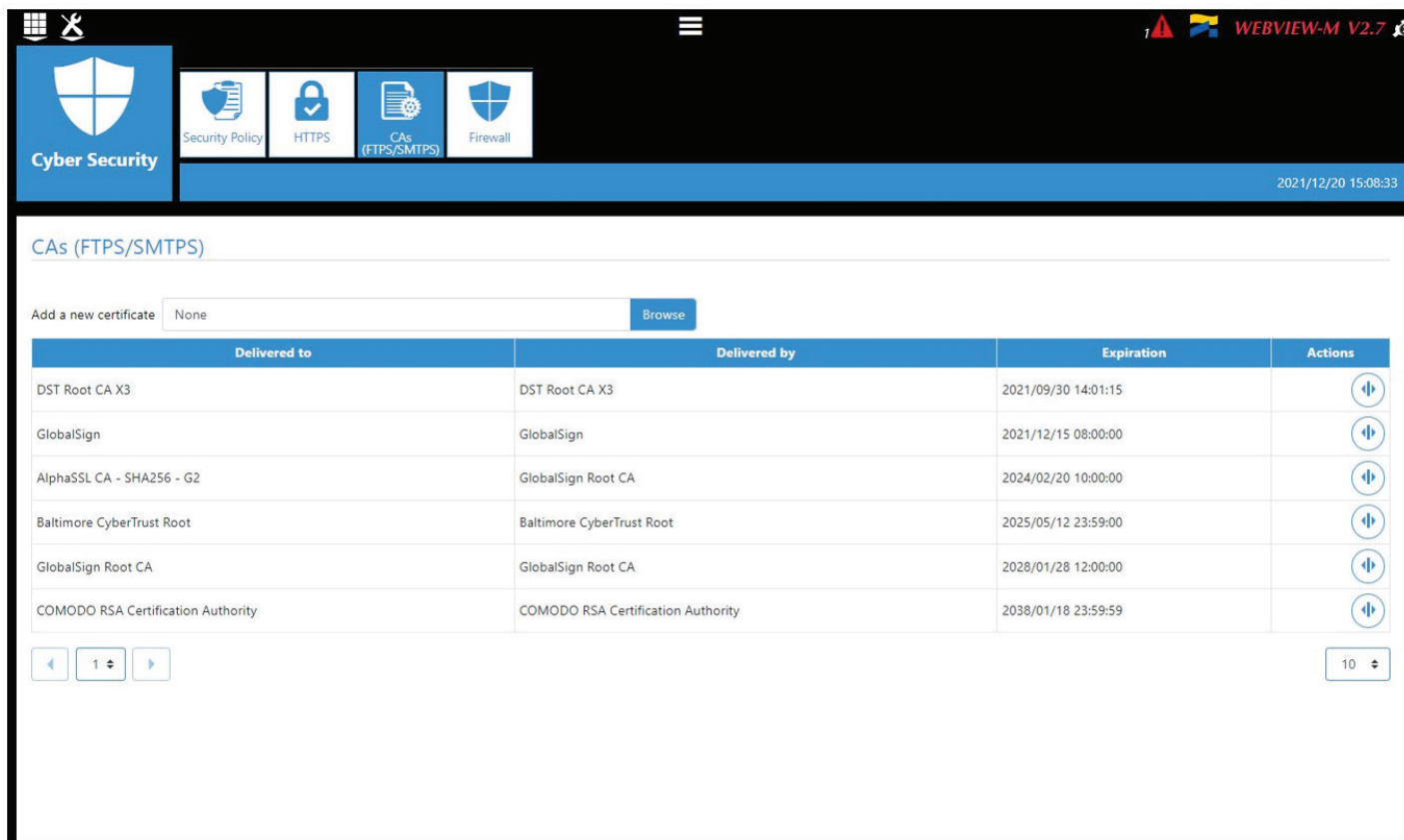

> Add the previously downloaded PEM file:



Cyber Security

Security Policy
 HTTPS
 CAs (FTPS/SMTSPS)
 Firewall

2021/12/20 15:08:33

CAs (FTPS/SMTSPS)

Add a new certificate

None

[Browse](#)

Delivered to	Delivered by	Expiration	Actions
DST Root CA X3	DST Root CA X3	2021/09/30 14:01:15	
GlobalSign	GlobalSign	2021/12/15 08:00:00	
AlphaSSL CA - SHA256 - G2	GlobalSign Root CA	2024/02/20 10:00:00	
Baltimore CyberTrust Root	Baltimore CyberTrust Root	2025/05/12 23:59:00	
GlobalSign Root CA	GlobalSign Root CA	2028/01/28 12:00:00	
COMODO RSA Certification Authority	COMODO RSA Certification Authority	2038/01/18 23:59:59	

1

10

ANNEX III. TIME OF USE

Annex III - 1. General information

Time-Of-Use (TOU) rates are the fixed electricity prices charged by utility companies to all Regulated Price Plan customers, both residential and small business.

TOU pricing varies based on the time of day and week. Special prices can also happen upon weekends, holidays, or specific days.

Example of time of use pricing and scheduling with 3 separate rates, including 2 seasons (summer / winter), with special schedules for weekends & holidays:

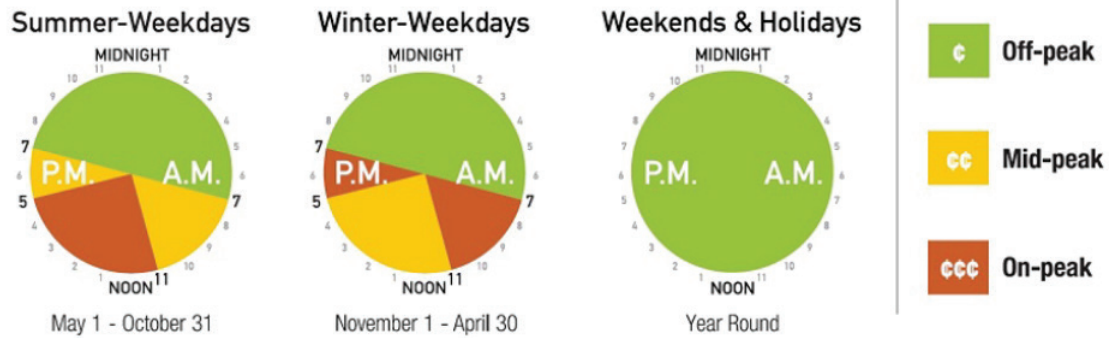

Annex III - 2. Setup the time of use.

Annex III - 2.1. STEP 1: Configure general settings and holidays

There are several ways to setup the time of use: you can use the time of use wizard in the parameters of the screen, or you can use the Drag&Drop easy to use dashboard of time of use present in the Easy Config system software.

The below help describes configuration through Easy config system software:

Go to the wrench icon on the left  .

Select your A200 device in the list of products, then, go to time of use dashboard:

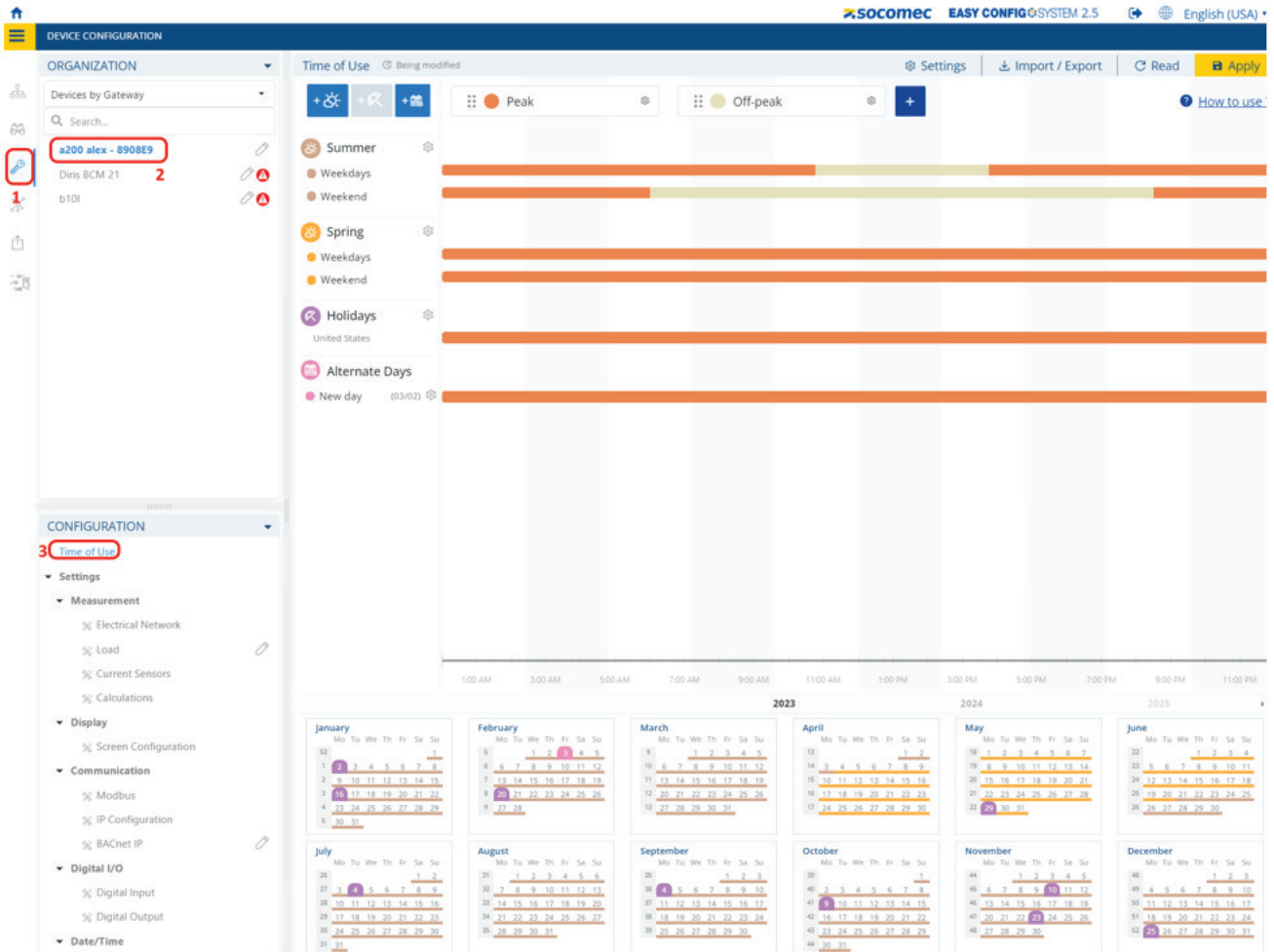

Go to general settings on top of the screen if not automatically directed there:



Choose if weekends have to be treated differently from weekdays, if yes select which days are to be considered weekends:

Weekend days

Sunday Monday Tuesday Wednesday Thursday Friday Saturday

You can also select which day is the beginning of the week.

Choose if holidays have to be treated differently from other days, if yes you can manually set each of them or start from one of the templates provided:

Time of use - Settings

Holiday template

No Holidays ▾

- United States Federal H...
- Canada Federal Holidays
- Mexico Federal Holidays
- Custom Holidays
- No Holidays

Week starting day

Sunday ▾

Tuesday
 Wednesday
 Thursday
 Friday
 Saturday

Cancel
Validate

No matter what you select, the limitation is up to 16 holidays configured.

In the even you select custom holidays, you will be invited to manually add holidays, by clicking on + Add a new holiday.

Then select which day the holiday should be, and its name:

Holiday template

Custom Holidays

Name	Type	Date
Christmas	<input checked="" type="radio"/> Exact Date <input type="radio"/> Nth Occurrence <input type="radio"/> Offset Date <input type="radio"/> Special Date	Date: January ▾ 1 January February March April May

When done, click on validate at the bottom.

You can also edit your holiday to add or delete some of them by clicking on the little wheel next to the holidays:

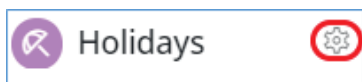

Holidays			
Holiday template			
United States Federal Holidays			
Name	Type	Date	
New Year's Day	Offset Date	Nearest Weekday 01/01	
Martin Luther King Jr. Birthday	Nth Occurrence	Third monday of January	
President's Day	Nth Occurrence	Third monday of February	
Memorial Day	Nth Occurrence	Fifth (or Last) monday of May	
Independence Day	Offset Date	Nearest Weekday 04/07	
Labor Day	Nth Occurrence	First monday of September	
Columbus Day	Nth Occurrence	Second monday of October	
Veterans Day	Offset Date	Nearest Weekday 11/11	
Thanksgiving Day	Nth Occurrence	Fourth thursday of November	
Christmas Day	Offset Date	Nearest Weekday 25/12	

Annex III - 2.2. Step 2: Configure your seasons

The time of use management is preconfigured by default with one season, meaning every days of the year are treated with the same schedule of rates during the day (unless holidays and/or alternate days are configured):

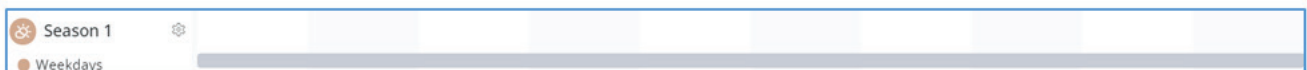

You can have up to 4 seasons configured; to do so click on the “Add season” button on the top left:

A window appears that lets you select the starting date of your new season:

Time Of Use - Season

New season

Exact Date
 Nth Occurrence
 Offset Date
 Special Date

Date: January 1

Validate

Several options are possible:

- Choose an exact date, every year the season starts at the same date
- Nth occurrence, if the season has to start the [1st-5th] [Monday-Sunday] of a specific month
- Offset date, if the season has to start the [nearest, prior, next] weekday after a given date
- Special date, if the season has to start on a special holiday

Validate your choices and the new season will appear in the configuration:

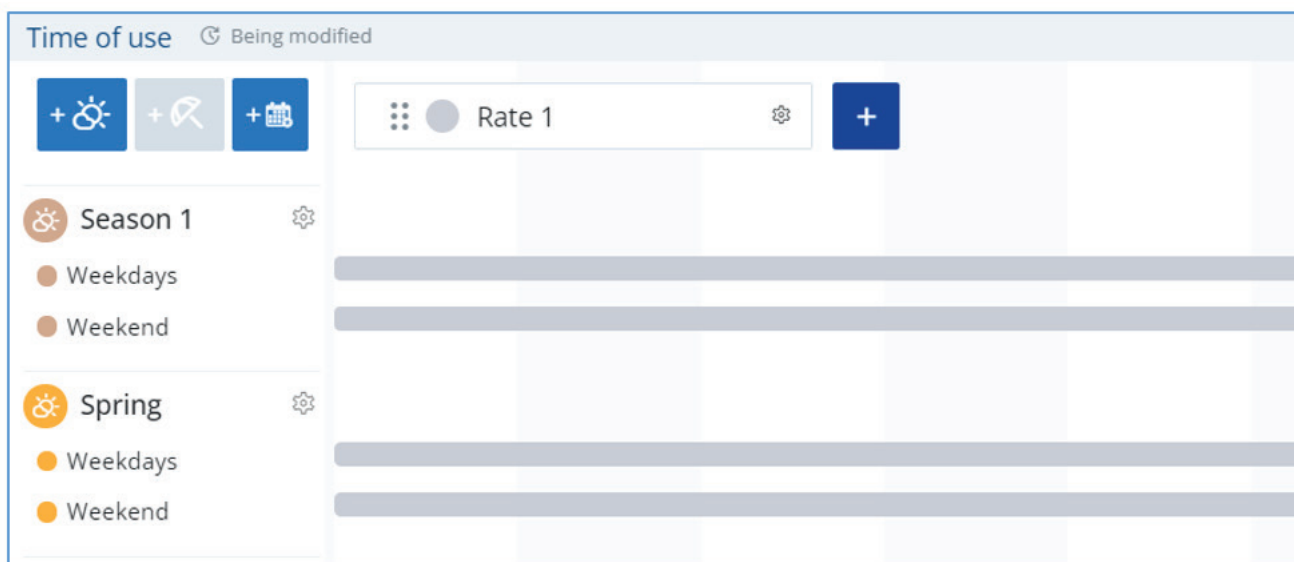

It is possible to edit your season by clicking on the little wheel next to it, if you made a mistake or if you want to delete your season:

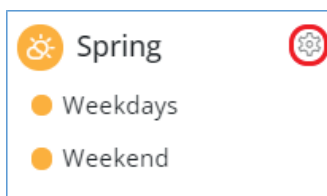

When you are done with your seasons configuration, the calendar on the bottom updates with colors. Each day is underlined with a color that reflects in which season it is in.

Additionally if you have configured holidays, the special days concerned are highlighted in blue:

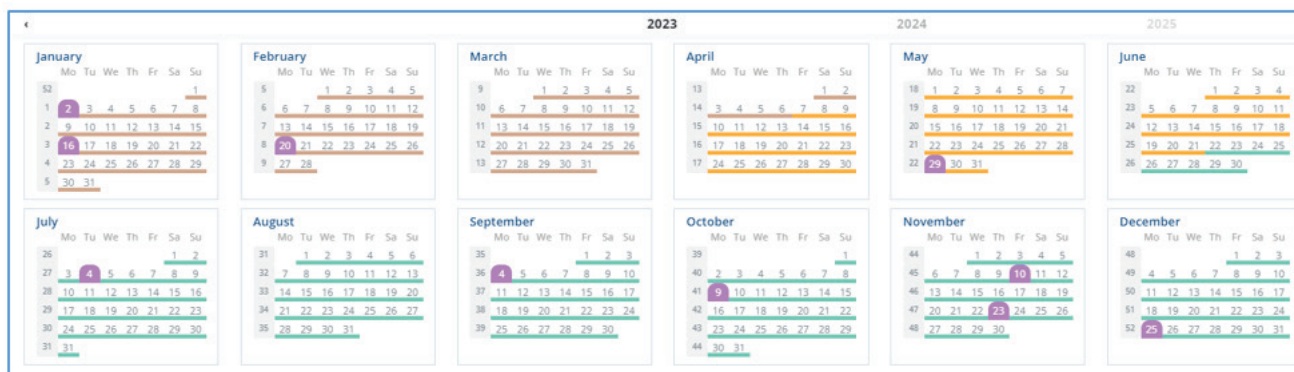

You can also see in the next years how your time of use setup will look like. This is especially important if you configured seasons as dynamic days and not exact dates, which means every year the date in which the season change occurs can be different.

Annex III - 2.3. Step 3: Configure your rates

The time of use management is preconfigured by default with one rate, meaning that each and all schedules will have the same rate throughout the day (weekdays, weekends, holidays, alternate days).

The maximum number of rates you can have is 4; to configure a new rate click on the “+” button at the top next to the first rate:



A little box appears that let you chose the color of your new rate as well as its name:



Set a name and color for your rate, then validate. The new rate is now configured.

Do the same up to 4 rates:



Now that you have configured you rates you have to affect those rates to your various schedules.

Each schedule is a full day, meaning you can split your day in different rates depending if it's a weekday, a weekend, a holiday or an alternate day.

Although you can have only up to 4 different rates, you can split each schedule in up to 8 segments.

To do so:

1. Grab a rate from one of the configured ones, and drag-and-drop it to one of your schedules below

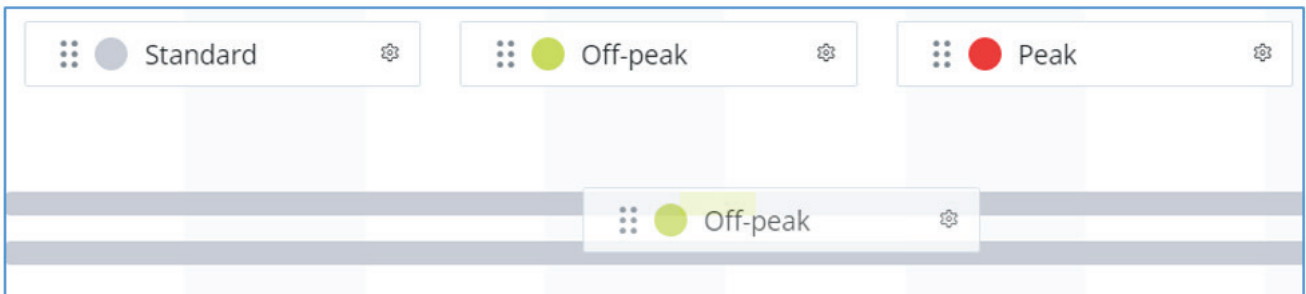

2. The rate will be placed at the time during the day on the schedule where you dropped it. By default it will last one hour:

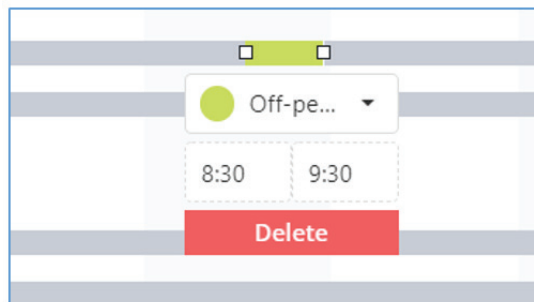

- You can enlarge or reduce the duration of your rate during the schedule by grabbing the left or right handle and dragging it to the left or to the right:

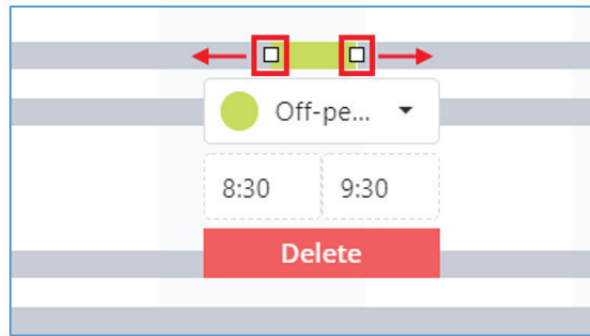

- For instance by dragging to the right you can increase the duration of this rate up until 1 PM instead of 9:30 AM:

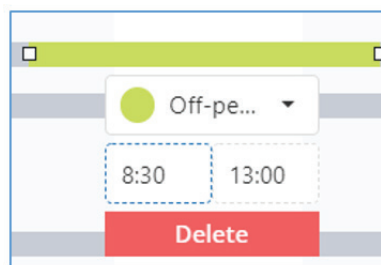

Example of rates split of a winter weekday schedule:

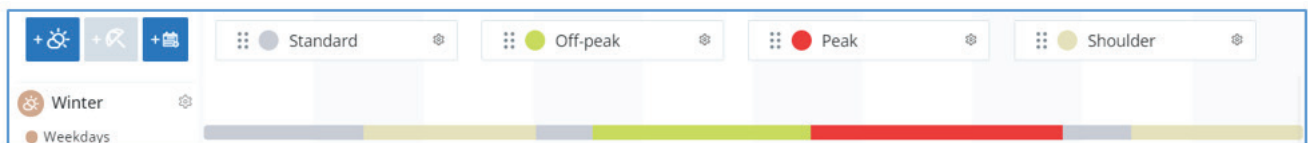

Do so for the other schedules.

Annex III - 2.4. Step 4 (Optional): Configure alternate days

You can configure up to two additional alternate days which are special days that have the highest priority compared to other schedules.

For instance if you configured weekends management, holidays and special days, in the unlikely event where a day of the year happens to be a weekend but also a holiday AND also a special day, the rate configuration that will be taken into account will be the alternate day one.

More generally:

Alternate day > Holiday > Weekend > Weekdays.

To add one alternate day click on the corresponding symbol at the top left: .

A window appears to let you select which day of the year should be treated as a special alternate day, it then appears on the calendar with the relevant color.

Annex III - 2.5. Step 5: Finalizing your configuration

When you have finished configuring your seasons, rates, optional holidays and optional alternate days, review the configuration on the bottom calendar, then click on “Apply” at the top right to send the configuration to the device:

The screenshot displays the 'Time of use' configuration interface. At the top, there are navigation options: 'Settings', 'Import / export', 'Read', and 'Apply' (highlighted with a red box and arrow). Below these are four rate categories: 'Standard' (grey), 'Off-peak' (green), 'Peak' (red), and 'Shoulder' (yellow). The main area shows a timeline from 1:00 AM to 11:00 PM with colored bars representing the configuration for different seasons: Spring, Summer, and Holidays (United States Federal Holidays). Below the timeline is a calendar view for the years 2023, 2024, and 2025, showing monthly calendars with days color-coded according to the configuration.

Annex III - 3. Viewing your time of use information

To view the energies per tariffs according to your time of use setup you can see these information on the screen by going in the Measurements > Time of use menu:



Then, you can see the energies per rate on various periods (last few billings periods, last months, last weeks, last days, ...):

TIME OF USE | Heating pump #1

From 06/11/2023 To 06/17/2023

Period	Energy
Week - 1	Ea+ 0.000000 kWh
Off-Peak	Ea- 0.000000 kWh
Energy	Er+ 0.000000 kvarh
	Er- 0.000000 kvarh
	Es 0.000000 kVAh

GO TO OVERVIEW

You can also see the max demand on each period by switching from Energy to Power.

You can also view time of use information On Webview software, in the time of use tab:

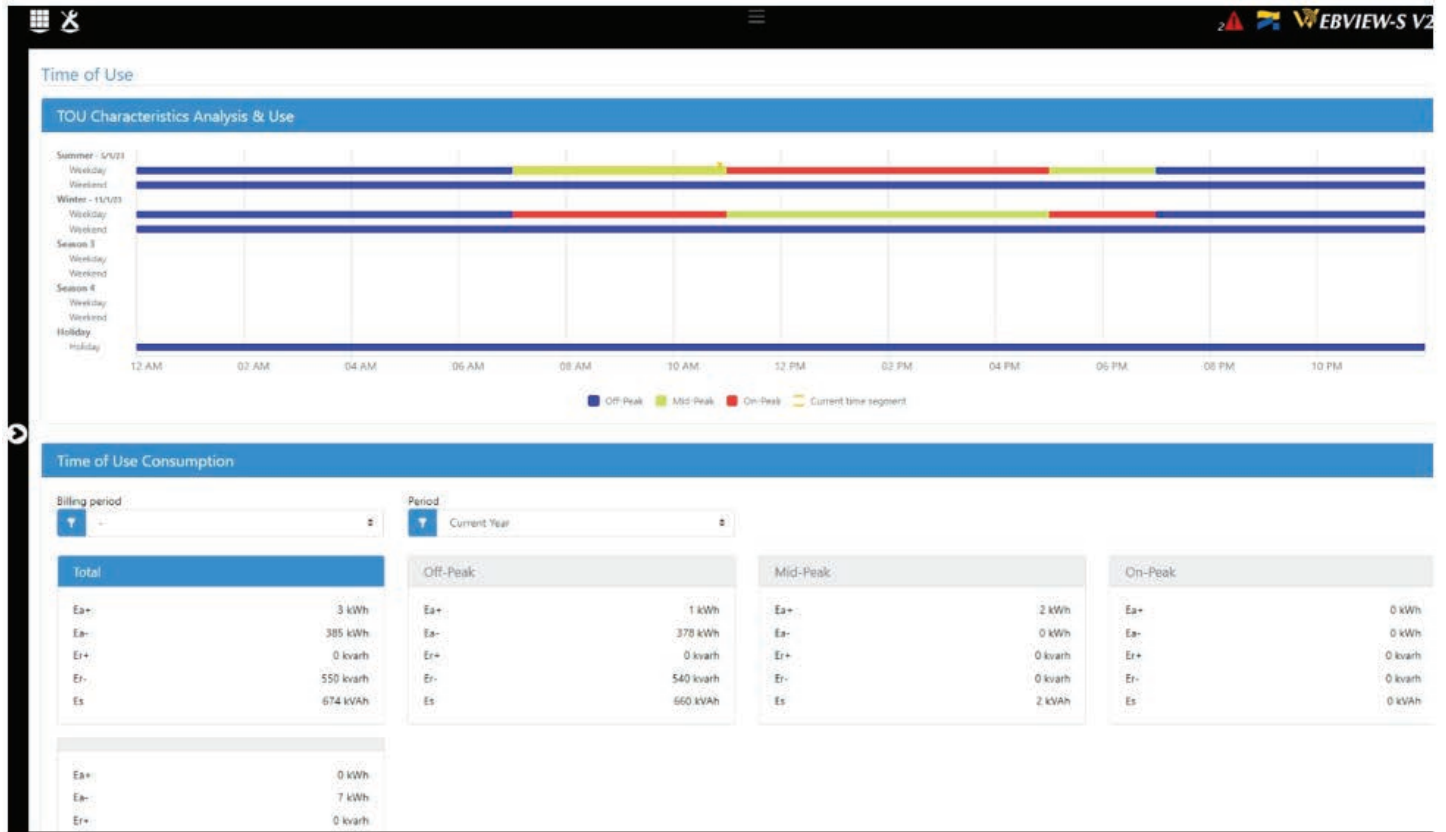

You can see the different seasons configured, and optionally if weekends and holidays are treated as special schedules, they will also show.

You can see in which schedule you are with the color highlight and arrow on the on-going rate.

You can see energies on the period you want by selecting below which billing period or which period of the year you want to see the time of use energy values from:

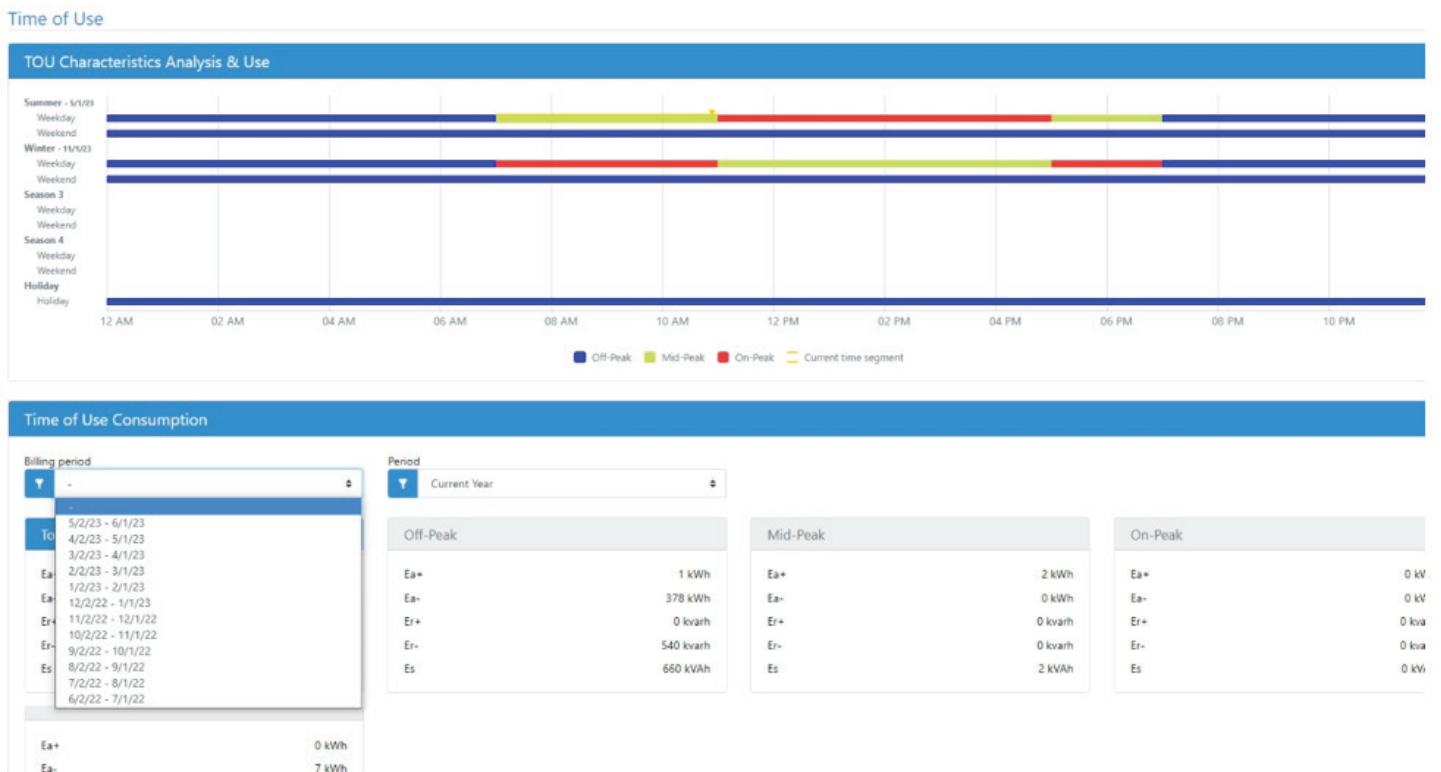

ANNEX IV. WAVEFORMS

Waveform features allow two things:

- See in real time the shape of voltage and current sinewaves (scope mode). This is possible both on screen and Webview webserver.
- Waveform captures triggered upon event ; in this case it is possible to see the shape of current and voltage sinewaves during the event, to analyze and identify the root cause of the event.

Annex IV - 1. Waveforms real-time (scope mode):

To see the real time waveforms on the screen, go to the waveforms menu on the homepage:

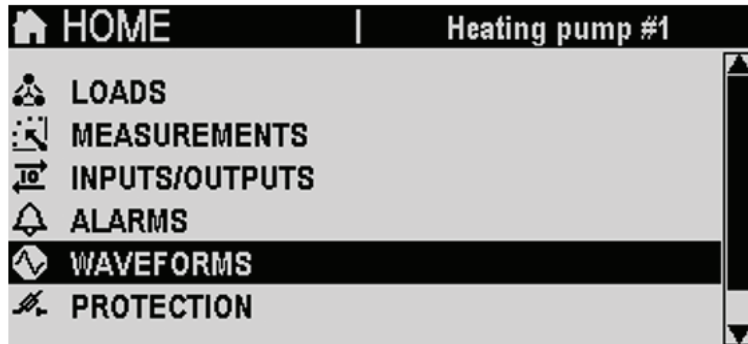

Then scope mode:

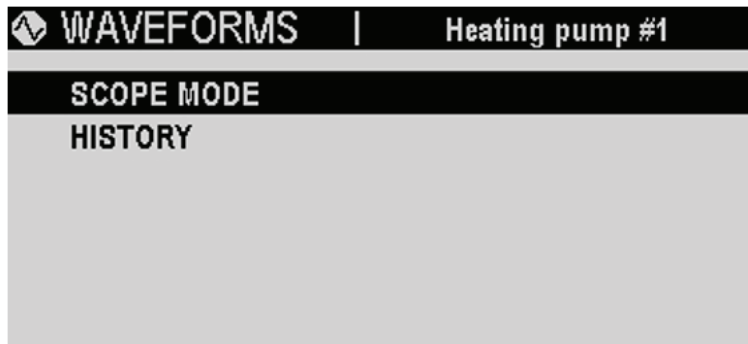

Chose which waveforms you want to display ; you can only display a maximum of three sinewaves on the same graphic:

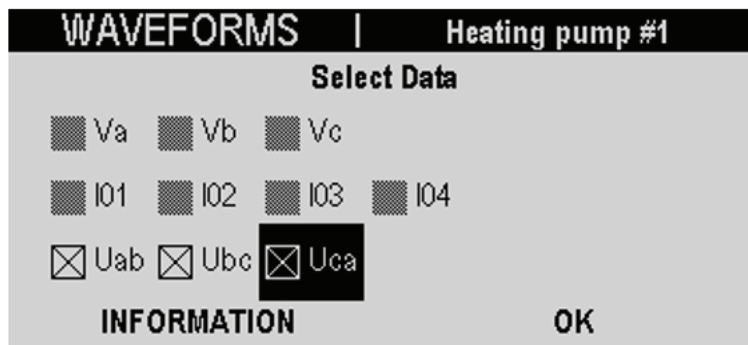

Select "OK", the waveforms are displayed and refreshed in real-time:

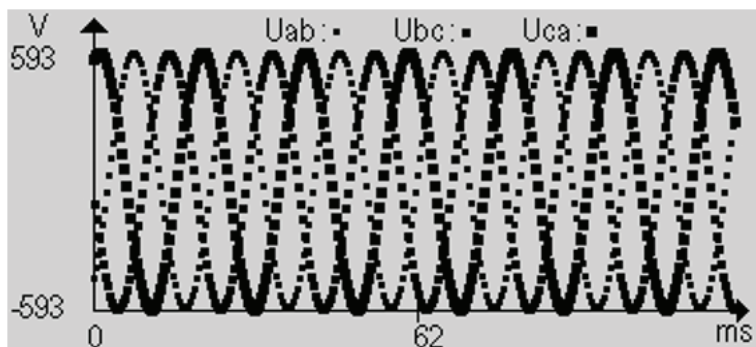

To check the real-time waveforms on Webview, go to "Scope mode":

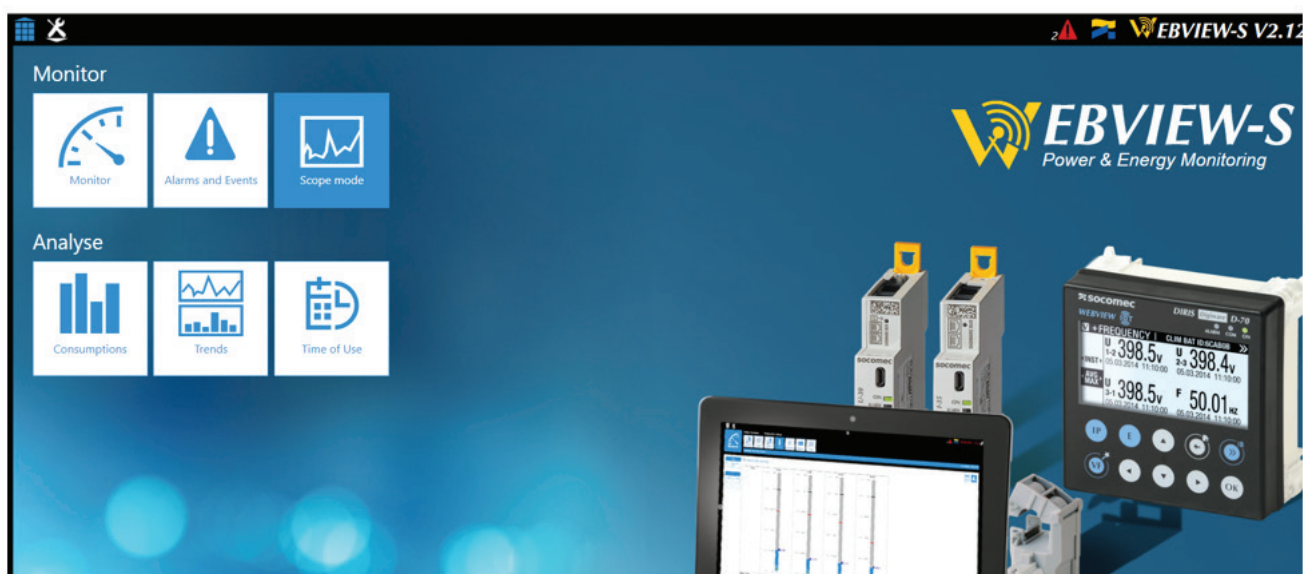

The waveforms are loading and will be displayed after a short while:

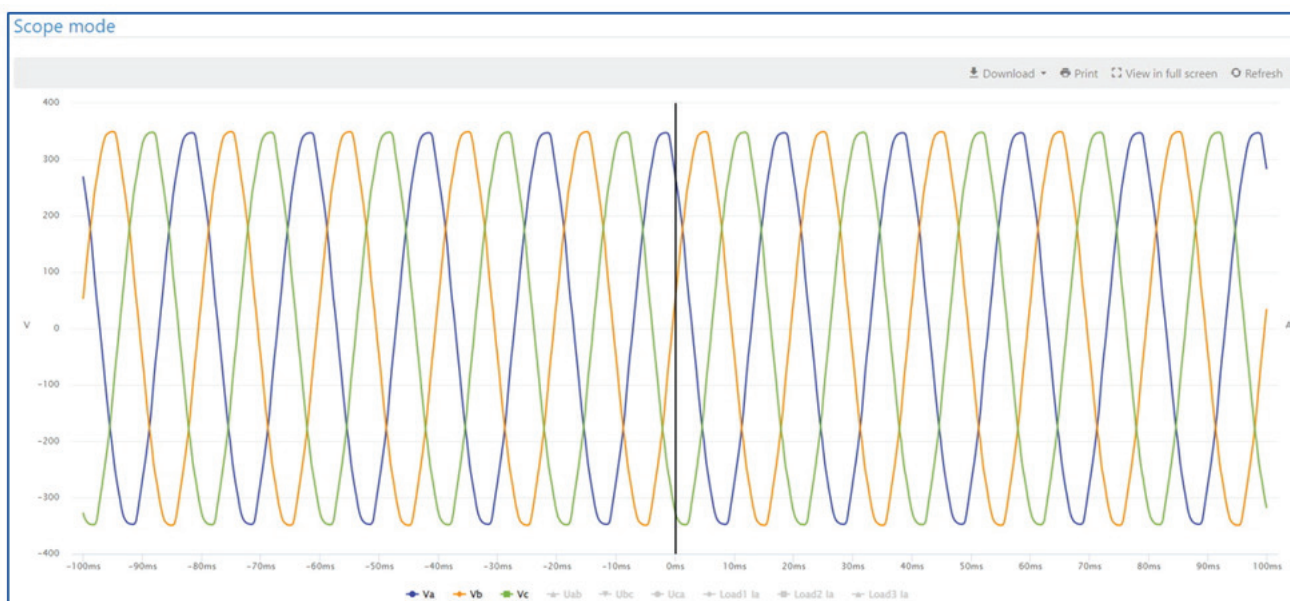

You can select which waveforms you want to display (phase-to-neutral voltages, phase-to-phase voltages or currents).

Select which waveforms you want to look at by clicking on it at the bottom of the screen:



If you want to load a new set of real-time waveforms click on refresh  at the top right of the screen.

You also have the ability to view it in full screen or export your waveform in several type of formats (CSV, picture, ...).

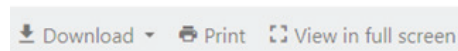

Annex IV - 2. Waveforms capture upon event

Annex IV - 2.1. General information

You can trigger capturing sets of waveforms upon a specific event happening, in this case each time the corresponding event triggers a set of waveforms are logged (10 waveforms per event: VA, VB, VC, UAB, UBC, UAC, Current line1, Current line2, current line3, current line 4).

Current lines depend on how you have configured your loads: for instance if only one three phase load with neutral is set , the current lines would be:

- load 1: Ia
- load 1: Ib
- load 1: Ic
- Load 1: In.

Alternatively, in the case where you have for instance 4 single-phase loads configured, the current lines would be:

- Load 1: Ia
- Load 2: Ia
- Load 3: Ia
- Load 4: Ia

Waveform captures trigger can be based on any the following conditions:

- Upon overcurrent ($I > 120\% I_{nom}$)
- Upon EN50160 voltage event (voltage Dip, voltage Swell, voltage Interruption)
- Upon Logical inputs state change*
- Upon Power failure in case DIRIS A-200 loses it's power

* if set to logical input , you have to manually read the waveforms through MODBUS, they will not appear neither on Webview nor on the display.

The maximum set of waveforms that can be stored in memory is 100. Each event can have 1 or 2 set of waveforms, if the duration of the event is greater than the recording max duration.

When the memory of waveforms is full, the oldest ones are erased (FIFO mode).

Annex IV - 2.2. Setup

First of all it is necessary to configure which type of condition will trigger the waveform captures, do so in Easy Config system in the “Waveform settings” menu:

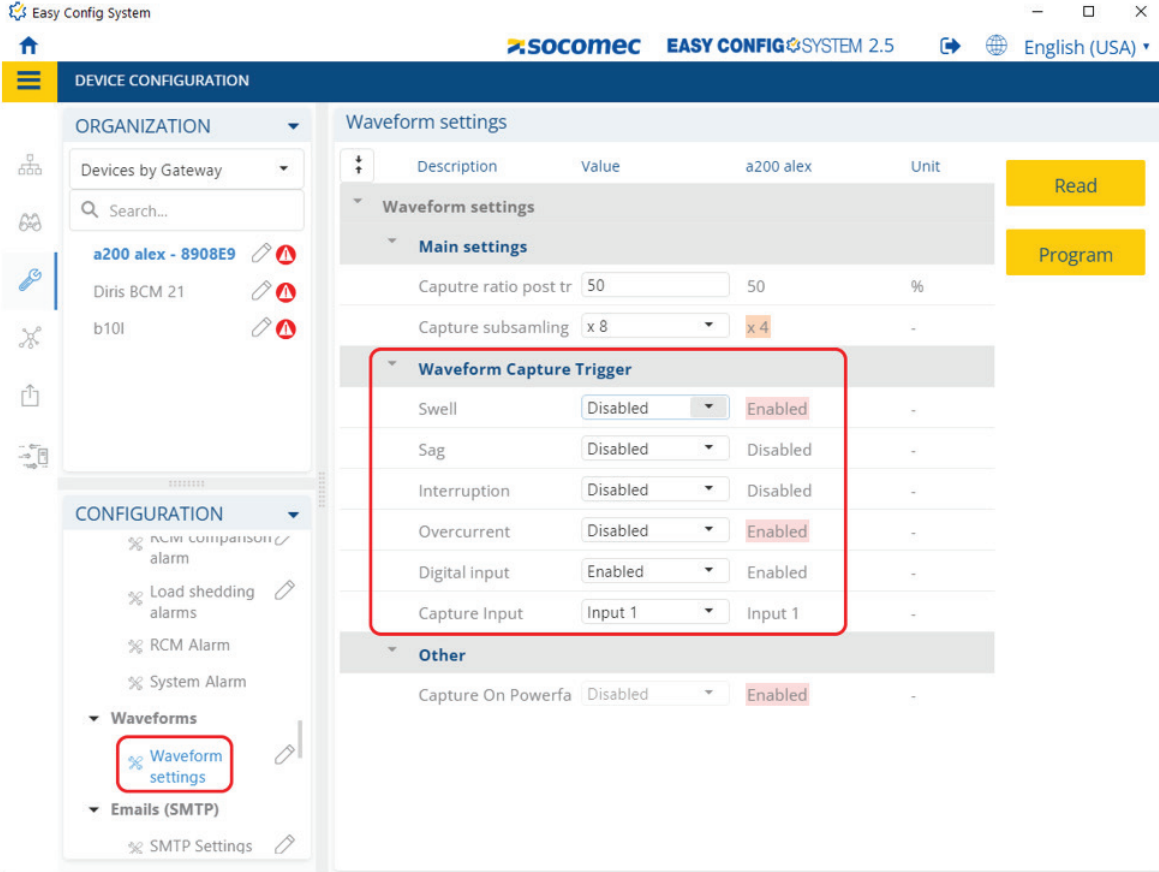

The screenshot shows the 'Easy Config System' interface for 'a200 alex - 8908E9'. The 'Waveform settings' menu is open, and the 'Waveform Capture Trigger' section is highlighted with a red box. The settings are as follows:

Description	Value	a200 alex	Unit
Waveform settings			
Main settings			
Caputre ratio post tr	50	50	%
Capture subsamling	x 8	x 4	-
Waveform Capture Trigger			
Swell	Disabled	Enabled	-
Sag	Disabled	Disabled	-
Interruption	Disabled	Disabled	-
Overcurrent	Disabled	Enabled	-
Digital input	Enabled	Enabled	-
Capture Input	Input 1	Input 1	-
Other			
Capture On Powerfa	Disabled	Enabled	-

Be careful that the trigger upon sag/interruption/swell depends on the percentage of voltage related to nominal that is set. You find this information in the “EN 50160 events” menu:

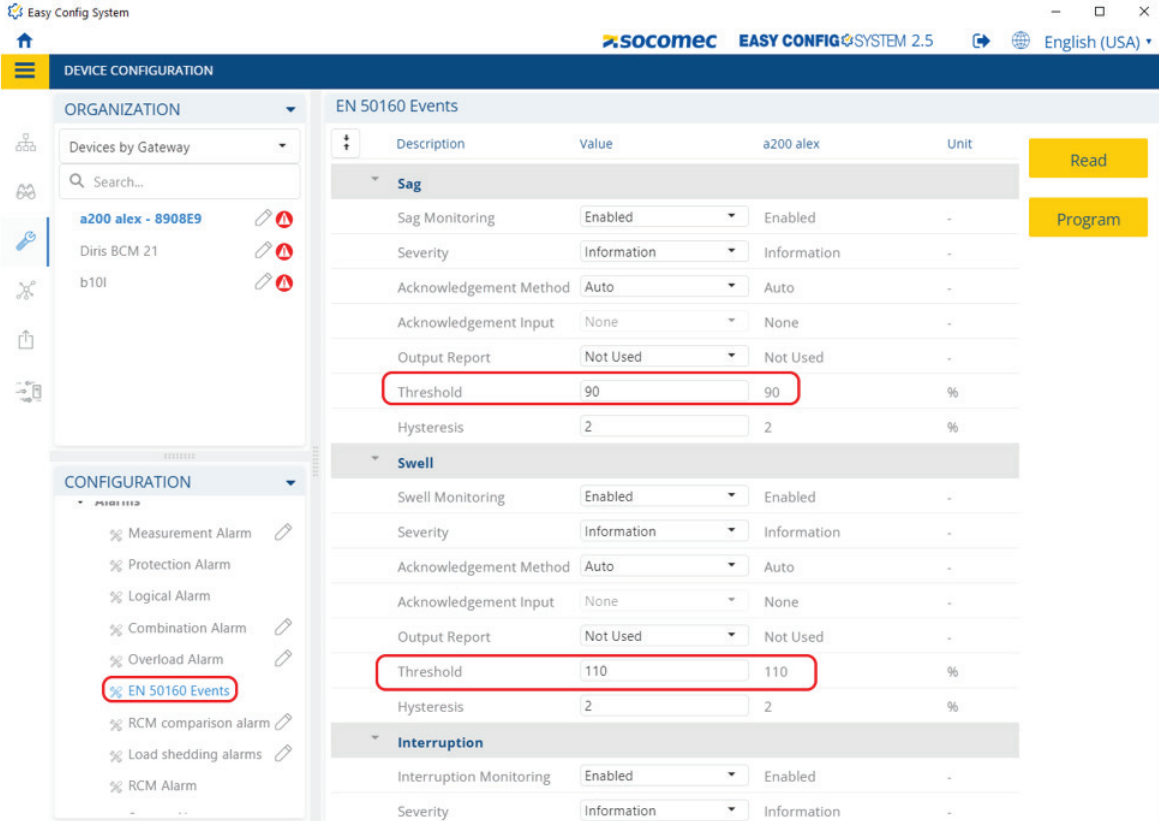

The screenshot shows the 'Easy Config System' interface for 'a200 alex - 8908E9'. The 'EN 50160 Events' menu is open, and the 'Sag' and 'Swell' sections are highlighted with red boxes. The settings are as follows:

Description	Value	a200 alex	Unit
Sag			
Sag Monitoring	Enabled	Enabled	-
Severity	Information	Information	-
Acknowledgement Method	Auto	Auto	-
Acknowledgement Input	None	None	-
Output Report	Not Used	Not Used	-
Threshold	90	90	%
Hysteresis	2	2	%
Swell			
Swell Monitoring	Enabled	Enabled	-
Severity	Information	Information	-
Acknowledgement Method	Auto	Auto	-
Acknowledgement Input	None	None	-
Output Report	Not Used	Not Used	-
Threshold	110	110	%
Hysteresis	2	2	%
Interruption			
Interruption Monitoring	Enabled	Enabled	-
Severity	Information	Information	-

By default, a sag event is triggered if voltage is lower than 90% of the configured nominal voltage and a swell is triggered if voltage is higher than 110%.

Additionally, you can change the capture ratio post trig event, from 0 to 100%.

This affects what percentage of the waveform capture is before the event starts (through a buffer) and what percentage is after the event starts.

This is useful, because usually to understand the cause of an event, it's important to have a look at the waveforms before the event actually occur.



If set to 100% the full capture will be after the event triggered. On the contrary if set to 0% the recording will be completely before the event triggers.

You can set any value from 0 to 100%.

Lastly you can change the capture subsampling from x1 to x8.

This affects the resolution of the waveforms that will be recorded. The higher the subsampling factor, the lower the number of points that will be recorded per period (20ms per period @50hz, 16,6ms per period @ 60Hz), but the longer the recording will be.

Default subsampling is x2, which means 80 points per period at 60Hz and a recording of 240ms per capture.

There are 960 samples per waveform:

Subsampling factor	Interval of time between samples	Number of point per period	Captured period count in One buffer (50Hz/60Hz)	Total capture duration buffer (50Hz/60Hz)
1	1/9600Hz ~ 104µs / pt	192 / 160	5 / 6	100ms / 120ms
2	2/9600Hz ~ 208µs / pt	96 / 80	10 / 12	200ms / 240ms
4	4/9600Hz ~ 416µs / pt	48 / 40	20 / 24	400ms / 480ms
8	8/9600Hz ~ 833µs / pt	24 / 20	40 / 48	800ms / 960ms
16	16/9600Hz ~ 1666µs / pt	10 / 12	80 / 96	1600ms / 1920ms

Be aware that if the duration of the event is greater than the total capture duration, two set of waveforms will be recorded:

- One for the beginning of the event
- One for the end of the event

Example: Voltage interruption event that lasts for 2.3 seconds. With subsampling factor x2, each set of waveforms lasts 240ms. In this case two set of waveforms will be recorded, beginning of event duration 240ms, end of the event duration 240ms:



Annex IV - 2.3. Visualization

To see the waveforms linked to your events, you can check them both in the display and on Webview.

On the screen, go to the waveform menu, then history:

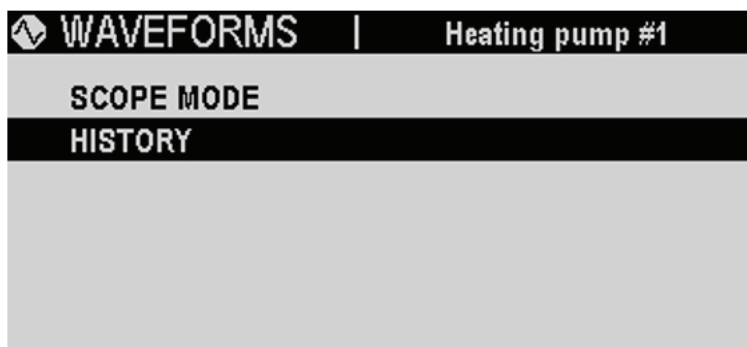

Then select in the list which event you want to see the waveform captures from:

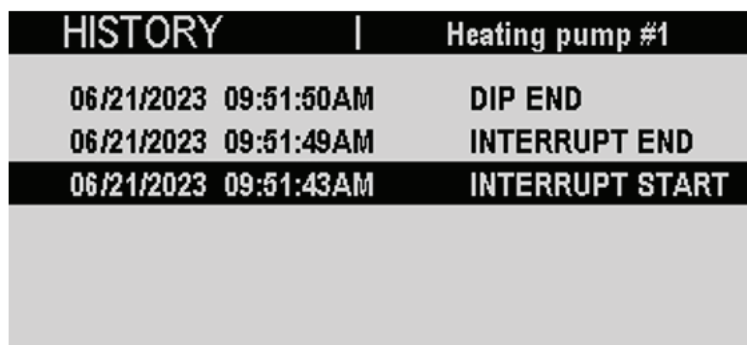

You will see the event on the screen:

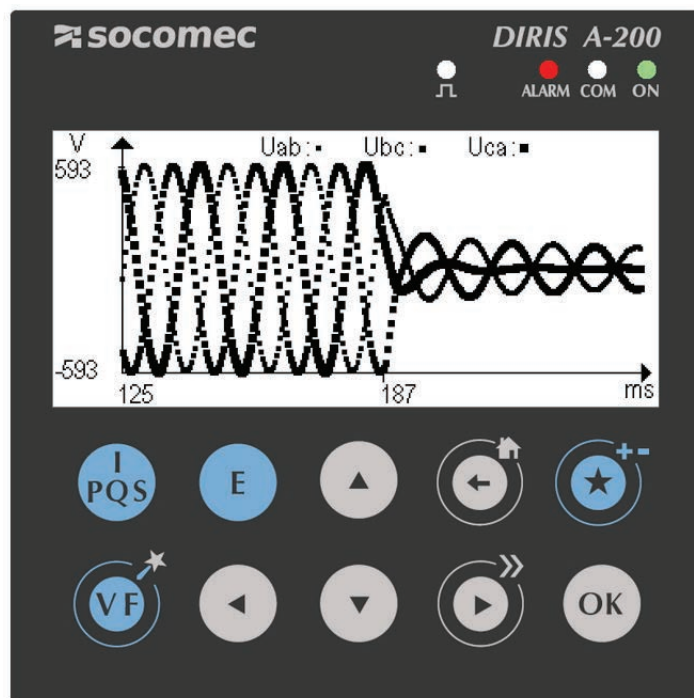

You can go to the left or right with the arrows to see the entire event:

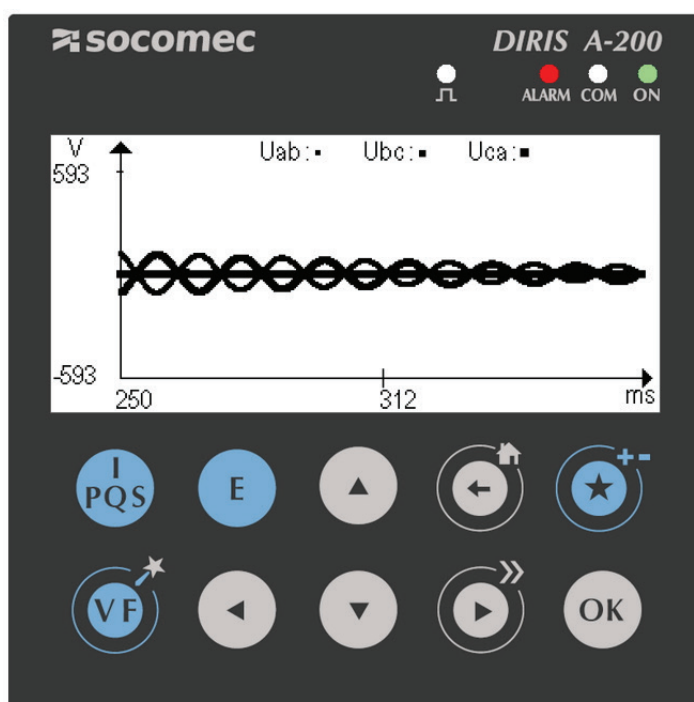

In Webview, go to the “Alarm and events” tab:



Then, filter by type “Event”:

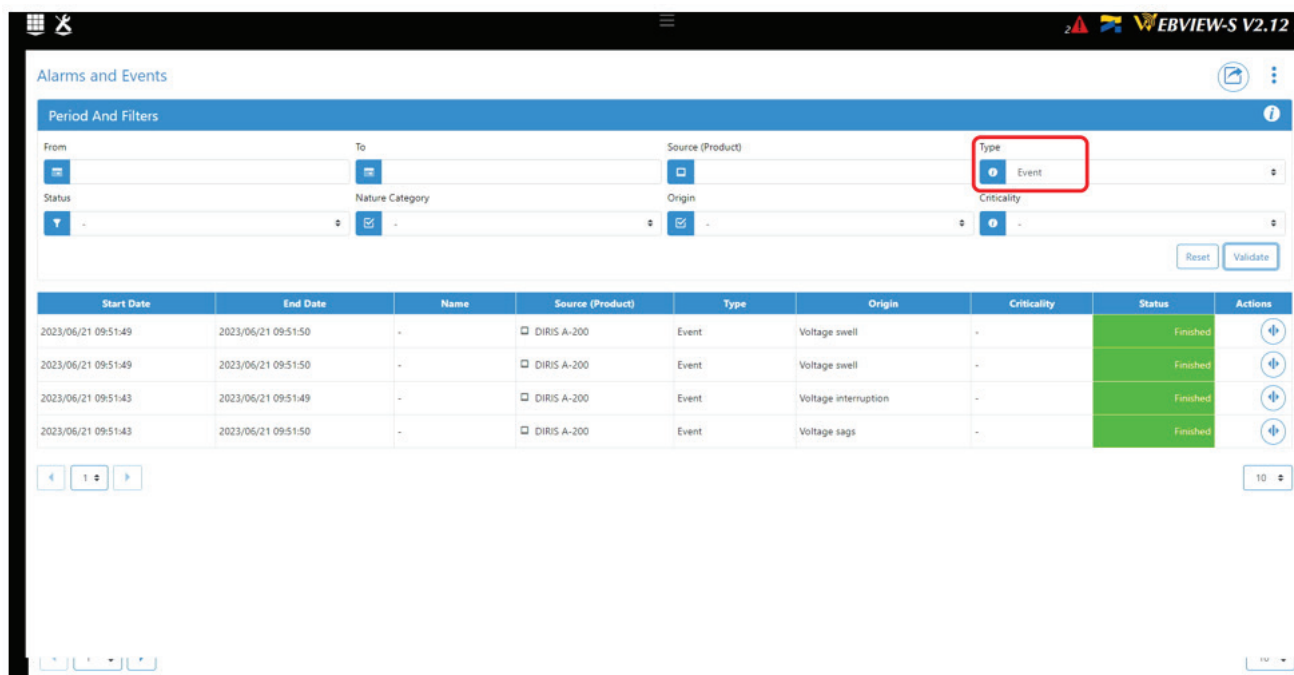

Open the detail panel on the right:

The screenshot shows the 'Alarms and Events' section of the EBVIEW-S V2.12 application. It features a 'Period And Filters' section at the top with fields for 'From', 'To', 'Source (Product)', 'Type', 'Status', 'Nature Category', 'Origin', and 'Criticality'. Below this is a table of events. The table has columns for 'Start Date', 'End Date', 'Name', 'Source (Product)', 'Type', 'Origin', 'Criticality', 'Status', and 'Actions'. The 'Status' column shows 'Finished' for all events. The 'Actions' column contains an 'Open Detail Panel' button for the 'Voltage sags' event, which is highlighted with a red box.

Start Date	End Date	Name	Source (Product)	Type	Origin	Criticality	Status	Actions
2023/06/21 09:51:49	2023/06/21 09:51:50	-	DIRIS A-200	Event	Voltage swell	-	Finished	⬇️
2023/06/21 09:51:49	2023/06/21 09:51:50	-	DIRIS A-200	Event	Voltage swell	-	Finished	⬇️
2023/06/21 09:51:43	2023/06/21 09:51:49	-	DIRIS A-200	Event	Voltage interruption	-	Finished	⬇️
2023/06/21 09:51:43	2023/06/21 09:51:50	-	DIRIS A-200	Event	Voltage sags	-	Finished	⬇️

Then click on Visualize the waveform:

The screenshot shows the 'Alarms and Events' section with the 'Visualize the waveform' button highlighted in a red box. A detail panel on the right side of the interface displays the waveform data for the selected event. The detail panel has columns for 'Field' and 'Value'.

Field	Value
Origin	Voltage sags
Name	-
Source (Product)	DIRIS A-200
Start Date	2023/06/21 09:51:43.157
End Date	2023/06/21 09:51:50.249
Status	Finished
Start of Event	Ubc
Start of Event	Uca
Start of Event	Va
Start of Event	Vc
End of Event	Vb
Ref Uab	398.30V
Amplitude Uab	369.81V
Ref Ubc	398.30V
Amplitude Ubc	321.06V
Ref Uca	398.30V
Amplitude Uca	336.39V
Ref Va	229.95V
Amplitude Va	196.74V
Ref Vb	229.95V
Amplitude Vb	232.72V
Ref Vc	229.95V
Amplitude Vc	196.63V

The waveforms will appear:

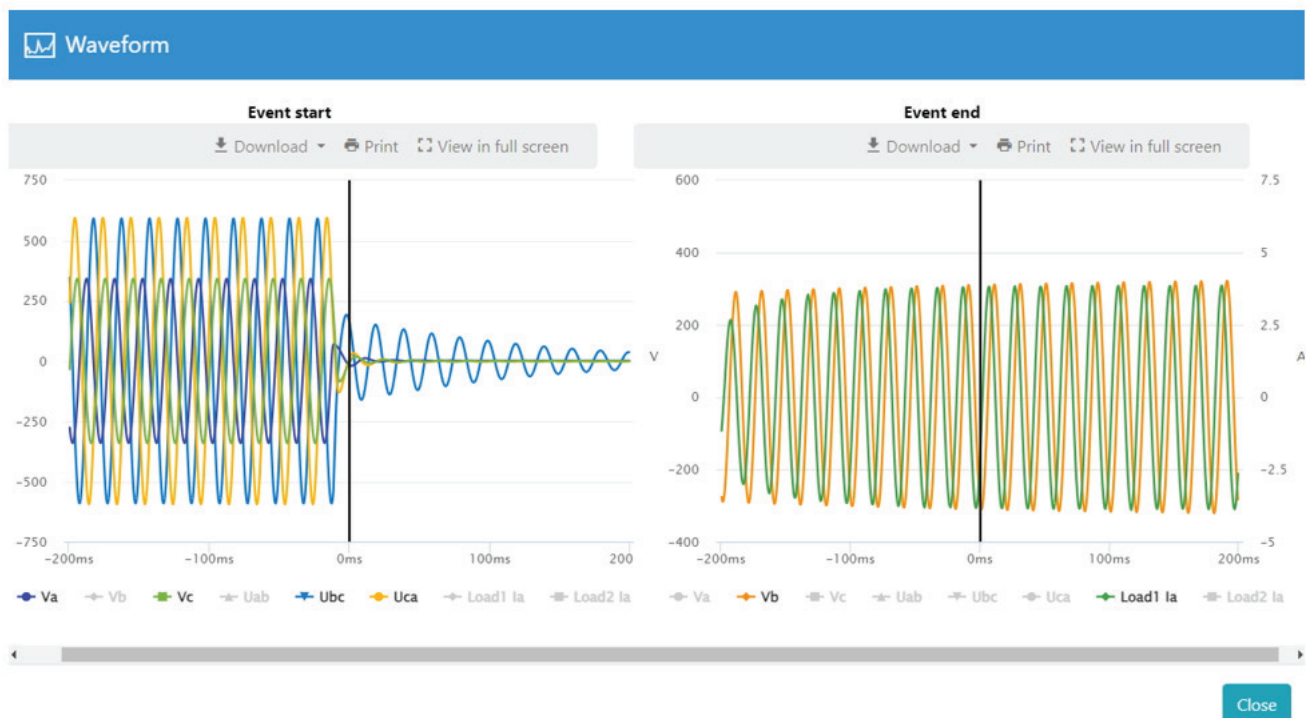

You can zoom in by selecting a zone on the graph:



CORPORATE HQ CONTACT:
SOCOMECSAS
1-4 RUE DE WESTHOUSE
67235 BENFELD, FRANCE

www.socomec.com

Non contractual document. © 2023, Socomec SAS. All rights reserved.



552138B



 **socomec**
Innovative Power Solutions